

Statistical Modeling

Michael C. Neale

Mx:

Statistical Modeling

by

Michael C. Neale

Department of Psychiatry, Virginia Institute for Psychiatric and Behavioral Genetics,
Virginia Commonwealth University, Richmond, Virginia, U.S.A.

Steven M. Boker

Department of Psychology,
University of Notre Dame, Notre Dame, Illinois, U.S.A.

Gary Xie

Department of Psychiatry, Virginia Institute for Psychiatric and Behavioral Genetics,
Virginia Commonwealth University, Richmond, Virginia, U.S.A.

Hermine H. Maes

Department of Human Genetics, Virginia Institute for Psychiatric and Behavioral
Genetics, Virginia Commonwealth University, Richmond, Virginia, U.S.A.

Virginia Institute for Psychiatric and Behavioral Genetics
Virginia Commonwealth University
Department of Psychiatry

First Published 1991
Second Edition 1994
Third Edition 1995
Fourth Edition 1997
Fifth Edition 1999

Refer to MX manual as:

Neale MC, Boker SM, Xie G, Maes HH (1999). *Mx: Statistical Modeling*. VCU Box 900126, Richmond, VA 23298: Department of Psychiatry. 5th Edition.

All rights reserved
© 1999 Michael C. Neale

Table of Contents

List of Tables	11
List of Figures	13
Preface	15
1 Introduction to	
Structural Equation Modeling	1
1.1 Guidelines for good Script Style	1
1.2 Matrix Algebra	1
1.3 Structural Equation Modeling	2
RAM Approach	2
Simplified MX Approach	6
Fully Multivariate Approach	9
1.4 Other Types of Statistical Modeling	10
2 Introduction to the	
MX Graphical User Interface	
.....	11
2.1 Using MX GUI	11
2.2 Fitting a Simple Model	12
Preparing the Data	12
Drawing the Diagram	12
Fitting the Model	13
Viewing Results	13
Saving Diagrams	16
2.3 Revising a Model	16
Adding a Causal Path	16
Adding a Covariance Path	16
Changing Path Attributes	17
Fixing a Parameter	18
Confidence Intervals	18
Equating Paths	18
Moving Variables and Paths	19
2.4 Extending the Model	19
Multiple Groups: Using Cut and Paste	19
Selecting Different Variables for Analysis	22
Modeling Means	22
2.5 Output Options	23
Zooming in and out	23
Copying Matrices to the Clipboard	24
Comparing Models	24
Setting Job Options	24
Printing	26
Exporting Diagrams to other Applications	27
Files and Filename Extensions	28

2.6	Running Jobs	28
	Running Scripts	28
	Using Networked Unix Workstations	29
2.7	Advanced Features	31
	Adding Non-linear Constraints to Diagrams	31
	Moderator Variables: Observed Variables as Paths	33
3	Outline of Mx Scripts and Data Input	37
3.1	Preparing Input Scripts	37
	Comments, Commands and Numeric Input	37
	Syntax Conventions	37
	Job Structure	38
	Single Group Example	39
	#Define Command	40
	Matrices Declaration	41
	Matrix Algebra	41
3.2	Group Types	42
	Title Line	42
	Group-type Line	42
3.3	Commands for Reading Data	43
	Covariance and Correlation Matrices	43
	Asymptotic Variances and Covariances	43
	Variable Length, Rectangular and Ordinal Files	44
	Missing Command	46
	Definition Variables	46
	Contingency Tables	46
	Means	47
	Higher Moment Matrices	47
3.4	Label and Select Variables	47
	Labeling Input Variables	47
	Select Variables	48
	Select If	48
3.5	Calculation and Constraint Groups	49
	Calculation Groups	49
	Constraint Groups	49
4	Building Models with Matrices	51
4.1	Commands for Declaring Matrices	51
	Matrices Command	51
	Matrix Types	52
	Equating Matrices across Groups	52
	Free Keyword	53
4.2	Building Matrix Formulae	55
	Matrix Operations	55
	Matrix Functions	59
4.3	Using Matrix Formulae	68
	Covariances, Compute Command	68

	Means Command	68
	Threshold Command	69
	Weight command	70
	Frequency Command	70
4.4	Putting Numbers in Matrices	71
	Matrix Command	71
	Start and Value Commands	72
4.5	Putting Parameters in Matrices	73
	Pattern Command	73
	Fix and Free Commands	73
	Equate Command	74
	Specification Command	75
	Boundary Command	76
4.6	Label Matrices and Select Variables	76
	Labeling Matrices	76
	Identification Codes	77
5	Options for Fit Functions and Output	79
5.1	Options and End Commands	79
5.2	Fit Functions: Defaults and Alternatives	79
	Standard Fit Functions	80
	Maximum Likelihood Analysis of Raw Continuous Data	82
	Maximum Likelihood Analysis of Raw Ordinal Data	83
	Contingency Table Analysis	85
	User-defined Fit Functions	86
5.3	Statistical Output and Optimization Options	87
	Standard goodness-of-fit output	87
	RMSEA	87
	Suppressing Output	88
	Appearance	88
	Residuals	88
	Adjusting Degrees of Freedom	89
	Power Calculations	89
	Confidence Intervals on Parameter Estimates	90
	Standard Errors	92
	Randomizing Starting Values	92
	Automatic Cold Restart	93
	Jiggling Parameter Starting Values	93
	Confidence Intervals on Fit Statistics	93
	Comparative Fit Indices	94
	Automatically Computing Likelihood-Ratio Statistics of Submodels	94
	Check Identification of Model	95
	Changing Optimization Parameters	95
	Setting Optimization Parameters	96
5.4	Fitting Submodels: Saving Matrices and Files	97
	Fitting Submodels using Multiple Fit Option	97

	Dropping Parameters from Model	99
	Reading and Writing Binary Files	99
	Writing Matrices to Files	100
	Formatting and Appending Matrices Written to Files	101
	Writing Individual Likelihood Statistics to Files	101
	Creating RAMpath Graphics Files	102
6	Example Scripts	103
6.1	Using Calculation Groups	103
	General Matrix Algebra	103
	Assortative Mating 'D' Matrix	104
	Pearson-Aitken Selection Formula	105
6.2	Model Fitting with Genetically Informative Data	106
	ACE Genetic Model for Twin Data	106
	Power Calculation for the Classical Twin Study	108
	RAM Specification of Model for Twin Data	110
	Cholesky Decomposition for Multivariate Twin Data	112
	PACE Model: Reciprocal Interaction between Twins	114
	Scalar, Non-scalar Sex Limitation and Age Regression	116
	Multivariate Assortative Mating: Modeling D	119
6.3	Fitting Models with Non-linear Constraints	119
	Principal Components	119
	Analysis of correlation matrices	120
	Fitting a PACE Model to Contingency Table Data	122
	Twins and their Parents: Cultural and Genetic Transmission	124
6.4	Fitting Models to Raw Data	131
	Estimating Means and Covariances	131
	Variable Pedigree Sizes	132
	Definition Variables	133
	Using NModel to assess heterogeneity	135
	Least Squares	140
	Correction for Ascertainment	140
A	Using MX under different operating systems	143
A.1	Obtaining MX	143
A.2	System Requirements	143
A.3	Installing the MX GUI	143
A.4	Using MX	143
B	Error Messages	147
B.1	General Input Reading	147
B.2	Error Codes	147
C	Introduction to Matrices	155
C.1	The Concept of a Matrix	155
C.2	Matrix Algebra	156

	Transposition	156
	Matrix Addition and Subtraction	156
	Matrix Multiplication	157
C.3	Equations in Matrix Algebra	160
C.4	Calculation of Covariance Matrix from Data Matrix	161
	Transformations of Data Matrices	163
	Determinant of a Matrix	164
	Inverse of a Matrix	165
D	Reciprocal Causation	169
E	Frequently Asked Questions	173
	References	175
	Index	181

List of Tables

2.1	Correspondence between optimization codes and IFAIL parameter	13
2.2	Summary of filename extensions used by MX	28
3.2	Parameters of the group-type line	42
4.1	Matrix types	52
4.2	Syntax for constraining matrices to special quantities	53
4.3	Examples of use of the Matrices command	54
4.4	Matrix operators	55
4.5	Matrix functions	60
5.1	Default fit functions	80
6.1	Summary of parameter estimates for a variety of models of heterogeneity ..	136

List of Figures

1.1	Example path diagram	3
1.2	Multivariate path diagram	7
2.1	MX GUI with Project Manager Window	11
2.2	The Results Panel	13
2.3	The Results Box Panel	14
2.4	MX Path Inspector	17
2.5	Starting values for an ACE twin model for MZ twins	21
2.6	Parameter estimates from fitting the ACE model	21
2.7	The Job Option Panel	25
2.8	Host Options Panel	30
2.9	Higher Order Factor Model	31
2.10	Linear Regression with Interaction Model	34
2.11	Linear Regression with Interaction	35
3.1	Factor model for two variables	39
5.2	Contour plot showing a bivariate normal distribution	85
6.1	ACE genetic model for twin data	106
6.2	Cholesky or triangular factor model	112
6.3	PACE model for phenotypic interaction	114
6.4	Model for sex limitation and age regression	116
6.5	Three factor model of 9 cognitive ability tests	121
6.6	Model of mixed genetic and cultural transmission	124
6.7	Definition variable example	134
C.1	Graphical representation of the inner product	158
C.2	Geometric representation of the determinant	164
D.1	Feedback loop between two variables	169
D.2	Structural equation model for x variables	170
D.3	Structural equation model for y variables	171

Preface

What MX does

MX is a structural equation modeling package, but it is flexible enough to fit a variety of other mathematical models. At its heart is a matrix algebra processor, which can be used by itself. There are many built-in fit functions to enable structural equation modeling and other experiments in matrix algebra and statistical modeling. It offers the fitting functions found in commercial software such as LISREL, LISCOMP, EQS, SEPATH, AMOS and CALIS, including facilities for maximum likelihood estimation of parameters from missing data structures, under normal theory. Complex 'nonstandard' models are easy to specify. For further general applicability, it allows the user to define their own fit functions, and optimization may be performed subject to linear and nonlinear equality or boundary constraints.

How to Read this Manual

The bad news is that this manual is quite long; the good news is that you don't need to read it all! Chapter 1 contains an introduction to multivariate path modeling. The "how to" part of the manual starts in Chapter 3, in which general syntax conventions and job structure are laid out, followed by description of the commands necessary to read data. Chapter 4 deals with the heart of MX: how to define matrices and matrix algebra formulae for model-fitting, and ways of estimating and constraining parameters. Methods of changing the default fit-function, of decreasing and increasing the quantity (and quality) of the output, and for fitting sub-models efficiently, are described in Chapter 5. The last chapter supplies and briefly describes a number of example scripts. The Appendices describe the use of MX under different operating systems, error codes, introductory matrix algebra and reciprocal causation.

Origin

The development of MX owes much to LISREL and I acknowledge the pioneering effort put in by Karl Jöreskog & Dag Sörbom. There are many who have supported and encouraged this effort in many different ways. I thank them all, and especially Lindon Eaves, Ken Kendler and John Hewitt since they also provided grant support¹, and David Fulker for allowing modification of his notes on matrix algebra to be supplied as an appendix to this manual. Jack McArdle and Steve Boker provided excellent path diagram drawing software (RAMPATH) which was the basis for the development of MX Graph, Luther Atkinson suggested the binary file save option; Buz Brown programmed the Rectangular file read, Karen Kenny and John Fritz organized the interactive website; these efforts were part of the excellent software, hardware and consultancy support supplied by University Computing Services at the Medical College of Virginia, Virginia Commonwealth University. The MX

¹ The author was supported by ADAMHA grants MH-40828, MH-45268, AG-04954, MH-45127 and RR-08123

team includes my colleagues Drs. Steve Boker, Hermine Maes, Mr. Gary Xie and Wayne Hadady.

What's New in 1999

New in this edition is the MX Graphical interface documentation. Chapter 2 describes how to take advantage of this software which is available for the MS Windows (Win3.x/98/NT) platform. Jobs built with diagrams or scripts can be executed on a Unix server to get results more quickly for CPU intensive modeling.

Several features have been added to enable modeling ordinal data. `P ?` is the ordinal file command, which operates like a rectangular file read except that it expects ordinal data with a lowest category of zero. Likelihoods are then computed using numerical integration software provided by Genz (1992). The same software is used in the latest function which returns all of the cell proportions for a covariance matrix and set of thresholds.

A new frequency command (described on `p ?`) supplements the weight command by allowing different cases to have different weights. This feature allows data-weighting approaches to be implemented.

A number of new features improve the quantity and quality of statistical and matrix output. First, the difference between a supermodel and a submodel can be computed automatically if the option `Issat` is used to identify a supermodel, or if option `sat` is used to enter the fit of a supermodel against which new models are to be compared. Matrix output can be formatted with any legal Fortran format, and matrices written can be appended to existing files. This latter feature is useful for simulation work because the results of several model-fitting runs can be written to the same file for later analysis.

Several new examples have been added, both to the text and to the MX website. It is a pleasure to continue to offer MX free of charge, which allows rapid fixing of bugs and immediate release of new features.

Internet Support

MX is public domain; it is available from the internet at <http://griffin.vcu.edu/mx/>. With a suitable browser, you can obtain the program, documentation and examples, send comments, see the latest version available for your platform, and so on. E-mail bug reports, requests for further information, and *most important* your comments and suggestions for improvements to neale@psycho.psi.vcu.edu - it is hard to overemphasize the importance of constructive criticism. You can also grab the code for a variety of operating systems via anonymous ftp to [opal.vcu.edu](ftp://opal.vcu.edu). Please have the courtesy (and self-interest) to E-mail me so that I can keep you informed of updates, bug reports etc.

A graphical interface for structural equation modeling, "MX Graph" is currently in alpha-test to MX that will relieve the user of getting to grips with the details of scripts. Even with this interface, knowledge of the script language is necessary to use advanced features and methods. The good news is that a much deeper understanding of modeling can come from

this activity. We are in the process of revising the script language to enhance its flexibility and readability.

Technical Support

A number of users have been most helpful finding errors in the documentation or software or both, and for suggesting new features that would make MX easier to use. Thank you! I hope that all users will forward any comments, bug reports, or wish-lists to me. My current address is:

address Department of Psychiatry
Virginia Institute for Psychiatric and Behavioral Genetics
Box 126 MCV
Richmond VA 23298-0126, USA

phone 804 828 3369

fax 804 828 1471

E-mail neale@psycho.psi.vcu.edu (*internet*)

and my order of preference for communication is E-mail, fax, phone and snail mail. When reporting problems, E-mail is especially useful to include the problem file.

To find	Go to
Matrix Algebra Learn basic Syntax	Appendix C
SEM Path Analysis	Neale & Cardon (1992) chapter 5 Loehlin (1987) McArdle & Boker (1990) Everitt (1984)
How to do basic SEM	Chapter 1
How to recast basic SEM more efficiently	Chapter 1
How to use the graphical interface	Chapter 1
Job Structure	Chapter 3
Reading Data	Chapter 3
Declare Matrices Use Matrix Formulae	Chapter 4
Use different Fit Functions, Write Output to Files Change Options	Chapter 5
Look through Example Scripts	Chapter 6

Quick Check of Syntax

Index
Quick Reference Guide

Operating Systems

Appendix A

Icons

Meaning



Caution



Note



Efficiency tip

1 Introduction to Structural Equation Modeling

What you will find in this chapter

- Guidelines for building your own scripts
- A brief introduction to the capabilities of MX.
- Three different ways to implement a structural equation model in MX

1.1 Guidelines for good Script Style

Programming, like much of life, requires compromises. We must balance the time taken to do things against their value. Now, there are both short-term considerations (“how do I get this working as soon as possible?”) and long-term ones (“how can I save time in what I’m going to be doing next week?”). This usually results in making a choice of method that is based on the following factors:

- Time taken to get the script working properly
- Clarity, which can affect time to debug and modify
- Efficiency of the script - how fast it runs
- Flexibility - how easy it is to alter.

Normally, we would choose a method that will solve our problem in the shortest time. If we expect to use the same basic model but with a varying number of observed and latent variables, then it is worth spending the extra time to write a script in which these changes can be made easily.

Part of writing good scripts is to write them so that you, or colleagues can understand them. Sometimes readability can be at the expense of efficiency, and it is up to you to decide on the balance between the two. One of the most important things to remember is to put plenty of comments in your scripts. Doing so can seem like a waste of time, but it usually pays off handsomely when the scripts are read by yourself or others at a later date.

1.2 Matrix Algebra

MX will evaluate matrix algebra expressions. It has a simple language, which uses single letters to represent matrices, certain characters to represent matrix operations, and a special syntax to invoke matrix functions. Thus the program can be used as a matrix algebra calculator, which is helpful in a variety of research and educational settings, and which provides a powerful way to specify structural equation and other mathematical models. Most users of multivariate statistics will need to know some matrix algebra, and Appendix I gives a brief introduction to the subject, along with examples and exercises which use MX. Even those familiar with matrix algebra should review the “How to do it in MX” sections in the appendix as that is where elementary principles of writing MX scripts are introduced.

1.3 Structural Equation Modeling

One of the most common uses of MX is to fit Structural Equation Models (SEM) to data. A nice aspect of SEM is that the models can be represented as a path diagram. MX Graph incorporates path diagram drawing software directly; this software is in α -test. For now, we concentrate on translating path diagrams into models ‘by hand’. This approach has the advantage of giving greater understanding of the modeling process, and can yield highly efficient scripts which are easy to change when, for example, the number of variables changes.

There are many accounts of SEM, which vary widely in complexity and clarity, and which are aimed at different fields of study or different software packages (Jöreskog, K.G. & Sörbom, 1991; Bentler, 1989; Everitt, 1984; Loehlin, 1987; McArdle & Boker 1990; Bollen 1992; Neale & Cardon 1992; Steiger, 1994). The brief account given here is intended to provide a practical guide to setting up models in MX for those with some familiarity with path analysis or SEM. We begin with a simple, foolproof method, called RAM (McArdle & Boker 1990) which would be ideal except that it is inefficient for the computer to fit. More efficient approaches will follow.

RAM Approach

A path diagram consists of four basic types of object: circles, squares, one-headed and two-headed arrows. Circles are used to represent latent (not measured) variables;² and squares correspond to the observed (or measured) variables. In a path diagram, two types of relationship between variables are possible: causal and correlational. Causal relationships are shown with a one-headed arrow going *from* the variable that is doing the causing *to* the variable being caused. Correlational or covariance relationships are shown with two headed arrows. A special type of covariance path is one that goes from the variable to itself. Variation in a variables which is not due to causal effects of other variables in the diagram is represented by this self-correlational path. Sometimes this is called ‘residual variance’ or ‘error variance’.

Figure 1.1 shows a sample path diagram with two latent variables and four observed. The RAM model specification involves three matrices: **F**, **A** and **S**. **S** is for the symmetric paths, or two-headed arrows, and is symmetric. **A** is for the asymmetric paths, or one-headed arrows, and **F** is for filtering the observed variables out of the whole set. The dimensions of these matrices are fixed by the number of variables in the model. **A** and **S** are both $m \times m$, and **F** is $m_o \times m$, where $m = m_o + m_L$ is the total number of variables in the model, m_o the number of observed variables, and m_L the number of latent variables. In our example we have $m_o = 4$, $m_L = 2$ and $m = 6$.

² The use of the term ‘variable’ here may be somewhat confusing to those familiar with operations research and numerical optimization. In numerical optimization, a variable is something that is to be changed to find the optimum. In SEM, these are called ‘free parameters’ or simply ‘parameters’.

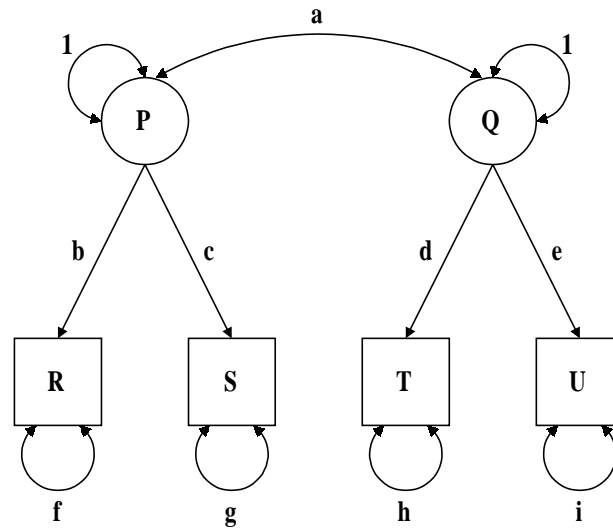

Figure 1.1 Example path diagram with two latent variables (P and Q) and four observed variables (R, S, T, U)

$$\mathbf{A} = \begin{matrix} & \begin{matrix} P & Q & R & S & T & U \end{matrix} \\ \begin{matrix} P \\ Q \\ R \\ S \\ T \\ U \end{matrix} & \begin{pmatrix} 0 & 0 & 0 & 0 & 0 & 0 \\ 0 & 0 & 0 & 0 & 0 & 0 \\ b & 0 & 0 & 0 & 0 & 0 \\ c & 0 & 0 & 0 & 0 & 0 \\ 0 & d & 0 & 0 & 0 & 0 \\ 0 & e & 0 & 0 & 0 & 0 \end{pmatrix} \end{matrix}, \quad \mathbf{S} = \begin{matrix} & \begin{matrix} P & Q & R & S & T & U \end{matrix} \\ \begin{matrix} P \\ Q \\ R \\ S \\ T \\ U \end{matrix} & \begin{pmatrix} 1 & a & 0 & 0 & 0 & 0 \\ a & 1 & 0 & 0 & 0 & 0 \\ 0 & 0 & f & 0 & 0 & 0 \\ 0 & 0 & 0 & g & 0 & 0 \\ 0 & 0 & 0 & 0 & h & 0 \\ 0 & 0 & 0 & 0 & 0 & i \end{pmatrix} \end{matrix}$$

$$\mathbf{F} = \begin{matrix} & \begin{matrix} P & Q & R & S & T & U \end{matrix} \\ \begin{matrix} R \\ S \\ T \\ U \end{matrix} & \begin{pmatrix} 0 & 0 & 1 & 0 & 0 & 0 \\ 0 & 0 & 0 & 1 & 0 & 0 \\ 0 & 0 & 0 & 0 & 1 & 0 \\ 0 & 0 & 0 & 0 & 0 & 1 \end{pmatrix} \end{matrix}.$$

and Note how \mathbf{F} is an elementary matrix of 1's and 0's with a 1 wherever the row variable is the same as the column variable.

Now that we have defined these matrices, computing the predicted covariance matrix under this model is relatively simple. The formula is:

$$\mathbf{F}(\mathbf{I}-\mathbf{A})^{-1} \mathbf{S} (\mathbf{I}-\mathbf{A})^{-1'} \mathbf{F}'$$

which is easy to program in MX and is quite general. So, suppose that we have measured R , S , T and U on a sample of 100 subjects, and computed the covariance matrix. How would we fit the model in Figure 1.1 to these data, using the above formula? A sample script might look like this:

```

!
! Simple RAM approach to fitting models
!
#Ngroups 1
#define latent 2          ! Number of latent variables
#define meas 4           ! Number of measured variables
#define m 6              ! Total number of variables, measured + latent

Title Ram approach to fitting models      ! Title
Data NInput=meas NObserved=100          ! Number of variables, subjects
CMatrix File=ramfit.cov                 ! Reads observed covariance matrix

Matrices;                               ! Declares matrices
  A Full m m                             ! One-headed paths
  S Symm m m                             ! Two-headed paths
  F Full meas m                          ! Filter matrix
  I Iden m m                             ! Identity matrix
End Matrices;                            ! End of matrix declarations

Specify A                                 ! Set certain elements of A as free parameters
  0 0 0 0 0 0
  0 0 0 0 0 0
  1 0 0 0 0 0
  2 0 0 0 0 0
  0 3 0 0 0 0
  0 4 0 0 0 0
Specify S                                 ! Set the free parameters in S
  0
  5 0
  0 0 6
  0 0 0 7
  0 0 0 0 8
  0 0 0 0 0 9
Value 1.0 S 1 1 S 2 2                    ! Put 1's into certain elements of S
Matrix F                                  ! Do the same for Matrix F but a different way
  0 0 1 0 0 0                             ! Note - this could be omitted if F had
  0 0 0 1 0 0                             ! been declared ZI instead of full.
  0 0 0 0 1 0
  0 0 0 0 0 1
Start .5 All                              ! Supply .5 starting value for all parameters

Covariance F & ((I-A)~ & S); ! Formula for model
End group

```

This script is organized into six sections: (i) defines, (ii) title and data reading, (iii) declaring matrices, (iv) putting parameters into matrices, (v) putting numbers into matrices and (vi) the formula for the model. More detail on all these components can be found in the body of the manual, but let's look at some of the basic features.

- Anything after ! is interpreted as a comment. Blank lines are inactive but serve to visually separate the sections of the script.
- The #define statement is used to preassign numbers to certain strings of letters. After a command like #define latent 2, MX will interpret 'latent' as 2 whenever it is trying to read a number. #NGroups indicates the number of groups in the script.
- The Title line is required.
- The Data line is required and supplies essential information about the number of variables to be analyzed (NInput_vars) and the number of subjects measured (Nobservations).
- The CMatrix statement reads in the observed covariance matrix from a file, in lower triangular format. The file ramfit.cov might look like this:
*
1.51
.31 1.17
.22 .19 1.46
.11 .23 .34 1.56
where the * indicates free format.
- The Matrices line is required and starts the declaration of matrices that will be used in the covariance statement. We make use of the #define'd words to get them the right size.
- Specify puts free parameters into matrices. All the usable elements of the matrix are listed (i.e. only the lower triangle for symmetric matrices, or only the diagonal elements for diagonal matrices). A zero indicates that the element is fixed, and a positive integer indicates that it's free. Different positive integers represent different free parameters; if we wished to have parameters 1 and 2 set equal, we would replace the 2 with a 1.
- The fixed values of 1 for the variances of the latent variables are given with a Value statement.
- Start .5 all sets all the free parameters to .5 as an initial guess of the parameter estimates.

- The Covariance statement supplies the formula for the model. We have used the & operator for quadratic matrix multiplication ($A \& B = A * B * A'$), to make the script more efficient. It would work equally well, and only slightly more slowly with the full expression $F * (I - A)^{-1} * S * (I - A)^{-1} * F'$ given above.
- End group marks the end of the script.

What are the advantages and disadvantages of setting up models with the RAM method? On the positive side, it is extremely simple and general. It doesn't matter if there are feedback loops, everything will be specified correctly (see Appendix D). Of course, some care may be required with the choice of starting values, but we do have a practical method. On the negative side, the covariance statement involves inverting the $(\mathbf{I} - \mathbf{A})$ matrix, which will be slow when we have many variables or a slow computer. Many models do not need to use matrix inversion in the covariance statement. In fact, it is only feedback loops which make this necessary; we can therefore seek a simpler, more efficient specification of the model. There are many of these, but we shall be aiming for one that is systematic and straightforward.

Simplified Mx Approach for Models without Feedback Loops

Consider Figure 1.1 again. It has two *levels* of variables: P and Q at level 1, and R, S, T and U at level 2. We could put all the two-headed arrows at the first level in one matrix, all the level 1 to level 2 arrows in a second matrix, and all the two-headed level 2 arrows in a third matrix. Letting these matrices be \mathbf{X} , \mathbf{Y} and \mathbf{Z} respectively, we would get:

$$\mathbf{X} = \begin{matrix} & \begin{matrix} P & Q \end{matrix} \\ \begin{matrix} P \\ Q \end{matrix} & \begin{pmatrix} 1 & a \\ a & 1 \end{pmatrix} \end{matrix}, \quad \mathbf{Y} = \begin{matrix} & \begin{matrix} P & Q \end{matrix} \\ \begin{matrix} R \\ S \\ T \\ U \end{matrix} & \begin{pmatrix} b & 0 \\ c & 0 \\ 0 & d \\ 0 & e \end{pmatrix} \end{matrix} \quad \text{and} \quad \mathbf{Z} = \begin{matrix} & \begin{matrix} R & S & T & U \end{matrix} \\ \begin{matrix} R \\ S \\ T \\ U \end{matrix} & \begin{pmatrix} f & 0 & 0 & 0 \\ 0 & g & 0 & 0 \\ 0 & 0 & h & 0 \\ 0 & 0 & 0 & i \end{pmatrix} \end{matrix}$$

It so happens that all the observed variables are at the same level (2) in this model, which makes life easy for us. Although it may seem that we have artificially contrived the model to have this desirable feature, many structural equation models can be written this way. The covariance formula for this model is:

$$\mathbf{Y} \mathbf{X} \mathbf{Y}' + \mathbf{Z}$$

and this has a very simple multivariate path diagram to represent it, as shown in Figure 1.2. To get from Figure 1.1 to Figure 1.2 all we did was to collapse the vector of variables within each level to form a single vector of variables at each level. The paths are collapsed into matrices of paths.

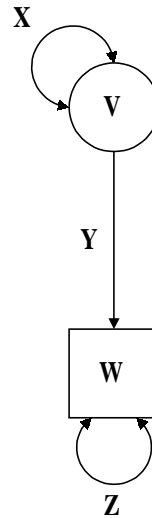

Figure 1.2 Multivariate path diagram for the system shown in Figure 1.1.

Exercises:

1. Fit the model using the simpler **X**, **Y** and **Z** specification.
2. Find the change in chi-squared when the parameters b and c are set equal
3. Pick a simple published model and data and fit it with MX with the RAM approach
4. Find a more efficient method to fit the model in 3.

To best learn how to use MX, readers should attempt the exercises themselves before reading the next section, which describes the answer to the first exercise.

```

!
! Mx partly simplified approach to fitting models
!
#Ngroups 1
#define top 2          ! Number of variables in top level
#define bottom 4       ! Number of variables in bottom level

Title Mx simplified approach to fitting model ! Title
Data NInput=bottom NObserved=100          ! Number of variables,subjects

CMatrix File=ramfit.cov      ! Reads observed covariance matrix
Matrices;                    ! Declares matrices
  X Stan top top free        ! Two-headed, top level
  Y Full bottom top          ! From top to bottom arrows
  Z Diag bottom bottom free  ! Two-headed, bottom level
End Matrices;                ! End of matrix declarations

Specify Y                    ! Declare certain elements of Y as free parameters
  31 0
  32 0
  0 33
  0 34
Start .5 All                 ! Supply .5 starting value for all parameters

Covariance Y*X*Y' + Z;      ! Formula for covariance model
End group

```

What tricks have we used here? First, the keyword `Free` in the matrix declaration section makes elements of matrices **X** and **Z** free. Matrix **X** is standardized, which means that it is symmetric with 1's fixed on the diagonal, so free parameter number 1 goes in the lower off-diagonal element (the upper off-diagonal element is automatically assigned this free parameter as well, because standardized matrices are symmetric). Matrix **Z** is diagonal, so it will have parameters 2 through 5 assigned to its diagonal elements. We could put parameters 6 through 9 in matrix **Y**, but 31 to 34 are used instead, just to emphasize that we don't want our specification numbers to overlap with specifications automatically supplied by MX when the free keyword is encountered at matrix declaration time.

Note how this script is much shorter than the original, because of the reduced need for specification statements to put parameters into matrices. This illustrates a valuable feature of programming with MX: with appropriate matrix formulation of the model, specification statements can be eliminated. The advantage of setting up models in this way is that modifying the model to cater for a different number of observed or latent variables becomes trivially simple. The more complex the model, the greater the value of this approach. Another advantage is that the computer time required to evaluate the model can be greatly reduced. We have not only eliminated the need for matrix inversion when the predicted covariance matrix is being calculated, but also reduced the size of the matrices that are being multiplied.

Fully Multivariate Approach

We now turn to a third implementation of the same model to show how the matrix algebra features can be used to make an efficient script which can be easily modified. Take another look at Figure 1.1. The first latent factor, P , causes the first two observed variables, S and T , whereas the second factor, Q , only affects the other two observed variables, U and V . Perhaps we expect to change the number of observed variables in one or other of these sets. If so, we might want to split the causal paths into two matrices, one for each factor. So, what was matrix \mathbf{Y} in the simplified MX approach will be partitioned into 4 pieces:

- the effects of P on S and T
- the effects of P on U and V (zero)
- the effects of Q on S and T (zero)
- the effects of Q on U and V

We'll use a separate matrix for each of these, and use definition variables to make the changes in their dimensions automatic.

```
!
! Mx multivariate approach to fitting models
!
#Ngroups 1
#define top 2           ! Number of variables in top level (P,Q)
#define left 2          ! Number of variables in bottom left level (R,S)
#define right 2         ! Number of variables in bottom right level (T,U)
#define meas 4
!
Title Mx simplified approach to fitting model ! Title
Data NInput=meas NObserved=100             ! Number of variables & subjects
CMatrix File=ramfit.cov                    ! Reads observed covariance matrix

Matrices;                                  ! Declares matrices
  X Stan top top free                      ! Two-headed, top level
  J Full left 1 free                       ! From P to R,S arrows
  K Zero left 1                            ! From Q to R,S (zeroes)
  L Zero right 1                           ! From P to T,U (zeroes)
  M Full right 1 free                      ! From Q to T,U arrows
  Z Diag meas meas free                   ! Two-headed, bottom level
End Matrices;                              ! End of matrix declarations
Start .5 All                               ! Supply .5 starting value for all parameters

Begin Algebra;
  Y = J|K _
      L|M ;
End Algebra;

Covariance Y*X*Y' + Z;                    ! Formula for model
End group
```

So, the major change here is to use the algebra section to compute matrix \mathbf{Y} . We have eliminated the need for a specification statement by applying the keyword `free` to matrices \mathbf{J} and \mathbf{M} . If we thought that we might expand the model to have more than one factor for each side, then we could further generalize the script by changing the matrix dimensions from 1 to `#define'd` variables.

1.4 Other Types of Statistical Modeling

The example in this chapter only deals with fitting a structural equation model to covariance matrices, but MX will do much more than this! There are many types of fit function built in to handle different types of data for structural equation modeling, including:

- Means and covariance matrices
- Correlation matrices with weight matrices
- Contingency tables
- Raw data

Also, the program's multigroup and algebra capabilities cater for tests of heterogeneity, nonlinear equality and inequality constraints, and many other aspects of advanced structural modeling.

MX has a powerful set of matrix functions and a state-of-the-art numerical optimizer, which make it suitable to implement many other types of mathematical model. One crucial feature makes this possible — user-defined fit functions. The program will optimize almost anything. Given familiarity with matrix algebra and the basics of MX syntax, it is often much quicker to implement a new model with MX than to write a FORTRAN or C program specifically for the task. A slight drawback is that the MX script may run more slowly than a purpose built programs, although this is usually well worth the saving in development time.

2 Introduction to the MX Graphical User Interface

What you will find in this chapter

How to use MX Graphical User Interface (GUI) to:

- Draw path diagrams
- Automatically create and run scripts from diagrams
- View & print results on diagrams
- Run MX scripts
- View output in Project Manager, HTML or text formats
- Edit and debug MX scripts
- Compare results and export them to other programs.

2.1 Using Mx GUI

MX GUI can be started by double clicking the MX icon in either the group window in Windows 3.xx, or from the Start menu in Windows 95. In Windows 95 you may drag the MX 32 icon from the explorer to the desktop to create a shortcut, which will simplify starting the program.

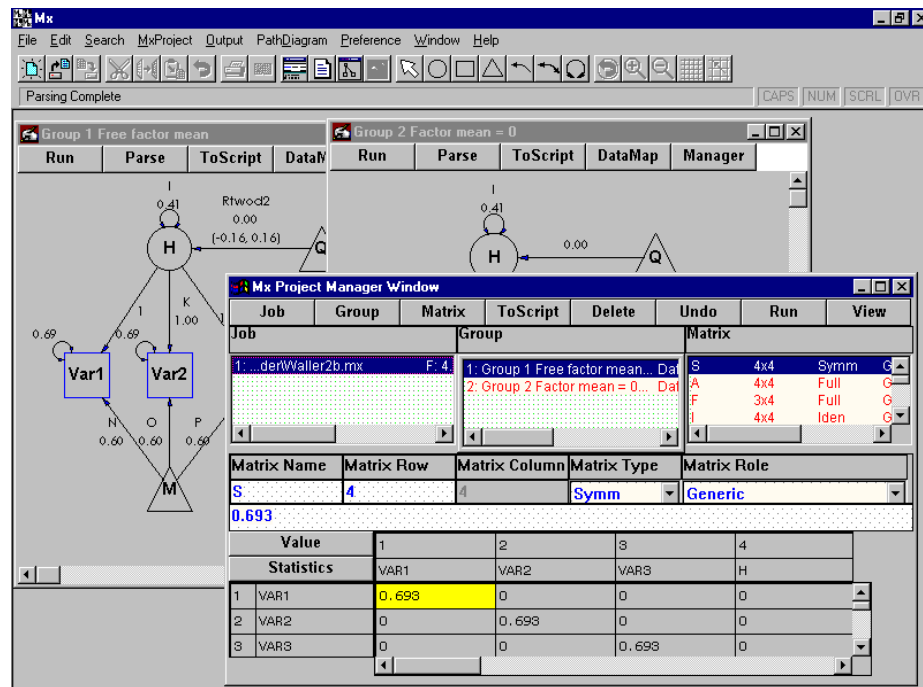

Figure 2.1 MX GUI with Project Manager Window and two diagram windows open

Figure 2.1 shows a diagram of the layout of the MX GUI when the Project Manager window is active. The button bar icons are grouped into: filing, editing, printing, running, and drawing. As with any GUI you are free to behave as you like, clicking on buttons in any order. There are, however, some logical ways to proceed that will save time. The purpose of this chapter is to demonstrate the capabilities of the interface and how to use it efficiently.

You can draw path diagrams at any time during an MX session. A diagram which is either visible in a window or minimized is called *open*. An MX script can be automatically created from all open diagrams, sent to the Project Manager, and run. Parameter estimates will be displayed in the diagrams.



Path diagrams are models of latent variables (circles) and observed variables (squares), which are related by causal (one-headed) and covariance (two-headed) paths. While diagrams can be drawn and printed in the abstract, to fit models we must attach – or ‘map’ – our data to the squares. Mapping data is the best starting point for drawing a diagram.

2.2 Fitting a Simple Model

Preparing the Data

We start with a simple dataset: a covariance matrix based on a sample of 123 subjects measured on two variables, *X* and *Y*. This information is entered in a *.dat* file, which for those familiar with MX notation, contains the *Data*, *CMatrix*, and *Labels* part of an MX script:

```
Data Ninput=2 Nobservations=123
CMatrix
.95
.55 1.23
Labels X Y
```

This file is supplied with MX Gui; *biv.dat* was installed in the *examples* subdirectory of the MX installation directory. For details on how to use other types of data, see chapter 3. To create the file yourself, any text editor, such as Microsoft's Edit program or Notepad will do. There is a text editor built into the MX GUI, and by choosing the menu item **File|New**, or clicking the new file icon , a new file can be edited and saved from the **File** menu or by clicking the save file . If the file is created with a wordprocessor such as Wordperfect or Word, it must be saved as ASCII text.

Drawing the Diagram

To start a new diagram, click on the ‘new drawing’ icon  then click the button marked **DataMap**. Then click the *biv.dat* file to open. The program then shows a list of the variables in this file. You can highlight one or more of these variables by using click, shift-click, click and drag, or control-click – the usual Microsoft Windows conventions. Get both *X* and *Y* highlighted by positioning the pointer over the *X* variable, pressing the left mouse button down, dragging it to the *Y* variable, and then releasing the mouse button. *X* and *Y* should now be highlighted in blue. Hit **New** and two new observed variables will appear in the diagram ready for analysis (they may have appeared behind the data map window). Click **Close** to close the data map window.

Note that the variables are created with variance paths  (small double-headed arrows). These paths represent residual variance; they are sometimes called autocorrelational paths. This is called a ‘null model’. It has only variances and no covariances.

Fitting the Model

Click **Run** to run this job. You will have to supply a job name and a file name. Enter `null` for both, without any file extension. MX GUI will then build, save and run the script file `null.mx`. In addition MX automatically saves the diagram into the file `null.mxd` which can be reloaded later.

While the job is running, a counter appears. The numbers it displays show that the MX engine is still trying to solve the problem. When it has finished the message ‘Parsing to Core’ may appear, indicating that the graphical interface is busy interpreting the results. Often this step is so fast that it is invisible.

Viewing Results

Results Panel

After the job has run, the Results Panel appears (see Figure 2.2). It contains information about the status of the optimization; in this example, the words ‘Appears OK’ should be on the top line, meaning that the solution it found is very likely to be a global minimum³.

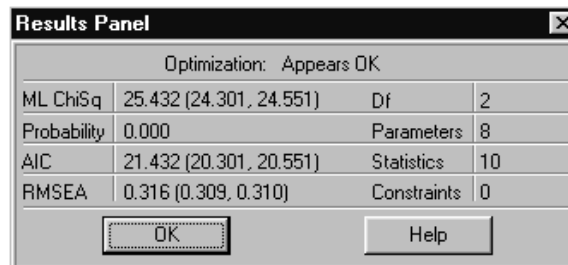

Figure 2.2 The Results Panel to view the results

Table 2.1 Correspondence between optimization codes and IFAIL parameter

Optimization Code	IFAIL	Serious	Action
Failed! Incomputable	-1	Yes	Check output & script for errors
Appears OK	0 or 1	No	Carefully accept results
Failed! Constraint Error	3	Yes	Check output & script for constraint errors
Failed! Too few iterations	4	Yes	Restart from estimates
Possibly Failed	6	Sometimes	Restart from estimates
Failed! Boundary Error	9	Yes	Send script & data to neale@psycho.psi.vcu.edu

³ For reference, other possible Optimization conditions are shown in Table 2.1.

The next line indicates the type of fitting function used, ML ChiSq, which is the usual Maximum Likelihood fit function for covariance matrices, scaled to yield a χ^2 goodness-of-fit of the model. The χ^2 is 39.546 in this example, with lower and upper 90% confidence intervals of 21.564 and 62.957 respectively. There is one degree of freedom, and the model fits very poorly ($p=.000$). There are two free parameters estimated (the two variance parameters) and three observed statistics (the two variances and the covariance). Akaike's Information Criterion (AIC) is greater than zero, reflecting poor fit. This impression is supported by the RMSEA statistic, which should be .05 or less for very good fit, or between .05 and .10 for good fit. The high value of .538 for RMSEA, and its 90% confidence intervals which do not overlap regions of good fit (0.393 is greater than .10) indicate that the model does not fit well. Click on the **OK** to remove the Results Panel. The Results Panel can be reviewed later by selecting the **Output|Fit Results** option.

Viewing Results in the Diagram

When the Results Panel closes, the estimates of the variance parameters for this model become visible in the diagram, on the double-headed arrows. The results panel information has been copied into the diagram. These results can be deleted entirely (click on the results box in the diagram and hit delete or ctrl-x) or the specific elements may be selected for viewing and printing. To display only the fit and p-value we would double click the results box to bring up the results box and change the selections as shown in Figure 2.3. If the null option in the **Preferences|Job** options panel (see p 24) was used to these data, the grayed-out fit statistics would be available for display in the diagram.

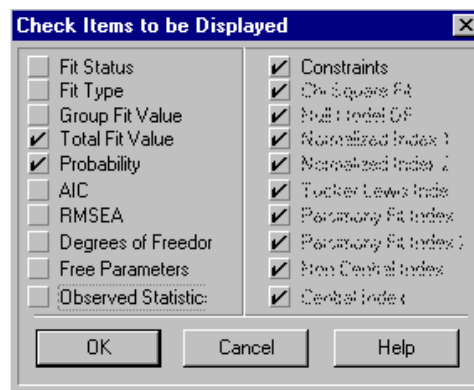



Figure 2.3 The Results Box Panel to Change the results displayed in the diagram

Project Manager

More information about this model can be found in the Project Manager – click the **Manager** button (or the toolbar icon , to open this window. Highlighted, the script file name is in the left panel, the group name is in the middle panel, and the first matrix in this group is in the right hand panel. The values in this matrix are shown in the Matrix Spreadsheet at the bottom of the Project Manager window.

Fit statistics for the model are shown in the left-hand panel of the manager, F: 39.546 being the value reported in the Results Panel. You can see the degrees of freedom, df: 1, in the left-hand Project Manager panel as well, but depending on your display you may have to use

the slider at the bottom of the panel or resize the window to see them. More information on the fit of the model can be seen in the matrix spreadsheet at the bottom of the Project Manager by clicking the **Statistics** button. Click on **Statistics** again to toggle the view back to the highlighted matrix.

In the middle panel is a list of the groups in the job – there's only one group in this case. In the right hand panel is a list of matrices used to define the model (I, A, F and S), along with the observed covariance matrix (ObsCov), expected covariance matrix (ExpCov) and the residual, ObsCov-ExpCov (ResCov). If you click on the ObsCov matrix you can see the data matrix in the matrix spreadsheet at the bottom of the Project Manager. This view of the selected matrix can be turned on and off with the **View** button on the right of the manager. As described below these matrices can be copied to the clipboard with ctrl-c.

The matrix spreadsheet can show not only the values of the matrix (and its labels) but also the parameter specifications. If you click on the **Value** button, the parameter specifications will be shown. Try this out for the S matrix. This is the matrix of Symmetric arrows (two-headed). There are two of these, one going from X to X and one going from Y to Y. The *free* parameters are numbered 1 and 2 in the specs view of the S matrix. A parameter numbered zero is *fixed*. The A matrix contains the A symmetric paths (single-headed, causal arrows) which run from column variable to row variable. There are no causal paths in this model, so all of the elements of A are zero.

Click on ExpCov in the right hand panel. To the right is the formula used for this model. Models built from diagrams currently use one general formula for the covariance:

$$\text{ExpCov} = \mathbf{F}(\mathbf{I}-\mathbf{A})^{-1} \mathbf{S} (\mathbf{I}-\mathbf{A})^{-1'} \mathbf{F}'$$

which is written using the quadratic operator & in the MX matrix language: F&((I-A)~&S) Beginners don't need to know how these formulae are used to fit the model. Details are given in Chapter 1, or see McArdle & Boker (1990) for a more complete description of this formulation.

Click on the ResCov matrix in the right hand panel. Notice how the diagonal elements of this matrix are very small. They are presented in scientific notation so 1.23e-08 means .0000000123 and this indicates a good fit of the model to these elements. The model does not fit the off-diagonal elements at all well. It predicts no covariance between these variables, but .55 is quite substantial covariance with this sample size --- as is shown by the fit statistic of $\chi^2=39.55$ for 1 df. The model should be revised.

Resizing the Project Manager

The Project Manager window may be resized by pulling the side, top, bottom or corner of it to a new position. It is also possible to resize the proportion of the window that displays jobs by dragging⁴ the bottom of the group panel up or down to a new position. Also, the **View** button will switch the matrix spreadsheet on and off.

⁴ To drag something, move the mouse pointer over it, press down the left mouse button, move it to its new position, then release the mouse button.

Saving Diagrams

All open diagrams are automatically saved to file when the job is run, but sometimes it is useful to save diagrams manually. The null model diagram could be saved directly (without running it) using the following steps:

- Click on the diagram to select it
- Click on the save-to-disk icon  (or use the **File|Save** menu item)
- Enter a filename such as null1.mxd (.mxd is the default extension for MX diagrams, which will be added automatically if you enter null without .mxd at the end). Note that all active (minimized or displayed) diagram windows are saved to the file.

See page 28 for details on running and saving scripts.

2.3 Revising a Model

Revising models is easy with the graphical tools.



Adding a Causal Path



Returning to the null path diagram, a linear regression model can be devised by adding a causal path from the independent variable, X, to the dependent variable, Y. It may clarify the path estimates to put more space between the variables. Click on the open space to de-select all the variables. Then click on Y and move it a little to the right (if you want to keep it aligned with X, press shift throughout the operation). Now click on the arrow tool icon  on the icon bar. In the diagram window, click on X, hold the mouse button down and drag it to Y, and release the button. The diagram should now have an arrow from X to Y. Usually we want these arrows to be straight, but sometimes it is useful to make them curved, which can be done by dragging the little blue square in the middle.

You can now hit **Run** in the diagram window. Enter regress for the Job name. Note that if instead you enter null as the jobname, it will overwrite the previous MX script and diagram files. This overwriting approach is useful when trying to get a model correctly specified initially, but it is better to keep substantively different models in different diagram and script files. Doing so also allows comparison between them.

The model fits perfectly, as seen by the ML ChiSq of zero in the Results Panel. It also has zero degrees of freedom, because it has the same number of parameters as it does observed statistics. Such a model is often called ‘saturated’. Click on **OK** to view the new estimates in the diagram.

Adding a Covariance Path

The procedure to add a covariance path is essentially the same as for adding a causal path, but you use the covariance drawing tool instead. Note that there are two types of covariance path: variance  which appears as a little loop from a variable to itself, and covariance . We'll add the covariance type to the diagram.

First, delete the causal path by selecting the pointer tool (the white arrow ) click on the path once (a blue dot will appear in the middle of the path to show that it is selected) and press delete or ctrl-x (cut). Note that you can undo a mistake with the undo tool , and that tool-changes can be accomplished via a right mouse button click on a diagram.

Second, add the covariance path by selecting the covariance tool . Then click on X, drag the pointer to Y, and release. The path is automatically curved a certain amount. The curvature can be increased or decreased by dragging the blue dot in the middle of the path. Single-headed arrows can be made to curve in the same way, but their default follows the convention that they are straight lines, and we recommend keeping them that way if possible (reciprocal interaction between two variables A→B and B→A requires some curvature to stop the lines being on top of each other).

Third, hit **Run** to rerun the model. Enter covar as the name of the job and script. Again this model fits perfectly, with zero degrees of freedom. The parameter estimates are not all the same as the regression model we fitted earlier. These two models may be called ‘equivalent’ because they always explain the data equally well, and a transformation can be used to obtain the parameter estimates of one model from the other.

Changing Path Attributes

A variety of characteristics of paths can be changed and made visible in the diagram with the Path Inspector. Double-click the covariance path that we just created in the diagram to bring up the Path Inspector. Using the Inspector a path can be fixed, bounded, or equated to other paths. Confidence intervals can be requested, and the display of labels, start values and other information can be switched on or off. These changes can be made to several paths at once by selecting them all and checking the ‘Apply to All Selected’ box in the Path Inspector.

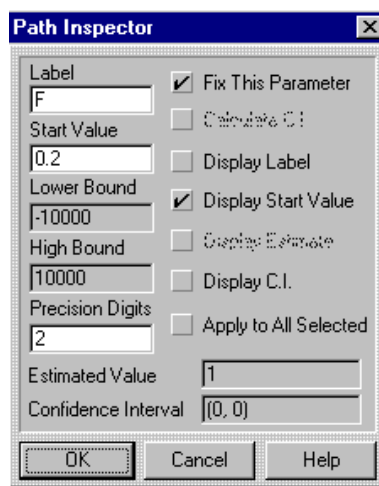

Figure 2.4 MX Path Inspector with parameter F fixed at .2

Fixing a Parameter

For illustration, we will test the hypothesis that the covariance between X and Y is equal to point two. In the Path Inspector panel for the covariance arrow check (✓) “Fix This Parameter.” Double click the start value field and type in .2 to give the fixed value for this path. One useful way to remember that a path is fixed is to display only the start value and not the path label. Uncheck the “Display Label” box and check the “Display Start Value” box. At the end your Path Inspector panel should look like Figure 2.4. Click OK and then click **Run** in the diagram window to rerun the model. Enter a new job name such as *fixed*.

If you now look at the Project Manager and click **Statistics**, you can see the fit of this model and compare it with the other models so far. Note that the Path Inspector also allows you to change the boundaries to restrict path estimates to lie in a particular interval. To constrain a parameter to be non-negative, we would simply change the lower bound to zero.

Confidence Intervals

For any free parameter you can request confidence intervals. Just double click on the path, and check the “Calculate CI” and the “Display CI” boxes in the inspector. Run the model again, but this time just click **OK** without entering a new job name so that the job overwrites the existing one in the manager. After all, we are fitting the same model and simply calculating a few more statistics. MX computes likelihood-based confidence intervals which have superior statistical properties to the more common type based on derivatives. Chapter 5 describes the method used, and Neale & Miller (1997) discuss the advantages of using this type of confidence interval. The main disadvantage is that they are relatively slow to compute, so we suggest computing them only when the model is finally correctly specified.

Equating Paths

MX uses the Labels of the paths to decide whether or not they are constrained to be equal. To illustrate, add a latent variable to the diagram, and draw causal paths from it to both X and Y, and constrain the two paths to be equal. First click on the Circle tool , and click on the diagram to add the circle. Second, click on the causal path tool and add the two paths from the new latent variable to X and Y. Third, click on one of the paths and give it the same label as the other. Finally, to make the model identified we should delete the covariance (double-headed) path between X and Y. On running it, we should find the same perfect fit ($\chi^2=0$) of the model. This time we have the square root of the covariance of X and Y as estimates for the two paths.

Note that the latent variable we added had an variance path with the *fixed* value of 1.00 on it. This is different from the observed variables, which come with *free* variance paths, corresponding to residual error variance.

Having a fixed variance of 1.00 makes our latent variables standardized by default. Of course, we could make a latent variable unstandardized by fixing it to some other value, or (if there is enough information in the model) estimate its variance as a free parameter.

Moving Variables and Paths

It is easy to modify the appearance of a diagram by moving one or more variables. To select a variable, de-select everything by clicking on the selection tool ⁵ and then clicking on some open space in the diagram. Then click on the one variable, and drag it to its new position. To move several variables together, click on one of them, then press the shift key and click on another variable. Alternatively, you can click on the background of the diagram and drag a rectangle around the variables you wish to select. When all the variables to be moved are selected, you can drag them to their new location.

2.4 Extending the Model

Multiple Groups: Using Cut and Paste

A valuable feature of graphical interfaces is the ability to rapidly duplicate objects by means of cut and paste. Here we go through a simple multi-group example --- the classical twin study --- to illustrate these actions.

Fitting the ACE Genetic Model

Structural equation modeling of data from twins has been described in detail elsewhere. In summary, twin pairs are diagnosed as either Monozygotic (MZ) or Dizygotic (DZ). The pair is treated as a case, and the MZ pairs are analyzed in a separate group from the DZ. The structural equation model is configured with three latent variables which model possible effects of: additive genes (correlated 1.0 in MZ twins and .5 in DZ pairs); shared environment (correlated 1.0 in both types of twin pair); and individual-specific environment (uncorrelated between twins). This is a two-group example so we will draw two diagrams.

Drawing the MZ Diagram



To begin modeling, open the MX GUI and click on the open a new drawing icon . Then click the **DataMap** button and the **Open** button and select the file `ozbmi omz .dat` from the examples subdirectory. Select only the variable BMI-T1 and click **New** to drop it into the drawing. Move the data map window out of the way or close it, and start working on the drawing.

We need to add A1, C1 and E1 latent variables. Click on the latent variable icon  and draw three circles above the BMI-T1 variable. Relabel the variables to read A1, C1 and E1 by double clicking inside the circles and typing in the new text.

Next we need to add the causal paths from A1, C1, and E1 to BMI-T1. Click on the causal arrow icon  and click and drag from A1 to BMI-T1, and release. Do the same for C1 to BMI-T1 and E1 to BMI-T1. MX automatically labels arrows and variables for us, but we want to use specific names for our paths: *a*, *c* and *e*. Therefore, we double click on each path in turn and rename it in the label field of the Path Inspector. *Care is needed here!*

⁵ Clicking the right mouse button in a diagram offers an alternative, menu-driven way to change the drawing tool

Depending on the order in which the latent variables were drawn, there may already be a path called a , c or e on one of the latent variables. Relabelling the causal paths may have inadvertently caused an equality constraint that we don't want. Relabel any of the latent variable variance paths as necessary to make them different from a , c and e . Finally, because we are going to model individual-specific variation with e we can remove the variance path  on BMI-T1. Click inside it so that its blue select button appears and hit delete or ctrl-x.

We now have a model for Twin 1, and we need to replicate it for the Twin 2. Either press ctrl-a or go to the **Edit** menu and click **Select All**. Press ctrl-c for copy and ctrl-v for paste (or use the icons  and  or the **Edit** menu equivalents) and you have a new copy of the model for an individual. Use the mouse to drag it to the right of the existing model. You may have to resize the window to give yourself space for this. Alternatively, you can zoom out the drawing with the  button (see below).

A very important step comes next. We have *duplicated* the model for twin 1 --- both the A, C and E part *and the phenotype* BMI-T1. We do not want to model the covariance between BMI-T1 and BMI-T1. When we duplicated the model for twin 1, the new BMI-T1 box was black rather than blue. This is because it is *not mapped to data*. To map it, we select the variable BMI-T1 (and only this variable) in the diagram. Then hit **DataMap**, click on BMI-T2 in the variable list, and then **Map**. The variable in the diagram turns blue and the label is revised to say BMI-T2. MX now knows what data we are analyzing.

To complete the model for MZ twins, we need to do two things. First, change the labels of the latent variables causing BMI-T2 to A2, C2 and E2 by double clicking on the circles and typing in the new names. This step is for cosmetic purposes - MX will still fit the correct model even if the latent variables have incorrect names. Second, we must specify that the covariances between A1 and A2 and between C1 and C2 are fixed at one. Click on the covariance path tool . Click on A1, drag to A2 and release. Do the same for C1 and C2. Note that if you drag from right to left, the arrows curve downwards rather than upwards. The curvature can be adjusted by clicking on the arrow and dragging the blue selection button in the middle.

You must now fix the A1-A2 and C1-C2 covariances to one. Click on each path in turn, check the "Fix this parameter" box, make the starting value 1, and select "Display Starting Value". At this stage the diagram should look something like Figure 2.5. It would be possible to run this model, but the parameters a and c are confounded when we have only MZ twins. To identify the model we must add the DZ group.

Drawing the DZ Diagram

Adding the DZ twin group is easy. Click on the MZ diagram and hit ctrl-a (select all) and ctrl-c (copy). Then press the new drawing icon . Click on the new diagram, press ctrl-v (paste) and the MZ model is copied into the new drawing window. Two steps remain. First click on the covariance between A1 and A2 and change its starting value to .5 - the value specified by genetic theory. Second, map the observed variables to data. Hit the **DataMap** button and select the file `ozbmi odz.dat`. Highlight BMI-T1 and BMI-T2 in the variable list and click **AutoMap**. Because the variable labels in the `ozbmi odz.dat` file are the same as the variable labels in the `ozbmi omz.dat` file, the automap function maps the variables from

the list to the diagram correctly.

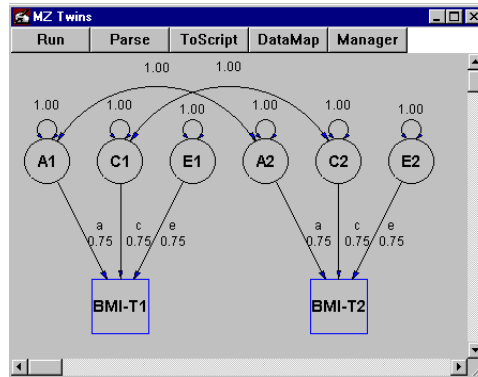

Figure 2.5 Starting values for an ACE twin model for MZ twins

Fitting the Model

Finally, run the model by clicking the **Run** button in either diagram. Enter `ace` as the filename for the script and diagrams. The Results Panel should report a fit of 2.3781 and the estimates in the diagram should look like those in Figure 2.6.

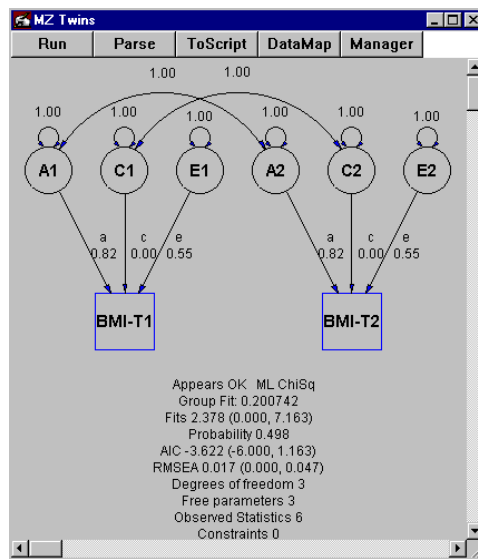

Figure 2.6 Parameter estimates from fitting the ACE model to MZ and DZ twin data

Note that in this example, there were two MX errors in the error window. These errors warn us that although we had supplied both means and covariances as data (in the `.dat` files), only a model for covariances was supplied. See below on page 22 for details on how to graphically model means.



Selecting Different Variables for Analysis

To unmap variables, you must select one and only one variable, go to the data map window, select only that variable in the list, and then press the **Unmap** button. You can then remap the variable in your diagram to another variable in the list by selecting the variable in the list and pressing **Map**.

The **AutoMap** feature lets you automatically map boxes to variables in a dataset by name. If you have a series of unmapped boxes in your diagram, and a series of unmapped variables in your dataset, then pressing **AutoMap** will map them by name. This is very useful when you have run an analysis on one dataset, then wish to fit the same model to a different dataset. It also comes in handy when you have multiple groups, with variables with the same names being analyzed in different groups, as we did with the twin study example above.

Modeling Means

The MX GUI allows the user to draw and fit models to means as well as to covariances. This is simplified with a new type of variable in a path diagram, the triangle. Let's add means to the twin model we developed earlier. If you do not still have the MZ and DZ drawings open, load them from the file `ace.mxd`.

Select the MZ diagram and click on the triangle tool . Point the mouse somewhere below the rectangles and click once to create a triangle. Then use the causal path tool  to draw paths *from* the triangle *to* the variables BMI-T1 and BMI-T2. Do the same thing in the DZ group. MX has automatically set new, free parameters on the paths and we can run the job.

The output for this job should give exactly the same goodness-of-fit to the model as we had before, because the model for the means is *saturated*. It has one free parameter for each mean. Let's test the hypothesis that Twin 1 means are equal to Twin 2 means. Go to the MZ diagram and make the label on the path from the triangle to BMI-T1 the same as the label from the triangle to BMI-T2. Do the same in the DZ diagram (keep the labels different from those on the paths from the triangles in the MZ diagram). Run the job again, and give it a new name, like `t1eqt2`. In the Project Manager window we see that the χ^2 (F:) has only slightly increased from 2.38 to 2.55 – an increase of less than .2 for two degrees of freedom, which is non-significant. This indicates that the hypothesis that the means of twin 1 and twin 2 are equal is not rejected.

To continue the example we can test whether MZ means are equal to DZ means. This is done by going back to the DZ diagram (`ctrl-tab` is a shortcut way to switch between MX windows) and changing the paths from the triangle so that they have the same label as those in the MZ group. Run the model again and call it `mzeqdz`. The χ^2 of 6.24 has increased by about 3.7 over the `t1eqt2` model, for one degree of freedom, which is not significant at the .05 level. The hypothesis that the MZ means equal the DZ means is not rejected. The sample sizes here (637 MZ and 380 DZ pairs) are quite large, so the chance that this result is a type II error (failure to detect a true effect) is small. The observed MZ-DZ mean difference must be small relative to the variance of body mass index in these data. We can

check this result in the Project Manager window. Select the t1eqt2 job and examine the predicted MZ and DZ mean in the ExpMean matrix for the MZ group and compare it with the ExpMean matrix in the DZ group by alternately selecting the MZ and DZ groups. The DZ mean is .45 and the MZ mean is .34 which is approximately .11 of a standard deviation different because the expected variance (see ExpCov) is about .97 for this model. The standard error of the difference between two means is given by the formula $\sqrt{SD_1^2/n_1 + SD_2^2/n_2}$. This formula isn't entirely appropriate for the case in hand because we have correlated observations making up the two samples. If we pretend that they are uncorrelated then the standard error would be approximately $\sqrt{1/760 + 1/1274} = .0458$. If we pretend that the twins are perfectly correlated then we would have $\sqrt{1/380 + 1/637} = .0648$. The first estimate of the standard error would give a z-score for the difference of $.11/.0458 = 2.40$ (significant at .05 level), whereas the second would give 1.70 (not significant at .05 level). The truth lies somewhere in between, and a very nice property of the maximum likelihood testing is that it handles these complications with ease and provides appropriate tests for both independent and correlated observations. The χ^2 difference test above showed that the difference was not quite significant at the .05 level. Better still, we can obtain confidence intervals on this χ^2 test and on the parameter estimate itself.

The MX Model for Means

When computing a predicted mean, MX traces the paths from an observed variable (rectangle) to a mean variable (triangle) and multiplies the paths together. If there are several triangles or pathways from a triangle to an observed variable, it sums their contributions to the mean. Note that, unlike covariances, there is no changing of direction when traversing paths, and only the single-headed arrows are used. The matrix formula MX uses to compute the predicted means (shown in ExpMean in the Project Manager) is

$$\text{ExpMean} = \mathbf{F}(\mathbf{I} - \mathbf{A})^{-1} \mathbf{M} \mathbf{U}$$

where \mathbf{U} is a unit matrix and \mathbf{M} contains the paths from the triangles to the circles and squares.

2.5 Output Options

Zooming in and out

To zoom into a part of a diagram, click on the zoom in tool  then click on the diagram workspace and drag a rectangle around the part of the figure that you wish to enlarge.

To zoom out, select the zoom out tool  click on the diagram and drag a square inside it. Note that this feature works proportionately, so that it is possible to get a very tiny and unreadable figure if you drag a very small square by mistake.

Sometimes zooming operations can cause a diagram to become so big or small that it disappears altogether. A click on the zoom undo button  will shrink or expand the diagram to roughly fit the window size.

Copying Matrices to the Clipboard

A matrix may be copied to the Windows clipboard by selecting it in the right hand panel of the Project Manager window, and pressing ctrl-c or the copy icon . The contents of the windows clipboard may then be pasted into wordprocessing or spreadsheet applications, usually by pressing ctrl-v or clicking the appropriate paste tool or menu item. By default, the matrices are copied with a tab character between each column, and a carriage return character at the end of each row --- suitable for many applications. These defaults may be changed using **Preference|Matrix Options**. For example, to obtain output formatted suitable for a LaTeX table, the user-defined delimiters should be changed to & for columns and \\ for rows. Note also that the number of decimal places may be changed. Diagrams may be copied to the clipboard as described below.

Comparing Models

When several models have been fitted to the same data, it is possible to generate a table of parameter estimates and goodness-of-fit statistics automatically. The menu item **Output|Job Compare** will build a file of comparisons, which you can view with a text editor. The first column of this file contains a list of all the paths in the model, followed by the fit statistics. The remaining columns are the estimates and fit statistics found for all the models in the project manager. This table may then be copied into other software for publication. The format of the table depends on the **Preference|Matrix Options** in the same way as copying matrices to the clipboard.

To get only a few of the models in the manager, simply delete the jobs that should be excluded from the comparison, by selecting them and hitting the Project Manager **Delete** button.

Setting Job Options

MX uses a default set of job options suitable for most general purpose model-fitting, but there may be times when other settings are desired. The Job Option panel (menu **Preference-Job Option**) is used to change these settings. Figure 2.7 shows the default settings.

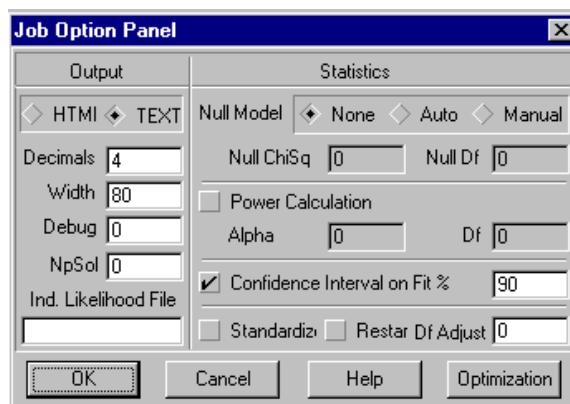



Figure 2.7 The Job Option Panel. Text output with four decimal places of precision and 80 column width will be generated. Debug statistics and individual pedigree likelihood statistics will not be generated. Confidence intervals (90%) on the fit statistics will be computed, and null model and power statistics will not. Parameter estimates will not be standardized. New MX jobs created from diagrams will be started from the starting values in the diagram, not the current estimates.

Text Output

Having run an MX job, you may wish to view the regular text output. If so, simply hit the output tool . The MX GUI comes with a shareware editor called `notebook.exe` which you can select. It allows you to edit and view much larger files than Microsoft Windows' Notepad editor. You can select an alternative text viewer via Preferences (though we do not recommend Microsoft Notepad because of its inability to edit large files).

HTML Output

Flexview is supplied with MX to simplify the viewing of HTML output. In order to use it, you must first tell MX to produce HTML output when it runs, before running the job. This you do via the **Preferences-Job Option** menu item. Netscape 4.5 could be chosen, but earlier versions start up slowly every time. Under Internet Explorer 4.0, choosing explorer as the html viewer (typically found in `c:\windows\explorer.exe`) works quite well. For large output files, Flexview does not work well and text output or another viewer should be used. Flexview is shareware and you should register it if you decide to use it regularly.

HTML and Text Appearance

You can change the number of decimal places and the width of MX output by entering different values in the decimals and width fields.

Debug Output

Auxiliary output about optimization may be printed to the file `nagdump.out` by requesting `NpSol` values greater than 0 (up to 30). Debug output will go to this file as well if Debug is set to 1. Debug prints the values of the parameter estimates and the fit function for each group for every iteration during optimization. Such files can be both large and slow to write to disk, so we recommend only using these features in an emergency.

Individual Likelihood Files

If you are using raw data, it is possible to save the individual likelihood statistics (see #p. 72) to a file by entering a filename in the text box "Ind. Likelihood File".

Additional Statistical Output

Certain 'comparative' fit indices require the computation of the fit of a Null model. By default the null model has free parameters for the variances and zero covariances. This model will be fitted automatically by MX and the statistics will be computed if the Null model radio button is set to Auto. Sometimes, a different null model than the default is required; this model should be fitted by the user and the χ^2 and degrees of freedom noted. These statistics would then be entered by first selecting the Manual radio button and then entering values in the Null ChiSq and Null Df fields. The additional statistics will be visible in the Results Panel.

Power Calculation

To compute statistical power, the “Power Calculation” checkbox should be checked, and the alpha-level and degrees of freedom should be entered. See the #p. 62 for information on how to fit models that assess statistical power.

Confidence Intervals on Fit

By default the MX GUI requests 90% confidence intervals on fit. If an alternative interval is required, it can be entered in this text field. If CI's are not required, then the check box can be cleared. Note that this is not the same as confidence intervals on the parameter estimates, which must be requested for paths using the Path Inspector.

Standardize

By default, MX produces unstandardized parameter estimates. This default may be changed by selecting the “Standardize” check box. The graphical interface then generates different MX scripts which include non-linear constraint groups to remove the variance of the variables. This box should be checked when working with correlation matrices to obtain correct confidence intervals on the parameters. Correlation matrices should be entered in dat files with a `KMatrix` not a `CMatrix` command.

Restart

The Restart check box changes the scripts generated from diagrams. Instead of using the starting values of paths, the current estimates are used instead. If a model has been fitted before, and is only slightly changed, e.g. by fixing one parameter, then re-running from the existing estimates may be much faster than starting from the starting values again.

Optimization Options

MX uses certain default values of the optimization parameters which have proven to be reliable under a variety of conditions. Occasionally it is necessary to use different settings; these technical options are described on p. 95. For the most part, these options should not be changed.

If optimization ends with the message “Possibly Failed” you can try to restart optimization automatically with Random Start at -2 for two attempts to solve the problem. If you want to try randomized starting values for a model, set it to a positive value, but be sure to put sensible boundaries on all your free parameters.

Printing

To print diagrams, click the printer icon  or use the **File** menu and select **Print**. Note that the part of the diagram visible in the window is printed. Print can also be used to print scripts from the editor window. The script font can be changed with the **Preferences|Script fonts** menu item.



Printed output can be previewed with the **File|Print preview** menu item or the preview tool  on the toolbar. This feature is a good way to save time and paper. Some features of printing, like printing the object handles on selected objects, may be unexpected, so print preview is recommended.

Improving Print Quality

There are various ways to improve the visual appearance of the diagrams. Generally, these are worth doing for final copy, such as printing for publication or to make slides for a talk.



First, you can move the path labels away from the paths by clicking on them and dragging them to a new location. Occasionally it may be difficult to select the label because another object, such as the path, is selected instead. If so, try clicking slightly to the right of the label. Second, in **Preferences** you can choose font size and appearance, separately for the paths and the variables. Also in **Preferences** you can choose line thickness, which currently affects both the paths and the lines around the variables. To add impact for color printing, you can change the color of the background and foreground components (paths, boxes, text etc.) in a diagram. Third, remember that the amount of information displayed about a path – labels, estimates, confidence intervals, boundaries and so on – can be changed for individual paths with the Path Inspector. Revising the appearance of many paths simultaneously can be done by selecting several paths and checking the “apply to all” box in the Path Inspector.

The variance arrows sometimes become obscured by paths going to and from variables. They may be dragged to one of eight positions around circles or squares.

Aligning Variables and Paths The grid tool  adds a grid to the currently active drawing. The color and size of this grid can be changed via the **Preferences|Grid** menu item. It is then simple to align circles and squares to this grid by moving them. Much faster is to use the snap to grid feature , which automatically aligns variables on the grid. Objects will move only to another grid place, so moving a variable a small distance often won't have any effect at all. Moving it a greater distance will allow it to snap to a new grid position. The granularity or size of the grid can be changed using **Preferences|Grid size**.

Paths labels are given a default central position based on the length and direction of the path they are labeling. If a path is longer in the vertical axis than the horizontal, its label will be centered vertically. Conversely, if it is longer in the horizontal axis its label will be centered horizontally. By moving objects further away it is sometimes possible to automatically align relevant path labels; this is the preferred way to align path labels. If necessary it is possible to move each individual label away from its default position by dragging it to a new position – but this should be used as a last resort. We recommend that print preview (**File-Print Preview** or ) be used to check the visual appearance of a figure.

Exporting Diagrams to other Applications

MX GUI uses the standard Windows clipboard to export diagrams to other applications. To export a diagram, left-click once on the background of the diagram, and then press ctrl-c or press the copy icon . This copies the figure to the clipboard. Open another application, such as Wordperfect, MS Word, Harvard Graphics or Visio and press ctrl-v (or select the paste menu command or click the paste icon ). Partial figures may be copied in the same way, by selecting only part of the diagram before pressing ctrl-c.

Diagrams may also be printed to a postscript file, if you have a postscript printer driver

installed. From the printer control menu, select encapsulated postscript as the postscript option, and check the 'Print to file' box.

Files and Filename Extensions

MX uses and creates a lot of different files, with specific filename extensions attached to them. To save disk space, some of them may be deleted. Table 2.2 lists the filenames and their contents, and indicates whether they may be safely deleted. Typically one does not want to delete data or useful drawing or script files. Malfunctioning scripts might be better deleted. At this time .prj files cannot be read back into the GUI.

Table 2.2 Summary of filename extensions used by MX

File extension	Contents	Delete
.dat	MX data	Probably not
.mx	Input script	Probably not
.mxd	MX path diagram	Probably not
.mxo	Text output	If no longer needed
.htm	Hypertext output	If no longer needed
.mxl	Frontend output	Yes
.prj	MX project	Probably not
.exe	Executable MX program	No
.dll	Dynamic link library	No

2.6 Running Jobs

Running Scripts

Many previous users of MX and those working with non-standard models (such as those involving constraints or special fit functions) will want to be able to run such models. The MX GUI has been designed to make working with scripts efficient. It lets you open script files, edit them, and view output in either the manager or text or hypertext (HTML) formats. In addition, if there are errors in the script, it will display them and with a click of a button will take you to the editor window with the problem text highlighted.

Let's take an example script. Start the GUI and click the open icon . Choose `twinpar.mx` and hit **Run** in the editor window. The MX statistical engine runs the job in the background and then delivers the output to the manager. We don't need to bother with the details of this particular job, it's just an example to show how several groups appear. You can easily look at the matrices in the different groups by selecting the group in the middle panel and the matrix in the right hand panel.

As we run more jobs, perhaps editing the script or selecting other scripts, the Project Manager fills up with the new jobs. The fit statistics from all jobs become visible in the bottom panel when the **Statistics** button is pressed.

Errors in Scripts

To help debugging of MX scripts, the line and column of the input file where an error occurred is automatically sent to the GUI to speed up debugging of scripts. Let's see how this works with an example.

Edit a dummy script by hitting the new icon . Type in the following:

```
Title  
Data Ngroups=1  
Oops a mistake  
Begin Matrices;
```

Hit **Run** and see what happens. Click the left mouse button on the error, and note how the editor window shows the Oops text highlighted. You are now in a good position to fix the problem, if you are familiar with the script language. A full description of the language is given in chapters 3-5 and examples are in chapter 6. Courses on MX are run quite regularly; consult <http://views.vcu.edu/mx>.

Sometimes it is helpful to look at the text or HTML output file to see full details of the error. Click the *right* mouse button on the error to bring up the output file. With HTML, the error is automatically presented, with Text output it is necessary to scroll to the end of the file.

Using Networked Unix Workstations

Performance and Multi-Platform Environments

The difference in performance between high-end MS windows computers and Unix workstations is narrowing all the time. Indeed, the same hardware can be used for either Unix or MS windows so it might be argued that it has disappeared. However, it is not very cost-effective to supply every student and faculty member with the latest and fastest PC. Many institutions still use a mixed platform computing facility in which there are powerful Unix servers available for general use, along with PC computers that have networked access to these servers. The Unix machines often have large amounts of memory, high-speed disk access and may offer much faster CPU than is available for PC's. To facilitate the use of these remote machines, MX GUI has a networking component which allows the user to select a remote Unix host to run MX scripts.

The Host Options Panel

Figure 2.8 shows the Host Options Panel set for local (on the PC on which MX GUI is running; left panel) and remote processing (right panel). By unchecking the local host checkbox, the user can enter the IP address of the Unix machine and their username and password. MX is not (yet) a standard part of the Unix operating system, so it must be installed on the host in question before remote access to it will work. The files and instructions for installation are available at <http://www.vipbg.vcu.edu/mxgui/unix.html>. As a user, you should make sure that your path on the Unix host includes the directory in which MX-Unix has been installed, which is usually `/usr/local/bin`.



Figure 2.8 Host Options Panel set for local PC use (left) and remote Unix use (right).

Running a Job Remotely

The following steps are required to run a job remotely:

- Make sure you have an account on a Unix host which has the MX server installed
- Go to the Host Options panel (**P**references-**H**ost Options menu) and enter the machine name, username and password
- Click Run in your diagram or script window
- Enter any commands to change directory⁶ on the remote host and click 'Execute'
- Click 'Run MX'
- Click 'Run MX' again if it says Possible Incompatible Remote Engine, Install New Remote Engine (this error often occurs spuriously)
- Wait for the job to run and to be transferred back to the GUI.

Transferring Files to Unix Hosts

Running MX GUI on a remote host has a few additional considerations. Foremost is the use of files, especially the `File=` subcommand used in MX scripts. Any file mentioned in a `File=` subcommand must be transferred to the remote Unix host (using e.g., ftp) in order for the Unix host to access it. For this reason, it is best not to put pathnames in the `File=` subcommands, because of inconsistencies between the Unix filenames system and the windows filenames system. It would become messy if the only place used for MX files was the root directory on the Unix host, so there are facilities for changing directory on the remote host prior to running scripts there. In the Host Command window, the user can enter a Unix command such as `cd mymxfiles` to change directory, before hitting the **Execute**.

One exception to the need to transfer files to the remote host is the `.dat` file specified in a diagram **DataMap** command. This file will be included in the script and automatically transferred to the Unix host. For this reason, it can be best to keep all the data in the `.dat` file itself and not to use the `File=` subcommand at all. In some circumstances this may be inefficient, especially if the network connection is slow, as all the data will be transferred with the job --- this applies especially to large raw data files or large asymptotic weight matrices. If several jobs are to be run using the same dataset, it may be more efficient to ftp these files to the Unix host and return to using `File=` in the script.

⁶ On Sun systems it may be necessary to change the shell with the command `ksh` to allow more than one job to be run per directory

Increasing Backend Memory

The default amount of memory available for the MX engine to store data, perform matrix algebra and optimization is 100,000 words for the PC version. This can be increased when necessary by changing the value in the Run Options panel (Figure 2.8). The Unix versions have a default of one million words of memory and at present this cannot be altered. If a larger Unix version is required, please email neale@vipbg.vcu.edu for a special build. Sometimes more efficient re-specification of a problem can free up workspace.

2.7 Advanced Features

In this section we consider some of the more advanced features of MX GUI, including adding non-linear constraints to diagrams, and the use of continuous moderator variables.

Adding Non-linear Constraints to Diagrams

In earlier sections we saw that it is straightforward to make one path equal another by giving it the same name. It is also simple to force the estimate of a path to lie within certain limits by double-clicking the path and entering boundary constraints. Much less simple is the addition of non-linear constraints which at this time can be done only by directly editing the script.

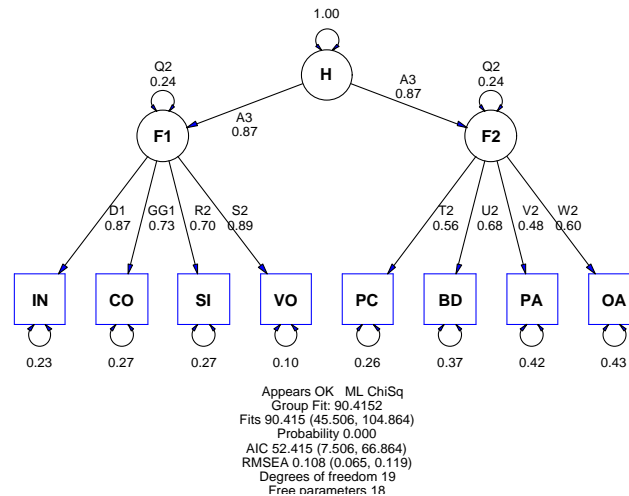

Figure 2.9 Higher Order Factor Model with nonlinear constraints imposed such that the variances of $F1$ and $F2$ are constrained to equal 1.0 ($.24 + .87^2 = 1.0$)

Figure 2.9 shows a diagram with a higher-order latent factor (H) and two first-order factors $F1$ and $F2$. Suppose that we wish to constrain the variance of the second-order factors to equal unity. One simple way to do this might be to eliminate H and allow the factors $F1$ and $F2$ to correlate, and give them error components fixed to unity. However, suppose that the paths from H were of substantive interest themselves, perhaps because of reports from other investigations. This example is for illustration, so we'll do it the hard way with non-linear constraints. The data come from Horn & McArdle (1992) and concern the sub-scales of the WAIS intelligence test, taken by subjects aged between 16 and 28 years of age. The tests

may be broadly categorized as verbal (IN: Information; CO: Comprehension; SI: Similarities; and VO: Vocabulary) or spatial (PC: Picture Completion; BD: Block Design; PA: Picture Arrangement; and OA: Object Arrangement).

The following steps are necessary:

1. Draw diagram
2. Build script from diagram (To Script)
3. Edit script file:
 - a. Increase NGroups by one to allow for new constraint group
 - b. Edit in the constraint group using MX script language
4. Run the job *from the script*
5. View parameter estimates in the diagram

The most difficult part of the sequence is of course 3(b), where knowledge of the MX script language and the way that the MX GUI creates scripts is required. We now give a brief description of the approach used to implement the constraints for this example.

Because the matrix expression for the covariances of all the variables (both latent and observed) is $(\mathbf{I}-\mathbf{A}^{-1}) * \mathbf{S} * (\mathbf{I}-\mathbf{A}^{-1})'$ we can compute this by equating matrices to those of the first group, and entering this matrix formula in a Algebra section. More tricky is to extract the relevant matrix elements corresponding to the variances of *F1* and *F2*. This can be achieved using the `\part(A,B)` function which partitions matrix A according to the rows and columns specified in B. Matrix B must have four elements and these identify two corners of the sub-matrix, so setting the elements of B to 9,9,10,10 will extract the 2x2 matrix from element 9,9 to element 10,10. We know that this is in fact the sub-matrix that we need by looking at the variable labels for matrix S in group 1. Variables *F1* and *F2* appear as the ninth and tenth elements of the list of labels. A second matrix algebra statement can be used to create the sub-matrix and place it in matrix T.

It remains to equate the diagonal elements of T to unity. This we can do using the `d2v` matrix function which extracts the diagonal of a matrix to a vector. It is then simple to request a constraint between this vector and a vector in which every element is 1.0, as shown in the following lines of MX script:

```
Title Add constraint to variances of F1 and F2
Constraint Ni=2
Begin Matrices = Group 1
  P Full 1 4 ! for the partitioning part
  U Unit 1 2 ! Two 1.0 elements to equate to variances
End Matrices
! deduce from labels for S above that F1 and F2 are variables 9 and 10
Matrix P 9 9 10 10 ! to be used for partitioning

Begin Algebra;
  R= (I-A)~&S; ! computes covariance of all variables, latent and observed
  T= \part(R,P);! computes the sub-matrix of R from element 9,9 to 10,10
End Algebra;
```

```
Constraint \d2v(T) = U ; ! constrains the diagonal elements to equal U
```

```
Option df=-1
```

```
! I add this df adjustment because really and truly all we have done
! is put the same constraint in twice, because the paths from H to F1 and
! from H to F2 are equal. A more efficient way would be to only constrain
! one of the variances (F1 or F2) but this is an illustration.
End
```

The constraint syntax above involves the = operator because we want an equality constraint. For nonlinear boundary constraints one could use the < or > symbols instead.

Once the script has been modified, care must be taken not to overwrite it with a new script from the diagram. If the diagram is modified, it is necessary to go through steps 2-4 again to run it, otherwise the constraint group will be lost. However, these steps are much easier the second time because cut and paste can be used to get the constraint group from the earlier script.

A final remark concerns the use of option df=-1. By default, MX will add one observed statistic for each non-linear constraint imposed. This addition of a statistic is analogous to the loss of a free parameter when two parameters are linearly constrained (equated) MX assumes that whatever non-linear constraints you are using effectively reduces the number of parameters (or equivalently increased the number of observed statistics) in the same way. In this example we did a silly thing, because both constraints were identical, so we really gained no information by adding the second constraint. The df=-1 option corrects this silliness.

Moderator Variables: Observed Variables as Paths

An interesting feature of MX is that it allows the specification of models that can differ for every subject in the sample. In some sense, this is the extreme case of multiple groups, and it has some interesting statistical possibilities. For one, this type of modeling is equivalent to Hierarchical Linear Modeling (HLM) as specified by Bryk and Raudenbush (1992) and others. This aspect of MX has not received much attention, but perhaps that will change now that the graphical interface facilitates the specification of some of these models.

We will illustrate the method with an uninspiring example of interaction terms in linear regression. This example has the advantage that we know the answer and can compare it with results from standard methods. The standard model of linear regression with interaction that we shall use is

$$y = b_1x_1 + b_2x_2 + \dots + b_3x_1x_2 + e$$

where b_3 is the interaction parameter of interest. In a path diagram, it is possible to model these data by pre-computing $x_1 \times x_2$ and fitting a model like the one shown in Figure 2.10. An alternative approach would be to allow two pathways from x_1 to y , one having the parameter b_1 , and the other going through two paths, one with the parameter b_3 and the other

having the individual's data for x_2 on it. Thus, by path analysis, the model for y would be equivalent to the model in the equation. The question is, how do we get individual-specific data onto the paths in an MX model?

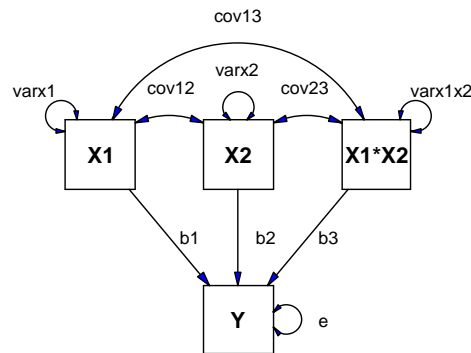



Figure 2.10 Linear Regression with Interaction Model with two independent variables, X_1 and X_2 and their product $X_1 \cdot X_2$ and one dependent variable Y .

Raw data is essential for fitting these ‘data-specific’ models. As described in the MX manual, two basic forms of raw data may be read by MX: variable length (‘VL’), and rectangular (‘Rect’). Rectangular is generally much easier to generate, and except for special cases such as many siblings in a family or very serious missingness it is easier to use. A .dat file with rectangular data might look like this:

```
!
! Rectangular data file created by Jane Datapro on Sept 31 1997
! using program /home/janedata/mxstuff/makemx.sas
!
Data NInput=4 NObservations=0
Labels X1 X2 X2d Y
Rectangular
1.234 2.345 2.345 3.456
4.321 3.210 3.210 2.109
...
End Rectangular
```

The ... indicate the remaining records of the dataset. Note the valuable comments at the start of the file - very useful for later retracing one's steps. The special feature of this data file is that the second variable (Mod) has been included twice (Mod2 is identical to Mod for all cases). We are going to make use of this variable twice - once as an independent variable, and once as a moderator variable. In a linear regression we normally remove the main effects of a variable before testing for the presence of interaction, hence the duplication.

Again we should remember that this simple example is for illustration, and that the same thing could be achieved more easily with standard software. The more complex possibilities that such modeling encompasses could not be easily specified.

Close any diagrams that you have open and start a new diagram , hit **DataMap** and open the `nonlin.dat` file from the examples directory. Highlight the $X1$, $X2$ and Y variables and click **New**. Then draw a covariance path between $X1$ and $X2$ and causal paths from these variables to Y . Then add a latent variable M by drawing a circle and draw paths from $X1$ to it and from it to Y . Select the path from the dummy variable to Y and then hit **DataMap** again. Highlight the remaining unmapped variable, $X2d$ and click **Map**. This variable has now been mapped to the *path* from M to Y . The path should be the mapped variable color (blue by default) and there should be a diamond surrounding the path label to indicate that it is mapped to a variable. The total effect from $X1$ to Y now contains both the linear and the interaction terms. Finally add means to the model; for raw data we must always have a model for the means. In the end your figure should look something like (topologically equivalent to) Figure 2.11.

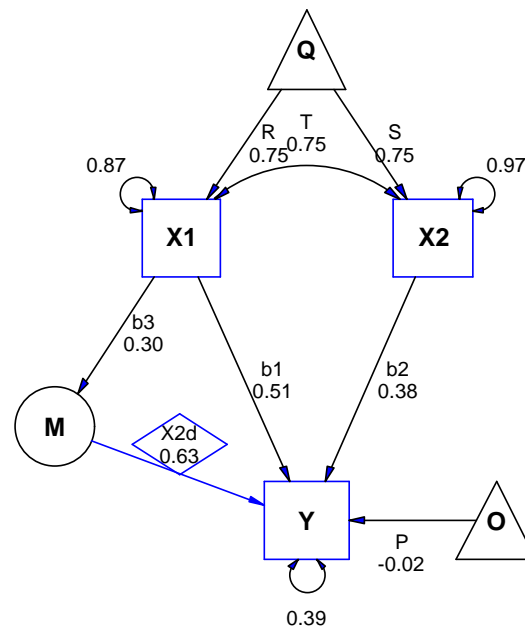

Figure 2.11 Linear Regression with Interaction; a moderated regression approach. Variables $X1$ and $X1d$ are identical in the dataset. Each individual has a different model because they have different values of $X1d$.

Run the model and be patient; fitting models of this type is computationally intensive. One special thing to note about the printed output and the results on the diagram is that the value on the $X2d$ path is that of the *last* case in the file. The results should closely approximate the values used for simulation, namely $b_1=.5$; $b_2=.4$; $b_3=.3$; and $e=.36$ More interesting

models would involve moderation of the effects of latent variables, and they may be specified in exactly the same way.

3 Outline of Mx Scripts and Data Input

What you will find in this chapter

- General rules for job structure and syntax
- Details on how to read data and select variables for analysis

3.1 Preparing Input Scripts

Comments, Commands and Numeric Input

Input files should be prepared with the text editor of your choice. If you use a wordprocessor (such as Word Perfect or MS Word) the input file should be saved in DOS text (ASCII) format.

You may put comments anywhere in your input file using the character '!'. The MX command processor ignores:

- All characters following ! on any line
- Blank lines
- Anything after column 1200

Lines in MX scripts may be up to 1200 characters long on most systems; the IBM RS6000 compiler has an upper limit of 500 characters, which is the limit for the AIX version.

The processor is also entirely insensitive to case, except for filenames under UNIX. Essentially, MX reads two things: *keywords* and *numbers*. Unless explicitly stated otherwise, the first two letters of a keyword are sufficient to identify it. Keywords are separated by one or more blank spaces. Once the program has identified a keyword you can extend it to anything you like *as long as it doesn't have a blank character in it*, so Data and Data_silly_words_ have the same effect.

Quite often, a keyword has the format KEY=123 where 123 is a numeric value to be input. This is called a *parameter*. MX ignores all (*including blanks*) non-numeric characters found between recognition of a parameter and reading a number, so that NI=100 and NInput_vars a lot of words 100 have the same effect.



Note: The exception to this rule is when it encounters a #define'd variable, which it will accept instead of a number.

Syntax Conventions

The syntax described for commands follows these conventions:

- alternatives are represented by /
- optional parameters or keywords are enclosed by { and }
- items to be substituted according to the specific application are enclosed by < and >

Job Structure

MX has been written for multiple groups, since genetically informative data generally comprise information on different types of relatives which form distinct groups. At the beginning of an MX script, you have to say how many groups there are with a #Ngroup statement. A group begins with a title line that contains from 1 to 1200 characters⁷ for reference. The second line is the Group-type line, and the group ends with an Output line. What happens in between varies according to what *type* of group it is. Currently there are 3 types:

- DATA - containing data to be analyzed
- CALCULATION - allowing matrix operations for output or to simplify structure
- CONSTRAINT - for non-linear equality and inequality constraints between parameters

Any number of each type of group can be specified, in any order. Unless one of the keywords Constraint or Calculation appears on the data line, MX expects to read a Data group. Effectively, there are 3 things to do:

- Supply the data
- Describe the model
- Request options

To do this, the input script will consist of groups, each having the following structure:

1. TITLE
2. DATA: indicate group type: data/calculation/constraint
3. Read and select any observed data, supply labels
4. MATRICES: declare at least one matrix
5. Specify numbers and parameters, starting values, equality constraints
6. MODEL: define matrix formula: covariance/means/threshold/compute
7. Request fit functions, statistical output and optimization options, multiple fit mode, save matrices and job specification
8. END command

Steps 1-3 supply data and are described in Section 3.1-3.5, steps 4-6 define the model (Section 4.1-4.6), and steps 7-8 requests output (Section 5.1-5.4). Constraint and calculation groups do not read any data, so they omit step 3.

⁷Or only 500 on the IBM AIX operating system

Single Group Example

For example, an input file may look like this:

```
#Ngroups 1
Simple MX example file
Data NObservations=150 NInput_variables=2
CMatrix 1.2 .8 1.3
Begin Matrices;
  A Full 2 1
  D Diag 2 2
End Matrices;
Specification A
  1 2
Specification D
  0 3
Start .5 all
Covariance_model A*A' + D /
Options RSiduals
End
```

This would fit, by maximum likelihood (the default) a factor model to a covariance matrix calculated from 150 observations of two variables. The model is shown as a path diagram in Figure 3.1. Details of this example will be found in the following sections.

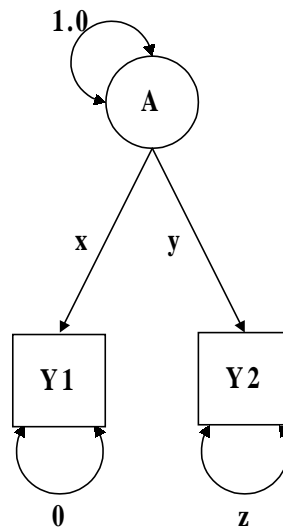

Figure 3.1 Factor model for two variables. Free parameters are indicated by x , y and z . Causal paths are shown as single headed arrows and correlational paths are shown as double-headed arrows.

#Define Command

Syntax:

```
#define <name> <number>
```

Various commands and keywords used in MX scripts search for a number. During this search, if MX encounters a letter it will read the word and check the dictionary for matching #define'd words. If the word is found, the appropriate number is substituted. If it hasn't, a warning will be printed and the search for a number or a #define'd variable will continue. Care is needed with spelling!

In multivariate modeling it is quite common that the same matrix dimensions are used in many different parts of a script. For example, in an oblique factor analysis, with 10 observed variables and 2 factors, the dimensions of the matrices needed to define the model are dictated by these numbers. If matrix **L** contains the loadings, **P** the correlations between the loadings, and matrix **E** the residuals, we would require **L** to be of order 10×2 , **P** to be 2×2 and **E** to be of order 10×10 . We might specify this in MX with a script of the form

```
Title - factor analysis
Data NInput=10 NObservations=100
CMatrix File=mydata.cov
Matrices
  A Full 10 2 Free
  P Stan 2 2 Free
  E Diag 10 10 Free
Covariance A*P*A' + E /
Start .5 all
End
```

However, this script could be made more general with a couple of #define statements:

```
#define factors 2
#define vars 10
Title - factor analysis
Data NInput=vars NObservations=100
CMatrix File=mydata.cov
Matrices
  A Full vars factors Free
  P Stan factors factors Free
  E Diag vars vars Free
Covariance A*P*A' + E /
Start .5 all
End
```

Gain is small in this simple model - we change two numbers to change the number of factors and number of observed variables, instead of seven. With more complex models, the use of #define can make scripts much simpler and more versatile.

Matrices Declaration

Syntax:

```
Begin Matrices; or Matrices= {Group <n>}
<matrix name> <type> <r> <c> {Free/ Unique}
...
End Matrices;
```

Matrices must be declared *after* reading any data for the group, and *before* assigning values or parameters to matrix elements. All declared matrices initially have zero for each 'modifiable' element. By default, all matrix elements are fixed. If the keyword `Free` appears, each modifiable element has a free parameter specified, starting at the highest parameter number yet specified below 10,000. If the keyword `Unique` is present parameters are numbered from 10,000 onwards. `Unique` helps to keep parameters from accidentally being constrained with subsequent `specify` statements. See page ? for more details on declaring matrices.

Matrix Algebra

Syntax:

```
Begin Algebra;
<matrix name> = {funct} <matrix name> {operator <matrix name> };
...
End Algebra;
```

Algebra sections provide a simple way to evaluate matrix algebra expressions, as shown in Appendix C.

In many cases breaking up a complicated matrix algebra expression into smaller parts can improve readability or efficiency or both. For example, the matrix formula $(\mathbf{I}-\mathbf{A})^{-1} * \mathbf{S} * (\mathbf{I}-\mathbf{A})^{-1}$ will find the inverse of twice. When matrix **A** is small the loss of efficiency will be negligible - the extra time taken to re-program will be greater than any gained in execution time. For large **A**, the component $(\mathbf{I}-\mathbf{A})^{-1}$ can be computed as an intermediate step so that the cpu-intensive matrix inversion is only carried out once and we have a compact and readable script. Algebra may be thought of as a special form of matrix declaration. Each matrix that appears on the left hand side of the = sign is newly defined in this group (it must not have been previously defined). Note that matrix **B**, defined in the first line of algebra, may be used in subsequent lines.

```
Begin Matrices;
A Full 10 10
S Symm 10 10
I Iden 10 10
End Matrices;
Begin Algebra;
B = (I-A)^-1 ;
C = B*S*B' ;
End Algebra;
```

3.2 Group Types

Every group has to begin with a Title line and a Group-type command. In a data group, these statements may be followed by reading of data. These commands are described in this section.

Title Line

The title line is purely for the user's reference, it is printed when MX prints the parameter specifications and the parameter estimates for a group. It is most useful when there are multiple groups. The title line is recognized by its location (the beginning of a group) rather than by a keyword at the start of a line.

Group-type Line

Syntax:

Data/Calculation/Constraint {NGroups=n NInput_vars=n NObservations=n}

where Calculation defines a calculation group and Constraint a constraint group, the default being a Data group

Every group must have a data line. It has a number of parameters to indicate

- i. what kind of group is being input
- ii. if it is the first group, NGroups, the number of groups, and
- iii. various characteristics (the number of input variables NInput_vars and the number of observations NObservations) of the data to be analyzed, if any.

The parameters may be specified in any order, and are summarized in Table 3.2. Note that Data groups must have NInput_vars and NObservations keywords. Constraint groups only require NInput_vars, and Calculation groups need no parameters except NGroups if it is the first group.

Table 3.2 Parameters of the group-type line in MX input files.

Parameter	Function	Required for group(s)
Data	Specifies a data group	Data
Calculation	Specifies a calculation group	Calculation
Constraint	Specifies a constraint group	Constraint
NGroups	Number of groups	First group
NInput_vars	Number of input variables	Data, constraint
NObservations	Number of observations	Data
Nmodel	Number of models	Weighted likelihood*

* required for fitting mixture models only, see section 4.3 on page 70

3.3 Commands for Reading Data

Covariance and Correlation Matrices

Syntax:

CMatrix/KMatrix/PMatrix {Full} {File=filename}

In a data group, a covariance matrix may be read using the keyword `CMatrix`. By default, `CMatrix` expects to read *the lower triangle* of an `NInput_vars` x `NInput_vars` matrix, from the input file. If the keyword `Full` appears, then a full matrix will be read. The matrix is read in free format, that is, the numbers are expected to be separated by one or more blank spaces or carriage returns. If the keyword `File` appears, then MX will read the data from a file. This latter method is generally to be preferred, since it keeps the data in one place. If the data are changed, it is not necessary to change every script that uses these data.

A FORTRAN format [in parentheses, e.g., (6F10.5)] for reading data must be the first line of a data file. If the first line just has * or (*) on it, the data are read in *free format*, i.e. numbers are separated by one or more spaces or new line characters.



Correlation matrices (`KMatrix`) and matrices of polychoric or polyserial correlations (`PMatrix`) are read in the same way as covariance matrices (`CMatrix`). Although the diagonal elements of these matrices are all 1.0, and could in principle be omitted, they are needed for MX to read the file correctly. See page 120 for an example of special methods required for maximum likelihood analysis of correlation matrices.

Asymptotic Variances and Covariances

Syntax:

ACov/AVar/AInv {File=filename}

In order to use asymptotic weighted least squares or diagonally weighted least squares (see p. 79) it is necessary to read a weight matrix. For compatibility with PRELIS (Jöreskog & Sörbom, 1986; 1993), MX expects to receive a weight matrix multiplied by the number of observations. If the `File=` option is used, a PRELIS output file (created with the `SA=filename` or the `SV=filename` PRELIS commands) may be read. By default, MX expects to receive an asymptotic weight matrix (`ACov`) whose size depends on (i) `NInput_vars` and (ii) whether a correlation matrix or covariance matrix has been input. If `NInput_vars=k`, then if `CMatrix` has been input, the number of rows in `ACov` is

$$p = k(k+1)/2$$

or if `PMatrix` or `KMatrix` have been input, the number of rows in `ACov` is

$$q = k(k-1)/2.$$

The weight matrices can thus be very large - of order

$$p(p+1)/2 \text{ or } q(q+1)/2$$

If you use PRELIS, please be sure to use PRELIS 2 instead of PRELIS 1, as the off-diagonal elements of the asymptotic weight matrices produced by PRELIS 1 appear quite inaccurate at the time of writing (PRELIS 1.20 and earlier). Later versions of PRELIS output the file in binary format, which must be changed with the `bintoasc.exe` or `bintoggl.exe` utility supplied with PRELIS.

An `ACov` line makes AWLS the default method of estimation for that group. If AWLS is requested on the `Options` line in a group without an `ACov`, and error will result. Similarly, DWLS is default if `AVar` is read.



Note that inverting the asymptotic covariance matrix can take an appreciable amount of time for large problems. Two facilities are available to combat this problem. First, the inverse of the matrix can be read instead. A simple MX job could be used to invert and save the inverse, for example:

```
Commands to invert a 325x325 asymptotic weight matrix
Data Calculate NGroups=1
Matrices
  P Symm 325 325
Compute P~ /
Matrix P File=weight.asy
Output MX%E=weight.inv
```

The inverse of the asymptotic matrix (`AInv`), saved in the file `weight.inv` could be used in place of the matrix itself, with a command of the form: `AInv Full File=weight.inv`. The `Full` keyword is essential here because MX is agnostic about the symmetry of square matrices created in calculation groups. It is safer to assume that it is not symmetric to maintain consistency across applications. The second, alternative approach is to use the binary save feature described on page 99, which saves the whole job specifications.

A common error in reading data with `CMatrix` or `ACov` commands is to read them as full matrices when they are stored as symmetric, or vice versa. MX attempts to be a bit smarter about this process. If a user forgets to put the `Full` keyword on the `CMatrix` line, but MX detects an MX-style data file that was saved in full format, it will read it as full instead.

Variable Length, Rectangular and Ordinal Files

Syntax:

```
VLength/Rectangular/Ordinal {File=filename} {Highest <numlist>}
```

MX will read two types of raw data for multivariate normal maximum likelihood analysis. Rectangular reads *regular* data, i.e. where every observation has the same number of input variables (`NInput_vars` on the `Data` line). Missing values may be specified with a `.` (dot) or another code (see `Missing` command on page 46). This is appropriate if there are relatively few missing data, or if missing data have been imputed.

VLength is a variable length record reader, which allows reading of raw data where there may be many missing values. The default (and mandatory) format for these data is *free*. A line with comments or * can be placed at the start of the file, but it will be ignored by MX except for printing a warning and the line itself in the output file. The structure of a VLength file is:

- number of input variables (k)
- identification codes for the k variables
- observed data for the k variables.

For every case, the number of input variables must be on a line by itself. The identification codes must be integers that correspond to codes read by the ICodes command (see page 77). For example, a file might contain the following:

```
3
1 2 3 .33 .62 .95
2
2 3 1.4 -2.2
1
2 .37
```

This example reads 3 variables for the first observation, with identification codes 1 2 3, and data values .33 .62 and .95. The second observation has no data for variable 1, but supplies data for 2 and 3, while the third supplies data for variable 2 alone. By default, data of this type are fitted using the raw maximum likelihood fit function (see page 82).

It is quite simple to prepare VLength files with SAS or SPSS. However, caution should be exercised with SAS which uses a . for a missing value. Depending on the operating system under which you are running MX, this dot may produce a file read error or be read as a zero. Here are a few lines of SAS code to output a VLength file from an array of two variables $V\{2\}$, either or both of which may be missing. The third and fourth lines need to be modified to declare the length of the array and to copy the required variables to the array into it. Certain applications may also need to change the format of the PUT statement that writes the data values.

```
DATA ONE; SET ZERO;
COUNT=0; NVAR=2;          /* Number of variables in total !!Change!! */
ARRAY V{2} AT1 AT2;       /* Set up array for variables !!Change!! */
DO I=1 TO NVAR;           /* Count the non-missing observations */
IF V{I} NE . THEN DO; COUNT+1; END; END;
FILE MXVLFIL;            /* Filename for future Mx input !!Change!! */
IF COUNT NE 0 THEN DO;   /* Write observations if there are any */
PUT COUNT;
DO I=1 TO NVAR;
IF V{I} NE . THEN PUT I @@;          /* Write the identifiers */
END; PUT;
DO I=1 TO NVAR;
IF V{I} NE . THEN PUT V{I} 13.6 +1 @@; /* Write the data values */
END; PUT;
END;
```

Note: format statements are not valid for either rectangular or VL files.

Similar to the rectangular command to read raw continuous data, the `Ordinal` file statement reads in ordinal data from a rectangular file. By default, a . (dot) character separated by spaces is recognized as a missing value, and this default may be changed by inserting a `Missing` command *before* the `Ordinal` statement. Ordinal data must be specified by integer categories, with the lowest category zero. The highest category in the ordinal data is automatically detected by MX, but in some cases, especially multigroup analyses, it is necessary to override this default with a user specified value. The largest value in the data file must not exceed the corresponding value in the highest statement.

Missing Command

Syntax:
`Missing=<code>`

The missing command may be used to supply a character string other than . (dot) to be used for missing values, e.g. `Missing=N/A`. Note that MX responds to the *exact character string*, and *not* the numerical value of that string. For example, if `Missing=-1.0` has been specified, then neither -1 nor -1.00 would be recognized as missing.

Definition Variables

Syntax:
`Definition_variable <label>`
`...`
`Specification <matrix name> {element list} label {element list}`

This feature allows ‘multilevel’ statistical analyses with VL or rectangular data files. Essentially, some variables may be assigned as definition variables which can then be used in constructing the model. Definition variables are automatically `#define`’d so that their names can be used in `Specify` statements. A matrix containing a definition variable *changes for every case in the raw data file*. See page 133 for an example that allows continuous moderators - effectively as many groups as there are cases in the data file. Labels should be provided for all variables before using the definition statement.

Contingency Tables

Syntax:
`CTable <r> <c> {File=filename}`

MX will read contingency tables of order r by c . `NInput_vars` must be 2 for a group reading a contingency table. Both r and c must be greater than 1 but they do not have to be equal. A contingency table contains frequency data (or counts) such that each cell C_{ij} indicates the number of observations falling in row category i and column category j . Normally, the frequencies supplied should be greater than or equal to zero.



If frequency data are read directly into the script, they need to start on a new line, following the `CTable <r> <c>` line.

MX automatically handles incomplete ascertainment which the user can flag by supplying a negative number for cells that have not been ascertained (see example on p. 86). Instead of modeling means, the placement of thresholds on the underlying liability distribution is specified with the threshold statement, as shown on page 69.

The ordering of the categories should follow the natural numbering of the rows and columns, so that a table with a strong positive correlation between the variables would have large frequencies on the leading diagonal. Supplying a `CTable` changes the default fit function to the likelihood of observing the frequencies assuming a bivariate normal distribution of liability underlies the observed presence in a cell. See page 85 for details on fitting structural equation models to contingency table data.

Means

Syntax:
`Means {File=filename}`

A vector of means, length `NInput_vars` may be read. When fitting models by maximum likelihood, a matrix formula for the predicted means may be provided. The joint likelihood of the means and the covariances is maximized, enabling tests of hypotheses about equality of means across variables or across groups.

Higher Moment Matrices

Syntax:
`Skewness/Kurtosis {File=filename}`

Matrices of skewness and kurtosis may be read with these commands. These are provided for future developments in MX that will allow model fitting to these types of data in addition to means and covariances. Currently there is no facility to use matrices read in this way. However, model fitting with higher moments could be done with user-defined fit functions (see page 86).

3.4 Label and Select Variables

Labeling Input Variables

Syntax:
`Labels <list of labels>`

Labels may be given for the observed data by issuing a `Label` command, before the `Matrices` command. These labels may be used to select variables, for example:

```
Data NGroups=1 NInput_vars=3 NObservations=171
CMatrix File=Cov.mat
Labels ALC1 ALC2 AGE
Select ALC2 ALC1 /
```

would read the lower triangle of a 3×3 covariance matrix from the file `Cov.mat`, and label the variables `ALC1`, `ALC2` and `AGE`. The variables `ALC2` and `ALC1` are then selected for analysis, changing their original order. See also page 76 for details on labeling specified matrices.

Select Variables

Syntax:

```
Select <numlist or varlist> /
```

Variables may be selected for analysis using the `Select` command. The command may be used to reorder data or to pick a reduced number of variables for analysis. In either case, *a ; or / must end the command*. `Select` accepts *integers* which correspond to the order of the input variable. More conveniently, `Select` will operate on variable labels (see page 47). The command will work with raw data as supplied by the `Rawdata` or `VLength` commands (see pages 82 and 44).

Select If

Syntax:

```
Select If <label> {< = > ^< ^= ^>} value/
where ^ denotes not.
```

`Select If` may be used in conjunction with raw data (`VL` or `Rectangular`) to select a subset of the data for analysis. This feature is useful to eliminate outliers from a raw dataset, if a case number or id variable has been included. For example,

```
Rectangular File=mydata.rec
Labels casenum BMI skinfold1 skinfold2;
Select If casenum ^=253;
Select BMI skinfold1;
```

might be used to eliminate all cases where casenum is 253.

Select with Variable Length Data

In combination with the `VL` or `rectangular` data, `select` changes the identification codes to consecutive integers starting at 1. For example, if the following `Select` line was read:

```
Select 3 4 2 /
```

a `VLength` record of the form:

```
4
1 2 3 4 .1 .2 .3 .4
```

would be changed to:

```
3
1 2 3 .3 .4 .2
```

thus the observation originally numbered 3 has become observation 1, observation numbered 4 has become observation 2, and observation numbered 2 has become observation 3. `Select` will automatically reduce the number of data vectors if there are no matches for a particular data vector and the codes in the `Select` line. The final number of vectors and observations used in the analysis is given in the output file.

`Select` cannot contain more numbers than the `NInput_vars` specified on the `Data` line. To do so would necessarily result in a singular correlation or covariance matrix. Likewise, the same variable cannot be selected twice.

3.5 Calculation and Constraint Groups

The use of calculation and constraint groups is very similar the use of groups that read data. All three types of group are fully command compatible with the exception of commands for reading data, which can be used by data groups alone.

Calculation Groups

The keyword `Calc` on the `Group-type` line indicates that the group is used for calculation. The calculated matrix formula from such a group is printed if the `RSiduals` command appears on the `Options` line. There are no restrictions on the type and dimensions of a matrix than can be produced with this command (other than memory limits). The result of the calculation may be used in later groups by using the `=%En` syntax when specifying a matrix, where n is the number of the calculation group. Note that there is a strict ordering within the input file; results cannot be taken from a calculation that has not yet occurred.



The `Calc` group provides a facility for printing out results of matrix operations. Any calculation group that is not followed by a constraint or data group is not calculated until the end of optimization, thus avoiding unnecessary waste of computer time.

Constraint Groups

Constraint groups may be used to impose nonlinear equality or inequality constraints among the parameters. Three special operators may be used to impose constraints between matrices. For example, suppose we wish to impose the constraint that $x^2+y^2=1$ where x has parameter specification 1 and y has parameter specification 2. A constraint group to accomplish this might be:

```
Constrain parameters to ensure that x*x+y*y=1
Constraint_group
Begin Matrices;
  A Full 2 1
  I Iden 1 1
End Matrices;
Specify A 1 2 ! Put parameters 1 and 2 in to A
Constraint A'*A=I; !Inner product works out x*x+y*y
End Group;
```

If we wanted to impose the inequality constraint that $x^2+y^2 > 1$ instead, then we would use the $>$ symbol in the Constraint statement. Likewise, we could use $<$ to specify a less than inequality. Only one $<$, $>$ or $=$ symbol may be used in a constraint statement. To specify range constraints such as $.5 < x^2+y^2 < 1$ it is possible to specify both constraints within the same constraint statement by concatenating them as two inequality constraints:

Constrain parameters to ensure that $.5 < x*x+y*y < 1$

```
Constraint_group
```

```
Begin Matrices;
```

```
  A Full 2 1
```

```
  I Iden 1 1
```

```
  H Full 1 1
```

```
End Matrices;
```

```
Matrix H .5
```

```
Specify A 1 2 ! put parameters 1 and 2 into A
```

```
Constraint (A'*A_
```

```
  H) < (I_
```

```
  A'*A); ! Inner product works out x*x+y*y
```

```
End Group;
```

Note that the constraints are made element by element. Using option RS we can see the results of imposing equality or inequality constraints.

Whenever MX encounters a constraint group, it increases the number of degrees of freedom by the number of nonlinear constraints. This increase in the number of statistics is based on the assumption that each constraint identifies a parameter, which may not always be correct. The DF parameter on the Options line (see page 89) may be used to correct for failures of this assumption.

NPSOL, the optimization routine, treats constraints in an intelligent fashion; if it finds the derivatives of the constraint functions with respect to certain parameters to be zero, it does not calculate them during optimization. This means that if some of the specified constraint functions are always zero, little additional computational cost is incurred.

!!

Care is needed to make sure that the constraints can be satisfied. If there is no feasible point for the constraints - for example, one of them always takes the value .5 - an IFAIL=3 error message is returned. One way to avoid such errors is to start optimization at a place where the constraints are satisfied.

4 Building Models with Matrices

What you will find in this chapter

- How to declare matrices and label them
- The structure of the different types of matrix
- What the matrix operators and functions do
- When and where to use matrix formulae
- The role of different types of group

All groups, be they constraint, calculation, or data, require at least one matrix in order to do anything. The next few sections describe the types of matrix that may be used, the operators that act on and between them, and ways of putting parameters and numbers into them.

4.1 Commands for Declaring Matrices

Matrices Command

Syntax:

```
Begin Matrices {= Group <n>};
<matrix name> <type> <rows> <columns> {= <name> <group> / Free, Unique}
...
<matrix name> <type> <rows> <columns> {= <name> <group> / Free, Unique}
End Matrices;
where n is a previous group number
```

A group must have the *3-letter* MAT command, followed by at least one matrix definition. As used throughout this manual, we recommend using non-abbreviated commands, such as Matrices.

Matrix names are restricted to one letter, from A to Z. The same letter may be used for different matrices in different groups. If a matrix is declared twice, a warning is printed and only the second declaration is kept.



Note that matrix definitions are *group specific*; for example, matrix **A** in group 1 does not have to be the same type or size as matrix **A** in group 2.

If the keyword = follows the Begin Matrices command, all matrices in that earlier group are automatically declared in the present group.

Matrix Types

The type of a matrix may be one of the 12 forms described in Table 4.1, and its row and column dimensions are specified with integers. Once the type and size of a matrix has been defined, it cannot be changed.

Table 4.1 Matrix types that may be specified in MX.

Type	Structure	Shape	Number of Free Elements
Zero	Every element is zero (null matrix)	Any	0
Unit	Every element is one (unit matrix)	Any	0
Iden	Identity matrix	Square	0
IZero	Identity Zero partitioned matrix	Any	0
ZIden	Zero Identity partitioned matrix	Any	0
Diag	Diagonal matrix	Square	r
SDiag	Subdiagonal (zeros on & above diagonal)	Square	$r(r-1)/2$
Stand	Standardized (symmetric, ones on diagonal)	Square	$r(r-1)/2$
Symm	Symmetric	Square	$r(r+1)/2$
Lower	Lower triangular	Square	$r(r+1)/2$
Full	Full	Any	$r \times c$
Computed	Equated to formula in previous group	Any	0

Note: number of free elements indicates the number of elements that can be altered by the user, where r is the number of rows and c the number of columns of the matrix.

Equating Matrices across Groups

Syntax:

<matrix name> <type> <r> <c> = <matrix name> <group number>

or

<matrix name> <type> <r> <c> = <special quantity> <group number>

Optionally, a matrix may be constrained to equal a matrix *previously* specified. For example, we could use the command

A Symm 3 3 = Y2

to equate matrix **A** in this group to matrix **Y** in group 2. In this example the current group must be number 3 or greater.

Several additional options allow constraints to other quantities found in previous groups, such as the observed or expected covariance matrix. For example, the command

B Full 2 2 = %E1

equates matrix **B** in this group to the expected matrix of group 1.

The special codes for constraining a matrix to equal those defined or computed in previous groups are shown in Table 4.2. These add to the flexibility of MX.

Table 4.2 Syntax for constraining matrices to special quantities in previous groups.

Symbol	Matrix Quantity	Dimensions
%On	Observed covariance (data) matrix	$NI_n \times NI_n$
%En	Expected covariance matrix	$NI_n \times NI_n$
%Mn	Expected mean vector	$1 \times NI_n$
%Pn	Expected proportions under bivariate normal	$NR_n \times NC_n$
%Fn	Function value	1×1

Note: NI_n is the number of input variables in group n following any selection; NR and NC are respectively the number of rows and columns in a contingency table, and may be requested only if group n has such a table.

It is especially important to note that *none of the %E, %O, %M, %F and %P equalities may refer to groups that appear after the current group*. When matrices are constrained to be equal in this fashion, the type and row \times column dimensions of the earlier matrix are retained. If the two specifications do not agree, a warning is printed. Both the number of rows and the number of columns must be supplied for square matrices, but only the first is used to define the size of the matrix.

Equating Matrices to Computed Matrices

Syntax:

<matrix name> computed {<r> <c>} = <matrix name> <group number>

When matrices are declared with the `Matrices` command, a special type, `computed`, may be used to equate to a matrix which was defined within the algebra section of a previous group. Row and column dimensions are set to those of the previously calculated matrix, and may be omitted when declaring a matrix as computed.

Equating All Matrices across Groups

Syntax:

Begin Matrices = Group <number>;

The usual equating of matrices across groups is supplemented by a global facility. All the matrices defined in an earlier group are made available to the current group. This includes both matrices that are explicitly declared and those that are created in a `Begin Algebra; ...End Algebra;` section.

Free Keyword

All changeable elements of matrices are initialized at zero and are fixed parameters, unless the `Free` keyword is used, in which case each changeable element is specified as a different free parameter. Examples of the results of using the keyword `Free` are shown in Table 4.3.

Table 4.3 Examples of use of the `Matrices` command to specify the dimensions of different matrix types. The keyword `Free` following each command makes each modifiable element in the matrix a separate free parameter, numbered in order as shown in the second column. In the third column, values of elements are shown, with `?` representing a free parameter.

Example command	Specification Matrix	Values
A Zero 2 3 Free	0 0 0 0 0 0	0 0 0 0 0 0
B Unit 2 3 Free	0 0 0 0 0 0	1 1 1 1 1 1
C Iden 3 3 Free	0 0 0 0 0 0 0 0 0	1 0 0 0 1 0 0 0 1
D Izero 2 5 Free	0 0 0 0 0 0 0 0 0 0	1 0 0 0 0 0 1 0 0 0
E Ziden 2 5 Free	0 0 0 0 0 0 0 0 0 0	0 0 0 1 0 0 0 0 0 1
F Diag 3 3 Free	1 0 0 0 2 0 0 0 3	? 0 0 0 ? 0 0 0 ?
G Sdiag 3 3 Free	0 0 0 1 0 0 2 3 0	0 0 0 ? 0 0 ? ? 0
H Stand 3 3 Free	0 1 2 1 0 3 2 3 0	1 ? ? ? 1 ? ? ? 1
I Symm 3 3 Free	1 2 4 2 3 5 4 5 6	? ? ? ? ? ? ? ? ?
J Lower 3 3 Free	1 0 0 2 3 0 4 5 6	? 0 0 ? ? 0 ? ? ?
K Full 2 4 Free	1 2 3 4 5 6 7 8	? ? ? ? ? ? ? ?

More detail on specifying parameters in matrices is given in Sections 4.4 to 4.5.

4.2 Building Matrix Formulae

Readers unfamiliar with matrix algebra may benefit from reading Appendix C, where examples and exercises are given. Readers familiar with matrix algebra may wish to examine Tables 4.4 and 4.5 for the variety of available operators and functions, and use this section for reference.

Matrix Operations

In ordinary algebra, operators such as $+$ $-$ \times and \div have an order of evaluation established by convention. Multiply and divide are done before addition and subtraction. Multiply and divide are done in left-to-right order if they appear consecutively, as are addition and subtraction. We could say then, that \times and \div have priority 1, and $+$ and $-$ have priority 2. Default priorities can be changed with the use of brackets $()$ which specify that operations inside the brackets are done first. For example, $a+b\times c=a+bc$ whereas $(a+b)\times c=ac+bc$.

A similar hierarchy has been established for the matrix operators in MX, and it too may be revised by the use of brackets. Table 4.4 shows the matrix operators and their (default) order of evaluation. Matrix algebra is subject to certain rules of conformability - requirements about the size and shape of the matrices being multiplied etc. These rules are listed in the right hand column of table 4, where r_A denotes rows in matrix **A** and c_B columns in matrix **B**. The number or rows of a matrix (r_A) and the number of columns of a matrix (c_A) are known as its dimensions. Two matrices **A** and **B** where $r_A=r_B$ and $c_A=c_B$ are said to have the same dimensions.

Table 4.4 Matrix operators available in MX, together with their priority for evaluation. See also Table 4.5 for matrix functions.

Symbol	Name	Function	Example	Priority	Conformability
\sim	Inverse	Inversion	$A\sim$	1	$r=c$
'	Transpose	Transposition	A'	1	none
\wedge	Power	Element powering	$A\wedge B$	2	none
*	Star	Multiplication	$A*B$	3	$c_A=r_B$
.	Dot	Dot product	$A.B$	3	$r_A=r_B$ and $c_A=c_B$
@	Kron	Kronecker product	$A@B$	3	none
&	Quadratic	Quadratic product	$A\&B$	3	$c_A=r_B=c_B$
%	Eldiv	Element division	$A\%B$	3	$r_A=r_B$ and $c_A=c_B$
+	Plus	Addition	$A+B$	4	$r_A=r_B$ and $c_A=c_B$
-	Minus	Subtraction	$A-B$	4	$r_A=r_B$ and $c_A=c_B$
	Bar	Horizontal adhesion	$A B$	4	$r_A=r_B$
_	Under	Vertical adhesion	A_B	4	$c_A=c_B$

A line has been drawn between the first two operators (Inverse & Transpose) and the rest because inverse and transpose are *unary* operators, that is, they operate on *one* matrix. The rest form a single new matrix from two matrices, and are thus *binary* operators. These operators are now described in detail.

Inverse \sim

Only square matrices may be inverted, but they may be either symmetric or non-symmetric. The inverse of matrix \mathbf{A} is usually written \mathbf{A}^{-1} and implies that $\mathbf{A}\mathbf{A}^{-1} = \mathbf{A}^{-1}\mathbf{A} = \mathbf{I}$ where \mathbf{I} is the identity matrix. To request an inverse with MX, we use the symbol \sim . If the inverse does not exist (possibly due to rounding errors), MX will terminate with an error message. Some precautions can be taken to avoid this, such as supplying starting values that allow inversion, or putting boundary constraints on parameters to prevent their taking values that would lead to a singular matrix.

Transpose $'$

Any matrix may be transposed. The transpose of \mathbf{A} is written \mathbf{A}' . The order of the matrix changes from $r \times c$ to $c \times r$, as the rows become the columns and vice-versa.

Power \wedge

All the elements of a matrix may be raised to a power using the \wedge symbol. Essentially, this operator works the same way as the Kronecker product (see below), but elements of the first matrix are raised to the power of those in the second matrix instead of multiplied by them. It is possible to use negative powers and non-integer exponents to indicate reciprocal functions and roots of elements, but it is not possible to raise a negative number to a non-integer power. For example, the cube of every element of a matrix would be obtained by $\mathbf{A} \wedge \mathbf{B}$ if \mathbf{B} was a 1×1 matrix with 3 as its only element.

For example, the matrix power $\mathbf{A} \wedge \mathbf{B}$ is

$$\begin{bmatrix} a & b \\ c & d \\ e & f \end{bmatrix} \wedge \begin{bmatrix} g & h \\ i & j \end{bmatrix} = \begin{bmatrix} a^g & a^h & b^g & b^h \\ a^i & a^j & b^i & b^j \\ c^g & c^h & d^g & d^h \\ c^i & c^j & d^i & d^j \\ e^g & e^h & f^g & f^h \\ e^i & e^j & f^i & f^j \end{bmatrix}$$

Multiplication $*$

$*$ or 'Star' is the ordinary form of matrix multiplication. The elements of $\mathbf{A}(m \times n)$ and $\mathbf{B}(n \times p)$ are combined to form the elements of matrix $\mathbf{C}(m \times p)$ using the formula $C_{ij} = \sum_{k=1}^n A_{ik} \times B_{kj}$. Matrices multiplied in this way must be *conformable for multiplication*. This means that *the number of columns in the first matrix must equal the number of rows in the second matrix*.

For example, the matrix product $\mathbf{A} * \mathbf{B}$

$$\begin{bmatrix} a & b \\ c & d \\ e & f \end{bmatrix} * \begin{bmatrix} g & h \\ i & j \end{bmatrix} = \begin{bmatrix} a \times g + b \times i & a \times h + b \times j \\ c \times g + d \times i & c \times h + d \times j \\ e \times g + f \times i & e \times h + f \times j \end{bmatrix} = \begin{bmatrix} ag + bi & ah + bj \\ cg + di & ch + dj \\ ge + fi & eh + fj \end{bmatrix}$$

Dot product .

Dot is another type of matrix multiplication, which is done *element by element*. For two matrices to be multiplied in this way, they must have the same dimensions. Elements of the dot product are described by the formula $C_{ij} = A_{ij} \times D_{ij}$.

For example, the dot product $\mathbf{A} \cdot \mathbf{D}$ is

$$\begin{bmatrix} a & b \\ c & d \\ e & f \end{bmatrix} \cdot \begin{bmatrix} g & h \\ i & j \\ k & l \end{bmatrix} = \begin{bmatrix} a \times g & b \times h \\ c \times i & d \times j \\ e \times k & f \times l \end{bmatrix}$$

Kronecker product \otimes

The *right* Kronecker product of two matrices $\mathbf{A} \otimes \mathbf{B}$ is formed by multiplying each element of \mathbf{A} by the matrix \mathbf{B} . If \mathbf{A} is of order $(m \times n)$ and \mathbf{B} is of order $(p \times q)$, then the result will be of order $mp \times nq$. There are no conformability criteria for this type of product. In MX input files the symbol \otimes is denoted with the symbol @.

For example, the Kronecker product $\mathbf{A} \otimes \mathbf{B}$ is

$$\begin{bmatrix} a & b \\ c & d \\ e & f \end{bmatrix} \otimes \begin{bmatrix} g & h \\ i & j \end{bmatrix} = \begin{bmatrix} a \times g & a \times h & b \times g & b \times h \\ a \times i & a \times j & b \times i & b \times j \\ c \times g & c \times h & d \times g & d \times h \\ c \times i & c \times j & d \times i & d \times j \\ e \times g & e \times h & f \times g & f \times h \\ e \times i & e \times j & f \times i & f \times j \end{bmatrix}$$

Quadratic product &

Many structural equation and other statistical models use quadratic products of the form $\mathbf{A} \mathbf{B} \mathbf{A}'$, and the quadratic operator is both a simple and efficient way to implement quadratics. Note that \mathbf{E} can be any shape, but to be conformable for quadratic product the matrix \mathbf{B} must be square and have the same number of columns as the matrix \mathbf{E} .

For example, the quadratic product $\mathbf{E} \& \mathbf{B}$

$$[a \quad b] * \begin{bmatrix} g & h \\ i & j \end{bmatrix} * \begin{bmatrix} a \\ b \end{bmatrix} = [a^2g + abi + abh + b^2i]$$

Element division %

% does *element by element* division. For two matrices to be divided in this way, they must have the same dimensions. Elements of the result, **C** are described by the formula $C_{ij} = A_{ij} \div D_{ij}$. If any element of **D** is zero, the corresponding cell in the result matrix is set to 10^{35} .

For example, the division **A%D** is

$$\begin{bmatrix} a & b \\ c & d \\ e & f \end{bmatrix} \% \begin{bmatrix} g & h \\ i & j \\ k & l \end{bmatrix} = \begin{bmatrix} a \div g & b \div h \\ c \div i & d \div j \\ e \div k & f \div l \end{bmatrix}$$

Addition +

Addition of matrices is performed *element by element*. For two matrices to be added, they must have the same dimensions. Elements of the sum, **C** are described by the formula $C_{ij} = A_{ij} + D_{ij}$.

For example, the sum **A+D** is

$$\begin{bmatrix} a & b \\ c & d \\ e & f \end{bmatrix} + \begin{bmatrix} g & h \\ i & j \\ k & l \end{bmatrix} = \begin{bmatrix} a + g & b + h \\ c + i & d + j \\ e + k & f + l \end{bmatrix}$$

Subtraction -

Subtraction of matrices is performed *element by element*. For one matrix to be subtracted from another, they must have the same dimensions. Elements of the difference, **C** are described by the formula $C_{ij} = A_{ij} - D_{ij}$.

For example, the difference **A-D** is

$$\begin{bmatrix} a & b \\ c & d \\ e & f \end{bmatrix} - \begin{bmatrix} g & h \\ i & j \\ k & l \end{bmatrix} = \begin{bmatrix} a - g & b - h \\ c - i & d - j \\ e - k & f - l \end{bmatrix}$$

Note that in MX there is also a *unary* minus operator, so that an expression such as $-\mathbf{A}$ is legal. This operation changes the sign of each element of **A**.

Horizontal Adhesion |

Bar allows partitioning of matrices. Its operation is called horizontal adhesion because $\mathbf{A|D}$ is formed by sticking \mathbf{D} onto the right hand side of \mathbf{A} . For two matrices to be adhered in this way, they have to have the same number of rows. If \mathbf{A} ($m \times n$) and \mathbf{D} ($m \times p$) are adhered, the result \mathbf{C} is of order ($m \times (n+p)$).

For example, the operation $\mathbf{A|D}$ is

$$\begin{bmatrix} a & b \\ c & d \\ e & f \end{bmatrix} | \begin{bmatrix} g & h \\ i & j \\ k & l \end{bmatrix} = \begin{bmatrix} a & b & g & h \\ c & d & i & j \\ e & f & k & l \end{bmatrix}$$

Vertical Adhesion _

Underscore allows partitioning of matrices. Its operation is called vertical adhesion because $\mathbf{A_D}$ is formed by sticking \mathbf{D} underneath \mathbf{A} . For two matrices to be adhered in this way, they must have the same number of columns. If \mathbf{A} ($m \times n$) and \mathbf{D} ($p \times n$) are adhered, the result \mathbf{C} is of order $((m+p) \times n)$.

For example, the operation $\mathbf{A_D}$ is

$$\begin{bmatrix} a & b \\ c & d \\ e & f \end{bmatrix} _ \begin{bmatrix} g & h \\ i & j \\ k & l \end{bmatrix} = \begin{bmatrix} a & b \\ c & d \\ e & f \\ g & h \\ i & j \\ k & l \end{bmatrix}$$

Matrix Functions

A number of matrix functions, shown in Table 4.5, may be used in MX. These are useful for in specialized applications involving user-defined fitting-functions (see p. 86).

Table 4.5 Matrix functions available in MX.
Restrictions are on rows r and columns c of input argument.

Keyword	Function	Restrictions	Result Dimensions
<code>\tr()</code>	Trace	$r=c$	1×1
<code>\det()</code>	Determinant	$r=c$	1×1
<code>\sum()</code>	Sum	None	1×1
<code>\prod()</code>	Product	None	1×1
<code>\max()</code>	Maximum	None	1×1
<code>\min()</code>	Minimum	None	1×1
<code>\abs()</code>	Absolute value	None	$r \times c$
<code>\cos()</code>	Cosine	None	$r \times c$
<code>\cosh()</code>	Hyperbolic cosine	None	$r \times c$
<code>\sin()</code>	Sin	None	$r \times c$
<code>\sinh()</code>	Hyperbolic sin	None	$r \times c$
<code>\tan()</code>	Tan	None	$r \times c$
<code>\tanh()</code>	Hyperbolic tan	None	$r \times c$
<code>\exp()</code>	Exponent (e^A)	None	$r \times c$
<code>\ln()</code>	Natural logarithm	None	$r \times c$
<code>\sqrt()</code>	Square root	None	$r \times c$
<code>\d2v()</code>	Diagonal to Vector	None	$\min(r,c) \times 1$
<code>\v2d()</code>	Vector to Diagonal	$r=1$ or $c=1$	$\max(r,c) \times \max(r,c)$
<code>\m2v()</code>	Matrix to Vector	None	$rc \times 1$
<code>\vec()</code>	Matrix to Vector*	None	$rc \times 1$
<code>\vech()</code>	Lower triangle to Vector	None	$rc \times 1$
<code>\stnd()</code>	Standardize matrix	$r=c$	$r \times c$
<code>\eval()</code>	Real eigenvalues	$r=c$	$r \times c$
<code>\evec()</code>	Real eigenvectors	$r=c$	$r \times r$
<code>\ival()</code>	Imaginary eigenvalues	$r=c$	$r \times 1$
<code>\ivec()</code>	Imaginary eigenvectors	$r=c$	$r \times r$
<code>\mean()</code>	Mean of columns	None	$1 \times c$
<code>\cov()</code>	Covariance of columns	None	$c \times c$
<code>\pchi()</code>	Probability of chi-squared	$r=1$ and $c=2$	1×2
<code>\pdfnor()</code>	Multivariate normal density	$r=c+2$	1×1
<code>\mnor()</code>	Multivariate normal integral	$r=c+3$	1×1
<code>\momnor()</code>	Moments of multivariate normal	$r \times 1$	$r \times 1$
<code>\allint()</code>	All integrals of multinormal		
<code>\aorder()</code>	Ascending sort order	$r \times 1$	$r \times 1$
<code>\dorder()</code>	Descending sort order	None	$r \times \max(1,c-1)$
<code>\sortr()</code>	Row sort	None	$\max(1,r-1) \times c$
<code>\sortc()</code>	Column sort	None	Variable [†]
<code>\part()</code>	Extract part of matrix		

*`\vec`: vectorizes by columns, in contrast to `\m2v`, which vectorizes by rows.

[†] `\part(A,B)` takes two arguments. The elements of the 1×4 matrix B are used to define a rectangle within matrix A to be extracted.

Functions, called with syntax of the form `\func(argument)` differ from operators because they take an *argument* enclosed by parentheses (). This argument may be a single matrix name, or a complex matrix formula. The argument is evaluated *before* the function is applied, consistent with the rules for using brackets. Functions form a second set of unary operators (see page 55). Descriptions of these functions follow.

Trace `\tr()`

The trace of a matrix is the sum of the elements on the leading diagonal, i.e.

$$\sum_{i=1}^n A_{ii}$$

It is only allowed for *square* matrices.

Determinant `\det()`

Properties of determinants, and ways of calculating them are discussed in Appendix C. This function is calculated for *square* matrices only.

Sum `\sum()`

The sum of a matrix is the sum of all its elements, i.e.,

$$\sum_{i=1}^r \sum_{j=1}^c A_{ij}$$

Product `\prod()`

The product function of a matrix yields the product of all its elements, i.e.,

$$\prod_{i=1}^r \prod_{j=1}^c A_{ij}$$

Maximum `\max()`

The maximum function of a matrix yields a 1×1 matrix containing the maximum of all its elements.

Minimum `\min()`

The minimum function of a matrix yields a 1×1 matrix containing the minimum of all its elements.

Absolute value `\abs()`

The abs function replaces all matrix elements with their absolute value.

Trigonometric functions `\cos()`, `\sin()` etc.

These functions replace all matrix elements with their appropriate trigonometric transformation, in radians.

Exponent \exp()

Any matrix is a legal argument for this function which replaces each element A_{ij} by $e^{A_{ij}}$.

Natural Logarithm \ln()

Any matrix is a legal argument for this function which replaces each element A_{ij} by $\ln A_{ij}$. If an element is less than 1×10^{-30} then the result is $\ln(1 \times 10^{-31})$. Although error messages would be more normal in such a situation, this behavior can be helpful in optimization.

Square Root \sqrt{}

Any matrix is a legal argument for this function which replaces each element A_{ij} by $\sqrt{A_{ij}}$. If an element is less than zero, a fatal error occurs.

Diagonal to Vector \d2v()

The leading diagonal of any matrix is placed into a column vector with $\min(\text{RbC})$ rows, i.e. r or c , whichever is less. e.g.

$$\text{if } A = \begin{bmatrix} a & 0 & 0 & 0 \\ 0 & b & 0 & 0 \\ 0 & 0 & c & 0 \end{bmatrix} \text{ then } \d2v(A) = \begin{bmatrix} a \\ b \\ c \end{bmatrix}$$

Vector to Diagonal Matrix \v2d()

A row or column vector is placed in the leading diagonal of a square matrix. e.g.

$$\text{if } E = [a \ b \ c \ d] \text{ then } \v2d(E) = \begin{bmatrix} a & 0 & 0 & 0 \\ 0 & b & 0 & 0 \\ 0 & 0 & c & 0 \\ 0 & 0 & 0 & d \end{bmatrix}$$

Matrix to Vector \m2v()

A matrix is placed in a column vector, by rows. Thus

$$\text{if } A = \begin{bmatrix} a & b \\ c & d \end{bmatrix} \text{ then } \m2v(A) = \begin{bmatrix} a \\ b \\ c \\ d \end{bmatrix}$$

This is similar to the function `\vec`; which places the matrix into a vector by columns, instead of rows.

Matrix to Vector `\vec()`

A matrix is placed in a column vector, by columns. Thus

$$\text{if } A = \begin{bmatrix} a & b \\ c & d \end{bmatrix} \text{ then } \backslash\text{vec}(A) = \begin{bmatrix} a \\ c \\ b \\ d \end{bmatrix}$$



Note that it is more efficient to use `\m2v(A)` than `\vec(A')` and more efficient to use `\vec(A)` than `\m2v(A')`. Both functions work for matrices of any shape.

Matrix to Vector `\vech()`

All the elements on the diagonal and below are placed into a vector, by columns. Thus

$$\text{if } A = \begin{bmatrix} a & b \\ c & d \end{bmatrix} \text{ then } \backslash\text{vech}(A) = \begin{bmatrix} a \\ c \\ d \end{bmatrix}$$

Like its counterparts `\vec` and `\m2v`, this function will operate on matrices of any shape, terminating at the last row or column, whichever is the smaller. Thus

$$\text{if } A = \begin{bmatrix} a & b \\ c & d \\ e & f \end{bmatrix} \text{ then } \backslash\text{vech}(A) = \begin{bmatrix} a \\ c \\ e \\ d \\ f \end{bmatrix}$$

Standardize `\std()`

This operation converts a covariance matrix into a correlation matrix. Replacement of elements is made according to the formula:

$$A_{ij}^* = \frac{A_{ij}}{\sqrt{A_{ii}A_{jj}}}$$

The diagonal elements of **A** have to be greater than zero, and **A** has to be square.

Real Eigenvalues \eval()

The real parts of the eigenvalues of a square matrix are placed in a column vector, in ascending order of size, smallest first.

Real Eigenvectors \evec()

The real parts of the eigenvectors of a square matrix are placed in a square matrix, where column j contains the eigenvector corresponding to eigenvalue j , with eigenvalues sorted in ascending order of size, smallest first ($j=1$).

Imaginary Eigenvalues \ival()

The imaginary parts of the eigenvalues of a square matrix are placed in a column vector, in ascending order of size, smallest first.

Imaginary Eigenvectors \ivec()

The imaginary parts of the eigenvectors of a square matrix are placed in a square matrix, where column j contains the eigenvector corresponding to eigenvalue j , with eigenvalues sorted in ascending order of size, smallest first ($j=1$).

Column Means \mean()

This function computes the means of the columns of a matrix.

Column Covariances \cov()

This function computes the covariance matrix of the columns of a matrix. Thus if data are presented as one line per subject, with r rows for each of the c variables, the output would be of order $c \times c$.

Probability of Chi-square \pchi(x)

Function `\pchi` computes the probability of a chi-squared with nu degrees of freedom. Its argument must be a 1x2 vector containing the chi-squared and degrees of freedom. It returns a 1x1 matrix. This can be useful when writing parameter estimates and fit statistics to a file.

Multivariate Normal Density \pdfnor(A)

The function `\pdfnor` computes the multivariate normal probability density function (pdf) given by the multivariate normal distribution. In the univariate case, this is the height of the normal curve. Matrix **A**, the argument of the function, is a $nvar+2 \times nvar$ matrix, containing: (first row) a vector of observed scores \mathbf{x}_i ; (second row) a vector of population means μ_i ; and (rows 3 to $nvar+2$) the population covariance matrix Σ . The pdf is

$$|2\pi\Sigma|^{-n/2} \exp\left(-\frac{1}{2}(\mathbf{x}_i - \mu_i)' \Sigma^{-1}(\mathbf{x}_i - \mu_i)\right)$$

Multivariate Normal Integration \mnor()

The matrix function `\mnor` will compute multiple integrals of the multivariate normal, up to dimension 10. Its input is structured so that for n dimensional integration, the matrix has n columns and $n+4$ rows. The first n rows define the covariance matrix, row $n+1$ defines the mean vector, the last three are used to define the type of truncation experienced by each variable. This is best described with an example. The script:

```

Test multivariate normal integral function
Data Calc NGroups=1
Matrices
  A Full 1 2 ! Upper limits
  B Full 1 2 ! Lower limits
  T Full 1 2 ! Type of integral
  R Stan 2 2 ! Covariance matrix
  Z Full 1 2 ! Means
Compute \mnor((R_Z_A_B_T)) /
Matrix R .3
Matrix B 0 0
Matrix A 1 1
Matrix T 2 2
Option RSiduals
End

```

computes the integral of the bivariate normal distribution with correlation .3 from 0 to 1 in both dimensions. The type parameters (matrix **T**) are flags that indicate the type of truncation required:

- 0 integral from $-\infty$ to a_j
- 1 integral from b_j to ∞
- 2 integral from a_j to b_j
- 3 integral from $-\infty$ to ∞ (this dimension is ignored)

where a_j and b_j are the elements of column j of matrices a and b.

Accuracy is set to six decimals by default. Lower precision may be set with Option `Eps=<value>` though it should be noted that this option will be treated globally, i.e., for all such integrals in a particular run.

Moments of the Truncated Multinormal \momnor()

The matrix function `\momnor` will compute moments of the truncated multinormal distribution. Currently, it will work only with 'tails' of the distribution, though selection may be absent for some variables. Here is a bivariate example:

```

Test moments of truncated normal function
Data Calc NGroups=1
Matrices
  R Symm 2 2 !covariance matrix
  M Full 1 2 !means
  T Full 1 2 !thresholds
  S Full 1 2 !selection vector
  N Full 1 2 !# of abscissae
Compute \momnor((R_M_T_S_N)) /
Matrix R 1 .5 1
Matrix M 0 0
Matrix T 1.282 1.282
Matrix S 1 1
Matrix N 16 16
Option RSiduals

```

End

This script requests the covariances and means of individuals selected above the threshold 1.282 in a $N(0,1)$ bivariate normal distribution. It returns the covariance matrix in the first n rows, and the means in row $n+1$.

!!

Note: this function can give incorrect results when the number of abscissae is small, or the thresholds are extreme (more than 3 standard deviations from the mean). CPU time will go up with the number of abscissae, but 64 is the maximum (and it goes in jumps 16 20 24 32 48 64, along with some smaller jumps below that). MX automatically assigns the number of abscissae to: i) 16 if you enter 0 or less, ii) 64 if you enter 64 or more, and iii) the next lowest value if you happen to chose an intermediate value (e.g. it will pick 24 if you enter 30).

All Intervals of the Multivariate Normal Distribution `\allint()`

It is often necessary to compute the probabilities of all the cells of a multivariate normal that has been sliced by a varying number of thresholds in each dimension. These thresholds are more formally called hyperplanes. While it is possible to use the `\mnorm` function to achieve this goal, it can be more efficient and more convenient to use the `\allint` function. The argument to the `\allint` function must be a matrix with as many columns as there are variables, and with as many rows as the number of columns plus 2 plus the maximum number of thresholds to be evaluated. The general form is `\allint(R_X_T_A)` where R is the $m \times m$ covariance matrix of m variables, X is the mean vector, T is a row vector whose elements t_i specify the number of thresholds in dimension i , and A contains the thresholds and is of order $(\max(t_i) \times m)$.

`\Allint` returns the proportions in all the cells, cycling from lowest to highest with the last variable in R changing most slowly. For example, the following script:

```
#NGroups 1
#define nvar 2      ! number of variables
#define maxthresh 3 ! maximum number of thresholds
Test of allint function
Calculation
Begin Matrices;
  A symm nvar nvar
  N full 1 nvar
  X full 1 nvar
  T full maxthresh nvar
End Matrices;

Matrix A 1 0 1 ! identity matrix here
Matrix X 0 0 ! zero means
Matrix N 2 3 ! first dimension has 2 thresholds (3 categories), second has 3
Matrix T
-1.282 -2.323 ! thresholds are -1.282 and 0 for first dimension,
  0      0 ! and are -2.323, 0 and 1.282 for second dimension
10 1.282 !
```

```

Begin Algebra;
C = \allint(A_X_N_T) ;
End Algebra;
End Group

```

will return:

MATRIX C

This is a computed FULL matrix of order 1 by 12

[=\ALLINT(A_X_N_T)]

	1	2	3	4	5	6	7	8	9
1	0.0010	0.0490	0.0400	0.0100	0.0040	0.1960	0.1601	0.0400	0.0050
	10	11	12						
1	0.2450	0.2000	0.0500						

containing the desired probabilities.

Ascending Order \aorder()

This function gets the ascending order of a column vector. For example, \aorder(A) with

$$A = \begin{pmatrix} 6 \\ 1 \\ 3 \end{pmatrix} \text{ would yield } \begin{pmatrix} 3 \\ 1 \\ 2 \end{pmatrix}$$

Descending order \dorder()

This function gets the descending order of a column vector. For example, \dorder(A) with

$$A = \begin{pmatrix} .6 \\ .1 \\ .3 \end{pmatrix} \text{ would yield } \begin{pmatrix} 1 \\ 3 \\ 2 \end{pmatrix}$$

Sort Rows \sortr()

Used to sort a column vector or matrix by rows. If a vector, the vector elements themselves are sorted. If a matrix, the first column is taken to be the sort order - and must contain a permutation of the integers 1 to the number of rows, as might be extracted using, e.g., \aorder() above.

Sort Columns \sortc()

This function works the same way as \sortr() but by columns.

Extract Part \part(A,B)

This function extracts a rectangular sub-matrix of matrix **A** (formerly this was possible only by pre- & post-multiplying by elementary matrices). One has to be very careful to initialize matrix **B** before this statement is given, because the result dimensions are needed to check syntax. To pre-initialize **B** you would use the following job structure

```

Title
  Calculation NGroups=1
  Begin Matrices;
    A Symm 3 3
    B Full 4 1
  End Matrices;      ! <- End matrix definitions with this statement
  Matrix A
    1
    2 3
    4 5 6
  Matrix B 2 1 3 3
  Compute \part(A,B) / ! <- Compute statement *after* matrix statement
  Option RSiduals
End

```

The format for matrix **B** is row, column, row, column so in this example the rectangle from 2,1 (row 2, column 1) to 3,3 will be extracted, giving

```

2 3 5
4 5 6

```



Note that the elements of **B** may define any two opposite corners of a submatrix of **A**. To some extent, the `\part()` function is binary, but we prefer to list it with the other matrix functions.

4.3 Using Matrix Formulae

A matrix formula is a sequence of matrix names and matrix operators terminated by a semicolon. For example

```
A*B + \m2v(C);
```

Covariances, Compute Command

Syntax:

```
Covariances/Compute formula;
```

The covariance command uses the matrices specified following the `Matrices` command and special symbols to perform operations or functions on or between them. A Covariance statement may contain a single matrix and no operations, or it could be very complex. The command may extend over several lines and *must end in a ; or /*. `Compute` is the recommended keyword for calculation groups, to make reading scripts easier for humans.

The primary method of carrying out matrix algebra is within an algebra section (see page 41). Matrices that appear on the left hand side should not already exist in that group.

Means Command

Syntax:

```
Means A formula;
```

The Means command operates in the same way as the Covariance command. It exists to facilitate the modeling of means. All the matrix operators and functions (Section 4.2) may be used just as when specifying a model for covariances. A ; or / must end the command. Currently, MX will do nothing with models for means when applying the functions LS, GLS, AWLS, DWLS. Only the ML, US and RM fit functions make use of models for means.

Threshold Command

Syntax:

Threshold A formula;

The Threshold command operates in the same way as the Means to specify thresholds. It enables modeling of thresholds when fitting to contingency table data. All the matrix operators and functions (Section 4.2) may be used just as when specifying a model for covariances. A ; or / must end the command. Threshold cannot be used with any fit function other than contingency table ML, which is used when CTable data have been supplied (see chapter 5).

Special restrictions apply to the dimensions of the matrix calculated in the Threshold command. The result must have 2 rows and must have at least d columns where $d = \max((r-1), (c-1))$, in other words, at least one less than the number of rows or the number of columns in the contingency table, whichever is the greater. The first $(r-1)$ elements of the first row of the matrix will contain the thresholds that separate the rows. The first $(c-1)$ elements of the second row of the matrix will contain the thresholds that separate the columns. These elements are unstandardized row and threshold estimates, which may be standardized by dividing by the square root of the product of the two diagonal elements of the expected covariance matrix calculated by the Covariance or Constraint statement. Use of unstandardized thresholds allows the testing of models that predict differences in variance between groups, but have equal thresholds.



The user should take care to supply starting values for thresholds that increase from left to right in both rows of the matrix calculated by the Threshold command. Ideal starting values are those that, when standardized, mark the z -scores on the normal distribution corresponding to the cumulative frequencies of the normal distribution of the row totals (first row of the calculated matrix) or the column totals (second row of the calculated matrix). For example, if the following contingency table was supplied as data:

```
CTable 3 2
20 180 40
360 20 180
```

then appropriate starting values for 2 row thresholds would be $-.67$ and $+.67$ (z -scores corresponding to the lower 25% and 75% of the normal distribution), and -1.28 would be appropriate for the starting value of the column threshold (z -score corresponding to the lower 10% of the normal distribution). Therefore if the threshold model was simply T, we would declare

```
T Full 2 2
```

and use

```
Matrix T -.67 .67 -1.28 0
```

to initialize it.

Weight command

Syntax:

Weight <formula> ;

where formula is a legal matrix algebra formula

The fundamental assumption of fitting a model to a population is that there is *only one* model. However, the population may consist of a mixture of groups which differ in the parameters or the entire structure of the model. In MX, the weight command, coupled with the `Nmodel` parameter, allow analysis of such mixtures when the raw data are available. `NModel` controls the number of models supposed to exist in the population. The predicted means and covariances are simply vertically stacked in the usual matrix expression for the means and covariances. For example, if three variables were being studied with one model, the predicted mean vector would be of order (1×3) and the predicted covariance matrix would be (3×3). If two models are being used, the predicted mean vector should be (2×3) and the predicted covariance matrix (6×3). MX checks that the size of the predicted covariance and mean vectors agree with the `NModel` and `NInput` (including any changes made with `Select/Definition` statements). `Weight` allows modeling of the likelihood that a particular observed vector is a member of a particular model class. The weight matrix expression should evaluate to a vector of order (`NModel`×1). The log-likelihood for a particular vector then becomes:

$$\ln L_{Nmodel} = \sum_{i=1}^{Nmodel} \ln (w_i L_i)$$

where w_i is the weight, L_i is the likelihood under the i^{th} model.

Often, the weights used will reflect simple proportions, and usually $\sum w_i = 1$. (see page 135 for an example). Sometimes, covariates may be used to compute the weight applied to a particular model. An example of such weighting is quantitative trait loci analysis where the probability that a pair of siblings have 0, 1 or 2 alleles in common at a particular place on the genome can be used to weight their likelihood under three models (Eaves et al., 1996).

Frequency Command

Syntax:

Freq <formula> ;

where formula is a legal matrix algebra formula

For maximum likelihood analysis of raw continuous data, it is possible to enter a formula for the frequency of the individual observations. For a constant frequency that does not change across the individual cases, this formula could be a scalar (1×1) matrix with the weight in it. More commonly it is desired that the frequency changes across the observations, in which case the use of definition variables to assign variables read in as data to the elements of matrices may be used.

4.4 Putting Numbers in Matrices

This section describes three methods of entering numbers into matrices (see Section 4.5 for how to specify elements of matrices to be free, fixed or constrained parameters). In Section 3.1, we saw how matrices could be declared as one of 11 types, such as identity, symmetric, diagonal or full (see Table 4.1), and how their dimensions (rows, r and columns, c) were specified. On inspection of the table, we see that types `Zero`, `Identity` `Identity|Zero` and `Zero|Identity` (`IZ`) have no free elements at all. For example, there is nothing more to know about an `IZ` matrix which has 2 rows and 4 columns. It looks like this:

$$\begin{pmatrix} 1 & 0 & 0 & 0 \\ 0 & 1 & 0 & 0 \end{pmatrix}$$

and it *cannot be changed at all*. If it was altered, then it would no longer be an `IZ` matrix.

All six remaining matrix types have *modifiable* elements which may be altered with the commands `Matrix`, `Start` or `Value`. The number of modifiable elements varies according to:

- The number of rows and columns in the matrix
- The *type* of the matrix

All modifiable elements of a matrix are initialized at zero. The order of elements in a matrix is left to right, by rows. For example, a symmetric (3×3) matrix would be read as:

```
1
2 3
4 5 6
```

See Table 4.3 for more examples on the patterning of matrices.

Matrix Command

Syntax:

```
Matrix <matrix name> {File=filename} <numlist>
```

where <numlist> is a free format list of numbers.

Note that different syntax is required in multiple fit mode:

```
Matrix <group number> <matrix name> {File=filename} <numlist>
```

The `Matrix` command supplies a list of values for the modifiable elements of a matrix. The list length required varies according to matrix type, and size as described at the start of this Section, on page 71. For example, suppose we specify a diagonal matrix **A** with 3 rows and 3 columns. The fourth column in Table 4.1 shows that the number of free elements is equal to r for diagonal elements, so we supply r elements. The command lines

```
Matrix A .3 5 9
```

or, equivalently

```
Matrix-I-would-like-to-change-is A
0.3D+00 5 9.00000000
```

would result in matrix **A** as:

$$\begin{pmatrix} .3 & 0 & 0 \\ 0 & 5 & 0 \\ 0 & 0 & 9 \end{pmatrix}$$

The `Matrix` command operates regardless of whether elements have been specified as fixed or free parameters.

`Matrix` will read its elements from a file with a FORTRAN format on the first line. Such files may have been produced by an earlier run of `MX`, or by another program. LISREL matrix output files (produced by commands such as `gamma=filename` on the LISREL `OU` line) are fully compatible. The files must contain at least as many numbers as required to fill the changeable elements of the matrix specified (see page 71).



`MX` always expects a format, so a `*` should be supplied for matrices in free format (numbers separated by blanks and carriage returns).

Start and Value Commands

Syntax:

`Start/Value <value> <element list>/ All`

where <element list> consists of matrix elements (e.g. A 1 2 3) and may include the TO keyword

In a large matrix, it is not convenient to provide a value for all the elements of a matrix, when only a few need to be modified. Under these circumstances, it is easier to explicitly change elements by *name*. Elements may be referred to by up to three subscripts, according to the syntax

`A {<group>} <row> <col>`

If the matrix you wish to refer to is in the current group, the group number may be omitted. The numbers `<group> <row> <col>` may be separated by any number of non-numeric or blank characters, so that, for example, to put .5 in row 2 column 3 of group 1's **A** matrix, you could enter:

`Value.5 A 1 2 3`

will work the same as

`Value.5 A(1,2,3)`

N.B. It is only possible to modify matrices declared in the current or previous groups.

`Value` and `Start` recognize `#define`'d variables (see page 40). For example. We could have the statements

`#define first 1`

`#define rowsinA 6`

`#define colsinA 10`

at the top of the script, and then

`Value 1.5 A first 1 1 to A first rowsinA colsinA`

would set 1.5 to all the fixed (non-free) elements of **A**, from `A 1 1` to `A 6 10`.

The difference between `Start` and `Value` lies in their treatment of elements when the keywords `ALL` or `T0` are used (`-` is a synonym for `T0`). With the keyword `ALL`, `Start` assigns a starting value to every free parameter specified at that point in the input file. `Value` does the opposite -- it assigns its value to every *fixed* matrix element specified up to that point. Although `Start` does the same thing if the `T0` keyword is specified, i.e. only apply its value to free parameters, `Value` behaves differently. It will assign a value to all elements in the same specified range, free parameter or fixed.

The `T0` keyword should be used only to specify a range of matrix elements *within the same matrix*.

4.5 Putting Parameters in Matrices

Parallel to the placement of numbers in matrices described in Section 4.4, there are facilities for putting parameters in matrices. Note also that all modifiable elements of a matrix can be specified as different free parameters using the keyword `Free` after the matrix is specified (see Section 4.1), and that building models with this in mind can be much faster and more flexible (see Chapter 1).

Pattern Command

Syntax:

Pattern <matrix name> {File=filename} <numlist>

where <numlist> is a list of 1's and 0's.

Note that different syntax is required in multiple fit mode:

Pattern <group number> <matrix name> {File=filename} <numlist>

The `Pattern` command is a simple method that has the same syntax as the `LISREL` command on which it was based. Following the `Pattern` command, the user must provide the correct number (see `Matrix` command page 71) of 1's and 0's for that matrix. A 1 (or any non-zero value) indicates that the element is a free parameter (which may be constrained to equal another free parameter - see the `Equate` command on page 74), and a 0 indicates that the element is fixed.

Fix and Free Commands

Syntax:

Fix/Free <value> <element list>

where <element list> is a list of modifiable matrix elements

The `Fix` and `Free` commands operate directly on specific matrix elements or sets of matrix elements. `Fix` makes a parameter fixed (if it was `Free` before) and `Free` makes an element a free parameter to be estimated. Matrix elements are referred to by group, row and column as described in page 72. The keywords `T0` and `ALL` may be used to specify ranges of matrix elements to be fixed or freed. See page 99 for alternative methods to fix parameters.

For example, suppose in group 1, matrix **A** was defined as symmetric, with 4 rows and columns. Initially it would be patterned with zeroes throughout. The command

Free a 1 2 1 - a 1 4 3
would give the following pattern:

$$\begin{pmatrix} 0 & 1 & 3 & 6 \\ 1 & 2 & 4 & 7 \\ 3 & 4 & 5 & 8 \\ 6 & 7 & 8 & 0 \end{pmatrix}$$

if this command was followed by
Fix A 1 4 2
the parameter specification would become:

$$\begin{pmatrix} 0 & 1 & 3 & 6 \\ 1 & 2 & 4 & 0 \\ 3 & 4 & 5 & 8 \\ 6 & 0 & 8 & 0 \end{pmatrix}$$

In symmetric matrices, references to the upper triangle are legal; anything done to an element one side of the diagonal (A_{ij}) is done to the corresponding element on the other side (A_{ji}).

Equate Command

Syntax:

```
Equate <matrix> {<gp>} <r> <c> <matrix> {<gp>} <r> <c> ... }
```

In order to constrain matrix elements to equal one another, the `Equate` command may be used. Its primary purpose is to specify equality constraints among parameters, but it can be used to copy a numeric value from one matrix element to another. There is a big conceptual difference between the *first* element specified in a list and the others. The fixed or free status of the first element is given to the remaining elements in the list, be they fixed or free. If the first element is a free parameter, the same parameter is copied to the other elements. If the first element is fixed, then a warning message is printed, to the effect that all other elements will be fixed. The value in the first element is then passed to the other elements in the list. The `Equate` command may be used within matrices, or across matrices in the same group, or across matrices in different groups. Note that it is *not* possible to use `Equate` to make an immovable element (such as an element of a matrix specified as type `ID`, or an off-diagonal element of a diagonal matrix) into a free parameter.

For example, given matrices specified in group 1 as follows:

```
Begin Matrices;
  A Symm 3 3 Free
  B Full 2 4
  I Identity 6 6
End Matrices;
```

the following Equate statements are legal:

```
Equate A 1 1 B(2,2) B 1 4
Equate B 2 1 A 1 2 3
Equate BANANA 2 2 APPLE 1 1 1
```

However, the following are *illegal*:

```
Equate A 1 1 I 2 2 (a)
Equate I 5 5 B 1 1 (b)
Equate A 1 2 C 1 1 (c)
Equate A 4 4 B 1 1 (d)
Equate A 2 2 G 4 1 1 (e)
```

They fail because: **I** is an identity matrix (a & b), **C** has not been specified (c), **A** does not have 4 rows and columns (d), and it is not possible to refer to an element of a matrix in a later group (e).

For large models with many constraints it is often more efficient to use the `Specification` command, or to seek repetitive structures in the model matrices and use partitioned matrices (see Chapter 1), or both. The kronecker product can be particularly useful when specifying repetitive partitioned matrix structures.

Specification Command

Syntax:

```
Specification <matrix name> a { b {c}}
```

where *a*, *b* and *c* are not necessarily distinct integers.

Note that different syntax is required in multiple fit mode:

```
Specification <group number> <matrix name> a { b {c}}
```

Following the `Specification` command, the user supplies a list of numbers that varies in length according to the dimensions and type of the matrix (see Section 4.4). If a zero is supplied, it indicates that the element is to be fixed. Non-zero elements refer to free parameters, and the same number refers to the same parameter. For example, the command

```
Specification A
1 2 3 0 0 0
0 0 0 3 2 1
```

would be equivalent to the statements

```
Pattern A
1 1 1 0 0 0
0 0 0 1 1 1
Equate A 1 1 A 2 6
Equate A 1 2 A 2 5
Equate A 1 3 A 2 4
```

The second method becomes tedious and error-prone in large models.

Note that the `Specification` and `Pattern` commands cannot be mixed in the same MX job. This is for safety, because the opportunities for user error are too large.

Boundary Command

Syntax:

Bound low high <parlist> / ALL

where <parlist> is a list of matrix elements or a list of parameter Specification numbers.

Boundary Constraints

By default, parameters to be estimated are constrained to lie between -10000 and +10000. These limits can be increased or decreased with the Bound command. Boundaries may be supplied more than once for any parameter, but only the last Bound statement referring to a particular element is used. For example the statements

```
Boundary -1 1 all
```

```
Boundary .3 5 a 1 4 6 a 1 5 6
```

would change the limits for all parameters to -1 and +1, except those (if any) in elements A 1 4 6 and A 1 5 6. The T0 syntax may be used to specify ranges within matrices, so that

```
Boundary 0 1 X 1 2 to X 1 6
```

would make parameters in all elements between X 1 2 and X 1 6 lie take values between zero and one. If the Specification command has been used to specify parameters in matrices, then it may be easier to refer to parameters with these numbers in a Bound command. Thus

```
Specification A
```

```
0 2 4 6
```

```
2 0 6 7
```

```
Boundary 0 10 2 4
```

would be permitted as a method of bounding parameters 2 and 4 to lie between zero and ten.

Linear and Non-Linear Inequality Constraints

See page 49 on the use of constraint groups to implement inequality constraints.

4.6 Label Matrices and Select Variables

Labeling Matrices

Syntax:

Labels Row/Column <matrixname> <label-list>

After matrices have been declared, whether within a Matrices or Algebra section, labels may be given for the row or column (or both) of any matrix that has free elements. Matrices without free elements (Zero, Identity, Identity|Zero, and Zero|Identity and Unit) are never displayed so labels provided for these matrices will not appear on the output. The label-list contains labels separated by blanks or carriage returns. Labels *must not begin with a number* and may be up to 8 characters long. More characters can be read, but MX only regards the first eight as significant, and will only print the first eight on the output.

Labels may be given for the observed data by issuing a Label command before the matrices command, as described in Section 4.6.

Identification Codes

Syntax:

ICodes <numlist>

where <numlist> is a number list of length NInput_vars.

The ICodes command may be used in conjunction with the VL or rectangular data to specify a non-standard structure of the expected covariance matrix. It may be thought of as a select command which operates on the *predicted* covariance matrix and *predicted* mean vector. By default, the identification codes for the covariance matrix are 1 2 3 4... For example, if NInput_vars=3 then by default the expected covariance matrix has a structure like this:

$$\begin{matrix} & \begin{matrix} 1 & 2 & 3 \end{matrix} \\ \begin{matrix} 1 \\ 2 \\ 3 \end{matrix} & \begin{pmatrix} V_1 & & \\ C_{12} & V_2 & \\ C_{13} & C_{23} & V_3 \end{pmatrix} \end{matrix}$$

From which structure it would be possible to read data in a VLength file that had forms:

```
1
1 .1
1
2 .2
1
3 .3
2
1 2 .1 .2
2
1 3 .1 .3
2
2 3 .2 .3
3
1 2 3 .1 .2 .3
```

and any of these could be reordered. For example, if the following VLength data were input:

```
2
3 1 .9 .4
```

MX would generate a covariance matrix of the form

$$\begin{matrix} & \begin{matrix} 3 & 1 \end{matrix} \\ \begin{matrix} 3 \\ 1 \end{matrix} & \begin{pmatrix} V_3 & \\ C_{13} & V_1 \end{pmatrix} \end{matrix}$$

if means are being estimated, they will also be selected appropriately, in this case selecting μ_3, μ_1 from an initial vector $(\mu_1 \mu_2 \mu_3)$.

The `ICodes` command allows the default order 1 2 3... to change, making an infinite variety of input data vectors readable. The repetition of a number is most useful for pedigrees of variable structure, for example, if the model generates the covariance between two parents and two children, data that come from families with more than two children may be handled. In this case, the `ICodes` command would be:

```
ICodes 1 2 3 3
```

And thus the covariance matrix looks like this:

$$\begin{matrix} & F & M & C_1 & C_2 \\ \begin{matrix} F \\ M \\ C_1 \\ C_2 \end{matrix} & \begin{pmatrix} V_F & & & \\ C_{FM} & V_M & & \\ C_{FC} & C_{MC} & V_C & \\ C_{FC} & C_{MC} & C_{CC} & V_C \end{pmatrix} \end{matrix}$$

If the following `VLength` data were read:

```
3
3 3 3 .2 .4 .6
```

then `MX` would create the following covariance matrix for this data structure:

$$\begin{matrix} & C_1 & C_2 & C_3 \\ \begin{matrix} C_1 \\ C_2 \\ C_3 \end{matrix} & \begin{pmatrix} V_C & & \\ C_{CC} & V_C & \\ C_{CC} & C_{CC} & V_C \end{pmatrix} \end{matrix}$$

The fact that two 3's have been given allows the generation of the expected covariance matrix between any number of individuals with code 3.

5 Options for Fit Functions and Output

What you will find in this chapter

- Details on the built-in fit functions
- How to use other fit functions
- How to increase or decrease the output
- Confidence intervals and standard errors
- Power calculations
- Changing the technical optimization parameters
- Fitting submodels with multiple fit
- Writing matrices to files
- Saving jobs and results to binary files
- How to create RAMpath diagrams

5.1 Options and End Commands

Syntax:

Options <multiple> <fitfunc> <statout> <optimpar> <write> End \

where <multiple> starts multiple fit mode, <fitfunc> specifies the fit function, <statout> requests statistical output, <optimpar> requests optimization parameters, and <write> specifies the filenames to write matrices to files

The `Option` lines of MX allow the specification of a wide variety of keywords and parameters to control the type of fit function used, the amount of output requested, file names for result matrices, and many others. The `Option` command does not signify the end of a group, so several `Option` lines may be given within any group. `Option` commands should follow `Model` or `Covariance` statements, and should not be followed by `Bound` commands. To end a group, the `End Group;` command is used, for example,

```
Option Mxa=Afile.out
Option RSiduals NAG=30
End Group;
```

5.2 Fit Functions: Defaults and Alternatives

The fit function for a group is automatically set according to the type of data that are read. For example, if covariance matrices alone are read, the default is maximum likelihood. Table 5.1 shows the default fit functions selected by MX for a given data input. Note that the method may change between groups. If a function that does not asymptote to χ^2 (e.g. RU or RM) is used in any group, then no χ^2 probability is given at the end of optimization. In general, the default fit function is appropriate for the data supplied. MX does not provide for altering the input data from one type to another (e.g. converting a covariance matrix to a correlation matrix). However, it is a simple task to write a separate MX script to make this conversion.

Table 5.1 Default fit functions according to the type of data that have been read.

Input data	Default fit function
CMatrix, KMatrix or PMatrix	ML
CMatrix, KMatrix or PMatrix with ACov	AWLS
CMatrix, KMatrix or PMatrix with AVar	DWLS
Rawdata, VLength or Rectangular	RM
CTable	ML _N

CMatrix - covariance matrix; KMatrix/PMatrix - correlation matrix; ACov - asymptotic covariance matrix; AVar - asymptotic variance matrix; Rawdata - Raw data; VLength - variable length data; Rectangular - rectangular file; CTable - contingency table; ML - maximum likelihood; AWLS - asymptotic weighted least squares; DWLS - diagonal weighted least squares; RM raw maximum likelihood; ML_N - maximum likelihood assuming bivariate normal liability.

Standard Fit Functions

There are several good introductions to the properties of different fit functions (e.g Jöreskog & Sörbom, 1989; Bentler, 1989). Controversy exists about the relative merits of the different methods in the face of assumption violations (see Kaplan, 1990), and it seems wise for the user to treat this information in the same way as a white wine from the Loire (drink youngest available). Currently, maximum likelihood (ML) is showing robustness in the face of violations of the assumptions of multivariate normality. Asymptotic weighted least squares (AWLS) generally performs better in the presence of kurtosis, but can be at least as badly affected by skewness as ML. See however, simulation work by Rigdon and Ferguson (1991) for problems with tetrachoric correlations.

In the following sections, the calculation of the fit functions is described, where \mathbf{S} is the observed covariance matrix, $\mathbf{\Sigma}$ is the expected covariance matrix, $\text{tr}(\mathbf{A})$ indicates the trace of and $|\mathbf{A}|$ indicates the determinant of matrix \mathbf{A} . \mathbf{S} and $\mathbf{\Sigma}$ are of order p and df is one less than the sample size used to calculate \mathbf{S} .

Least Squares LS

The unweighted least squares fit function is calculated by the formula:

$$LS = df \left(\frac{\text{tr}(\mathbf{S} - \mathbf{\Sigma})^2}{2} \right)$$

Maximum Likelihood ML

When model fitting to covariance matrices, the maximum likelihood fit function is

$$ML = df (\ln|\mathbf{\Sigma}| - \ln|\mathbf{S}| + (\text{tr}(\mathbf{S}\mathbf{\Sigma}^{-1}) - p))$$

and this is modified when both a mean vector x and a model for the means μ (see page 68) are supplied, this function is augmented to become

$$ML_{C+M} = df(\ln|\mathbf{\Sigma}'| - \ln|\mathbf{S}'| + (\text{tr } \mathbf{S} \mathbf{\Sigma}^{-1})) - p + \frac{df+1}{df} (x - \mu)' \mathbf{\Sigma}^{-1} (x - \mu) + 1)$$

In order for the ML fit function to be calculated, $\mathbf{\Sigma}$ must be positive definite. If, during optimization, the determinant of \mathbf{S} is less than 10^{-30} then MX uses a penalty function or other methods to try to steer optimization back towards a positive definite solution. The penalty function is

$$100 \left(p^2 + 10^{33} \left(\frac{10^{-30} - |\mathbf{S}|}{|\mathbf{\Sigma}|} \right) \right)$$

If the starting values begin optimization in this region, it is difficult for the optimizer to escape this high plateau, so optimization may fail. To avoid this, starting values may be revised or the LSML fit function may be used to obtain sensible starting values for ML estimation. LSML first fits the model by least squares, then by maximum likelihood.

Generalized least squares GLS

Generalized least squares is based on the principles of Aitken (1934-35); see Browne (1974)

$$GLS = \frac{\text{tr}(\mathbf{I} - \mathbf{S}^{-1} \mathbf{\Sigma})^2}{2}$$

GLS operates for covariance matrices only.

Asymptotic weighted least squares AWLS

Asymptotic weighted least squares follows from work by Browne (1982, 1984) and others. Effectively, the variance covariance matrix of the observed summary statistics is used as a weight matrix \mathbf{W} . Formally the fit function is

$$AWLS = \sum_{i=1}^n \sum_{j=1}^i \sum_{k=1}^n \sum_{l=1}^k (S_{ij} - \Sigma_{ij}) \mathbf{W}_{ij,kl}^{-1} (S_{kl} - \Sigma_{kl})$$

By default, if a correlation matrix (KMatrix or PMatrix) is supplied, the above formula is modified to

$$AWLS_{KM} = \sum_{i=2}^n \sum_{j=1}^{i-1} \sum_{k=2}^n \sum_{l=1}^{k-1} (S_{ij} - \Sigma_{ij}) \mathbf{W}_{ij,kl}^{-1} (S_{kl} - \Sigma_{kl}) + \frac{df}{2} (1 - \Sigma_{ii})^2$$

The term $\frac{df}{2} (1 - \Sigma_{ii})^2$ exists to constrain the elements of the diagonal to equal one. If the

model fails to meet this constraint, the fit function is inflated. MX prints the amount of the fit function that is due to this component of model misspecification. The second term is not calculated (and does not contribute to the fit function) if the keyword `Diagonal` appears on the `Option` line.

An alternative approach to maintaining a diagonal of ones would be to standardize the expected covariance matrix before calculating the AWLS fit function. MX does this if the keyword `Standardize` appears on the `Options` line. Some care with starting values is needed here, because the solution for a model standardized in this way is necessarily *not* unique. A third approach would be to use a nonlinear constraint group (see Section 3.5) that constrains the diagonal elements to equal unity.

Diagonally weighted least squares DWLS

Diagonally weighted least squares is a simplified form of AWLS for use with large problems where the AWLS matrix becomes unmanageably large. It is a compromise with less statistical validity than AWLS and should be used with caution. `Select` does not work with DWLS to discourage its use. The fit function for DWLS is simply:

$$DWLS = \sum_{i=1}^n \sum_{j=1}^i (S_{ij} - \Sigma_{ij}) W_{ij,ij}^{-1} (S_{ij} - \Sigma_{ij})$$

where \mathbf{W} is a diagonal matrix of variances of the observed covariances. $\sum_{i=1}^n \sum_{j=1}^i$ is replaced by $\sum_{i=2}^n \sum_{j=1}^{i-1}$ if a correlation matrix is supplied as data.

Least Squares - Maximum Likelihood LSML

This fit function starts with unweighted least squares, and takes parameter estimates from the solution as starting values for maximum likelihood estimation. This method is useful to avoid having to specify starting values that generate a positive definite covariance matrix. Its disadvantage is that it consumes more computer time than would supplying appropriate start values and using ML alone. Though more robust to bad starting values, it is not infallible; optimization is not (yet) an exact science.

Maximum Likelihood Analysis of Raw Continuous Data

When we have a sample of complete multinormal data, the summary statistics of means and covariance matrices are sufficient statistics to obtain maximum likelihood estimates of parameters (see the keyword `ML` above). It is common practice to remove from analysis any subject that has missing data. However, there are occasions when missing data result in the omission of a significant amount of data from analysis. If the number of types of missing data is small, for example, if there are really two sub-populations, one that has data on 6 tests, and one that lacks data on the fourth test, then covariance matrices could be computed separately for the two populations and models fitted separately to the different groups. MX is flexible, allowing different groups to have different numbers of input variables.

This multi-group approach breaks down if the number of sub-populations is large and the sample size for each group is too small to estimate a positive definite observed covariance

matrix (this happens if the number of variables exceeds the number of subjects). For this reason, a number of methods of handling incomplete data are provided in MX. RM (raw maximum likelihood) is really an extension of the multigroup method described above, but calculates twice the negative log-likelihood of the data for each observation. The procedure follows the theory described by Lange et al., (1976). If there are k observed variables in the set, the normal probability density function of an observed vector \mathbf{x}_i is

$$|2\pi\boldsymbol{\Sigma}|^{-n/2} \exp\left(-\frac{1}{2}(\mathbf{x}_i - \boldsymbol{\mu}_i)' \boldsymbol{\Sigma}^{-1}(\mathbf{x}_i - \boldsymbol{\mu}_i)\right)$$

where $\boldsymbol{\Sigma}$ is the population covariance matrix and $\boldsymbol{\mu}_i$ is the (column) vector of population means of the variables, and $|\boldsymbol{\Sigma}|$ and $\boldsymbol{\Sigma}^{-1}$ denote the determinant and inverse of the matrix $\boldsymbol{\Sigma}$, respectively. The fit function is thus:

$$\text{RM} = -k \log(2\pi) + \log|\boldsymbol{\Sigma}| + (\mathbf{x}_i - \boldsymbol{\mu}_i)' \boldsymbol{\Sigma}^{-1}(\mathbf{x}_i - \boldsymbol{\mu}_i)$$

If there are incomplete data, a separate group could be constructed for each different type of data vector. This could be rather tedious for anything beyond a very few types of vector, so MX provides a second, more general approach. The approach is to create a variable length record or rectangular file (page 44). This allows the use of the above fit function, but with a variable length observed vector \mathbf{x} . The appropriate mean vector $\boldsymbol{\mu}$ and covariance matrix $\boldsymbol{\Sigma}$ is automatically created by MX for each observation. To save on computer time, the creation of $\boldsymbol{\mu}$ and $\boldsymbol{\Sigma}$ (and importantly $\boldsymbol{\Sigma}^{-1}$) is done only if a vector is different in structure from the previous vector. Therefore, considerable CPU-time saving can be obtained if sorted data are supplied to MX. An example script can be found on page 132. Individual likelihoods and related statistics can be written to a file (see p. 101).

Maximum Likelihood Analysis of Raw Ordinal Data

Data analysis proceeds by maximizing the likelihood under a multivariate normal distribution model. In order for this to take place, it is necessary to supply both a matrix formula for the covariances and a matrix formula for the thresholds. The covariance formula must result in a matrix which is square, symmetric⁸ and has the same order as the number of variables read in from the `Ordinal` file. The threshold statement must yield a matrix which has the same number of columns as the number of variables being analyzed. The number of rows of this matrix must match the maximum category of all of the variables in the data file, or if the highest statement is used, the largest value in the argument to this command. This maximum category of all is known as `maxcat`.

For a vector of observed ordinal responses $\mathbf{y} = (y_0, y_1, \dots, y_m)$, the likelihood is computed by the expected proportion in the corresponding cell of the multivariate normal distribution. Let the highest category of variable j be denoted by hj , and let t_{ij} denote the j^{th} threshold of variable i . The expected proportion in the categories of \mathbf{y} is computed as:

$$\int_{t_{1y_1}}^{t_{1y_1+1}} \int_{t_{2y_2}}^{t_{2y_2+1}} \dots \int_{t_{my_m}}^{t_{my_m+1}} \phi(\mathbf{x}), d\mathbf{x}$$

⁸ If the matrix is not symmetric, only the lower triangle will be used, but the use of non-symmetric predicted covariance matrices is confusing and is not generally encouraged

where $t_{0j} = -\infty$, $t_{nj} = \infty$, and $\phi(x)$ is the multivariate normal probability density function (pdf), given by

$$|2\pi\Sigma|^{-n/2} \exp\left(-\frac{1}{2}(x_i - \mu_i)' \Sigma^{-1}(x_i - \mu_i)\right)$$

in which Σ is the predicted covariance matrix of the variables, μ_i is fixed at zero for all i .

To illustrate in a trivariate case, the two vectors of observations

0 2 1

and

. . 1

would have likelihoods computed as:

$$\int_{-\infty}^{t_{11}} \int_{t_{22}}^{t_{23}} \int_{t_{31}}^{t_{32}} \phi(x_1, x_2, x_3), dx_3 dx_2 dx_1$$

If the third variable is binary, then the upper limit on integration would be $t_{32} = \infty$. For the second vector of observations, two measures are missing so the likelihood simplifies to the single integral:

$$\int_{t_{31}}^{t_{32}} \phi(x_3), dx_3$$

Tests of mean differences between populations may be carried out by adding a vector of constants to each row of the threshold matrix. This may be easiest to do via the Kronecker product of a $1 \times m$ vector of free parameters with a Unit column vector that has maxcat elements. This formulation is a *parametric model* for the distribution of ordinal responses. The parameters of the distribution are those that influence the predicted thresholds \mathbf{T} and the predicted covariance matrix Σ .

An especially important feature of the maximum likelihood raw data approach is that it provides a natural method of handling missing data that are so common in longitudinal and multivariate studies. In theory, data that are missing completely at random (MCAR) or missing at random (MAR) are correctly handled by this procedure and will provide unbiased maximum likelihood estimates as long as the assumptions of the multivariate normal hold (Little & Rubin, 1987). This is entirely analogous to the continuous case. Failure to include cases that contain missing observations can lead to bias in parameter estimates. Elimination of such cases will almost always lead to larger confidence intervals on all parameters.

A further advantage of the raw data approach is that it provides a natural way to exploit moderator variables, using the definition variable methods described on pages 33 and 133. At this time it is only possible to model binary variables via path diagrams in the graphical interface, because the GUI always generates a script with a single vector of means, and not a matrix of thresholds. In the case of binary variables, the method will work from diagrams because MX treats the mean and threshold statements equivalently.

An example of data analysis using this method may be found on the MX website at <http://views.vcu.edu/mx/examples/ordinal>

Contingency Table Analysis

MX has a built-in fit function for the maximum-likelihood analysis of 2-way contingency tables. Two-way tables are inherently bivariate, so we are implicitly fitting a 2×2 covariance matrix to the cell frequencies, and estimating a tetrachoric or polychoric correlation. Figure 5.2 shows a contour plot of the frequency distribution of two variables, X and Y .

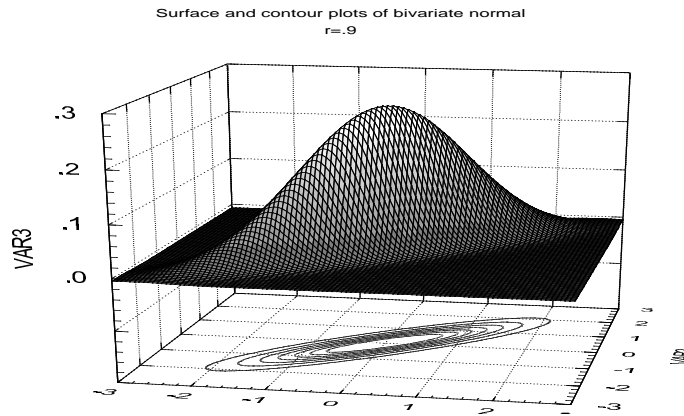

Figure 5.2 Contour plot showing a bivariate normal distribution with correlation $r=.9$ and two thresholds in the X and Y dimensions.

For an r by c contingency table, there are assumed to be $r-1$ row thresholds and $c-1$ column thresholds that separate the observed categories of individuals.

Twice the log-likelihood of the observed frequency data is calculated as:

$$\ln L_{CT} = \sum_{i=1}^r \sum_{j=1}^c 2n_{ij} \ln \left\{ \frac{n_{ij}}{n_{..} p_{ij}} \right\}$$

where n_{ij} is the observed frequency in cell ij , p_{ij} is the expected proportion in cell ij , and $n_{..}$ is the total number of observations in the contingency table. The expected proportion in each cell is calculated by numerical integration of the bivariate normal distribution, performed by subroutine BIVNOR (Schervish, 1984). For example, the expected proportion with individual 1 lying in the category between threshold a and threshold b and with individual 2 lying in the category between threshold c and threshold d would be given by:

$$L_{1,2} = \int_a^b \int_c^d \phi(v_1, v_2) dv_2 dv_1$$

where ϕ denotes the multinormal probability density function, and v_i is the liability of individual I .

Since n_{ij} is not estimated, the number of degrees of freedom associated with an $r \times c$ table is $rc-1$. If z cells have not been ascertained, the number of degrees of freedom is reduced by

z. In order to compute an approximate χ^2 statistic, twice the likelihood of the data under the model is subtracted from the likelihood of the observed data themselves, calculated as

$$\ln L_{\text{CTO}} = \sum_{i=1}^r \sum_{j=1}^c 2n_{ij} \ln \left\{ \frac{n_{ij}}{n_{..}} \right\}$$

See page 69 for details on specifying thresholds for models fitted to contingency table data, and page 122 for an example script.

Non-random Ascertainment

MX will automatically calculate an ascertainment correction while calculating the likelihood of the incompletely ascertained data. For example, if we ascertain a sample of 60 probands from hospital records and examine their spouses, of whom 10 are observed to have the same disorder, then a 2×2 contingency table would be supplied as follows:

```
CTable 2 2
-1 -1
50 10
```

The -1 in the cells of the first row indicate that subjects were not ascertained in these areas. The likelihood of the observed data must be corrected for the incomplete ascertainment of subjects for study. Effectively, as we omit certain classes of person from observation, so the likelihood of observing the remaining individuals increases. Mathematically this is expressed by dividing the likelihood by the proportion of the population remaining after ascertainment. We obtain this by subtracting the proportions in all omitted classes from the total population proportion (i.e. 1.0). In our example, assuming that individual 1 has to be above threshold, the proportion omitted is

$$\tilde{A} = \int_{-\infty}^t \int_{-\infty}^t \phi(v_1, v_2), dv_2 dv_1 + \int_{-\infty}^t \int_t^{\infty} \phi(v_1, v_2), dv_2 dv_1$$

where t is the ascertainment threshold, v_1 and v_2 are the liability values of individuals 1 and 2, and ϕ is the multinormal probability density function. The likelihood corrected for ascertainment would simply be the likelihood as obtained before, but divided by $1 - \tilde{A}$.

User-defined Fit Functions

If the User-defined keyword appears on the Options line, the fit function for the group is to be user specified. In order for this to be the case, the matrix expression given as the model (Constraint or Covariance command) *must evaluate to a scalar*. There are no other rules. Any of the automatically defined fit functions LS, ML, AWLS etc. could be specified as user-defined functions, but it is generally less efficient to do so. User-defined functions are recommended only when the built-in functions are not suitable. A simple example is shown on page 140.

5.3 Statistical Output and Optimization Options

In this Section we discuss some of the statistics that MX will compute automatically. While the range of these statistics is limited, the user should note that it is quite straightforward to compute his or her own functions of the parameters or goodness of fit statistics using calculation groups (see Section 3.5 for syntax and page 112 for an example script that computes standardized estimates).

Standard goodness-of-fit output

At the end of optimization, MX prints the value of the fit function, which is asymptotically distributed as χ^2 when the fit function is maximum likelihood and the data are covariance matrices. Similar distributional properties are thought to hold for generalized least squares, the contingency table likelihood fit function, and asymptotic weighted least squares. For these functions, the degrees of freedom and probability are printed, together with Akaike's Information Criterion, computed as χ^2-2df . The degrees of freedom are calculated as the number of observed statistics minus the number of observed statistics plus the number of non-linear constraints. To be judged a good fit, models should have a non-significant chi-squared ($p>.05$). With large sample sizes, significant chi-squared can come from relatively trivial failures of the model; alternative comparative fit statistics (see p. 94) can be used for these cases. Confidence intervals on the goodness-of-fit χ^2 may be printed using option CI.

User-defined fit functions and raw data maximum-likelihood are not treated as being distributed as chi-squared, so the probability is not computed by default. However, sometimes the user-defined fit-function will indeed be appropriately distributed, so the option ISCHI can be used to override this default behavior. An example where this would be appropriate is where the value of twice the log-likelihood from a saturated or super model $-2\ln L$ had been entered as a user-defined fit function group, and option df used to adjust the degrees of freedom to the difference between the models.

RMSEA

Root Mean Squared Error Approximation, or RMSEA (Steiger & Lind, 1980; McDonald, 1989), is a goodness-of-fit index which is automatically printed by MX after fitting a model that results in a chi-squared goodness-of-fit. The primary aim of this statistic is to provide a measure of fit that is relatively independent of sample size. Essentially, it is a weighted sum of discrepancies. Values below .10 indicate a good fit, and values below .05 indicate a very good fit. The index is computed by

$$RMSEA = \sqrt{(\chi^2 - df) / n} / df$$

for the single group case. In the multigroup case, a different formula is used. Following an unpublished manuscript by Dr. Steiger, the index is effectively multiplied by the square-root of the number of groups, when the same number of variables is analyzed in each group. MX also makes adjustments for different numbers of variables being in each group, although this is highly experimental at present. For now, it is sufficient to note that the multigroup

RMSEA is corrected from the original formula. RMSEA should be viewed skeptically when the groups do not have the same number of variables.

Suppressing Output

Syntax:
Option NO_Output

Before describing ways in which MX output can be increased, we note the valuable option NO_Output which prevents printing of all output for a group. This option should be used by the ecologically-minded as often as possible. Even the environmentally unconscious may find it useful to reduce their disk-space usage, but some caution should be taken not to use it too frequently since valuable information that could reveal misspecification of the model might be missed.

Appearance

Syntax:
Option NDecimals=*n* or Width=*m*
where n is the number of decimal places, and m is the number of columns

By default, MX will print most numbers with three decimal places, or use exponential format if there are very small or very large numbers in a matrix. You may override this default with the NDecimals keyword, where NDecimals=*n* will print *n* decimal places of precision.

MX prints up to 80-columns of output, which is suitable for viewing on an 80-column display or legal/letter/A4 paper (in portrait orientation) with a 10cpi font. This default may be changed with the option Width=*m* where *m* is the number of columns desired. At the present time, the NDecimals and Width parameters cannot be used together (sorry).

Residuals

Syntax:
Option RSiduals

The RSiduals keyword requests that the observed matrix, the expected matrix, and the residuals (observed - expected) be printed. In calculation and constraint groups, only the expected matrix is printed, since neither has any data. Note that RSiduals is the only way to print the observed matrix, and may be especially useful if the Select command has been used. When means have been supplied, the observed and expected mean vectors will be printed. Expected means also appear when using maximum likelihood with raw data. With contingency tables, MX prints the observed and expected frequencies and their difference.

Under asymptotic weighted least squares MX prints two types of residual matrix. First, it prints the unweighted difference between the observed and expected correlations or covariances. Second, it prints a *weighted residual matrix*, which is calculated from the formula (see page 80):

$$WRes_{ij} = \sum_{k=2}^n \sum_{l=1}^{k-1} (S_{ij} - \Sigma_{ij}) W_{ij,kl}^{-1} (S_{kl} - \Sigma_{kl}) + \frac{df}{2} (1 - \Sigma_{ii})^2$$

The sum of these elements gives the fit function for the group (neglecting any penalty function for the diagonal of a correlation matrix). Note that not all elements will be positive, but that their sum is necessarily non-negative. Quite often, inspection of the weighted residuals will give a clearer idea of the cause of model failure than consideration of the unweighted residuals alone.

Adjusting Degrees of Freedom

Syntax:

Option DFreedom=*n*

where *n* is the adjusted number of degrees of freedom

If a correlation matrix is read instead of a covariance matrix, the number of statistics provided is usually less than when variances are also given. The amount of the reduction in information depends on the structure of the data. For example, if MZ and DZ twins have been measured on one variable, there are four statistics that are necessarily equal (the variances of twin 1 and twin 2 in the MZ and DZ groups). Only one of these statistics confers any information (it scales the size of the MZ and DZ covariances), so three degrees of freedom are lost, and DF=-3 should be placed on the Options line. For multivariate twin data, DF=-3*k* should be used, where 3*k* is three times the number of variables on which each twin is measured. We can extend this idea to *m* groups of pedigrees of size *n*, each measured on *k* variables, in which case *df*=-*k*(*mn*-1) should be used.

Power Calculations

Syntax:

Option Power=*alpha*,*df*

where *alpha* is the probability level of the test, and *df* are the associated degrees of freedom

Power calculations are useful in a wide variety of contexts, especially experimental design and getting grants. For theoretical work, once one has established that it is possible in principle to detect an effect, a natural question is ‘what are the chances of finding it with a sample of *x* many subjects?’ The usual way to approach this problem is to simulate data with a set of fixed parameter values, called the ‘true model’. These simulated data are then used as data to which a false model is fitted. The false model would normally be a submodel of the true model, for example with a parameter fixed to zero instead of the value used in the true world model. The size of the chi-squared from this false model, given the sample size, indicates the power of the test. The Power command uses this χ^2 and the user-supplied significance level α (*alpha*) and degrees of freedom (*df*) to compute the power of the study to reject the hypothesis. In addition, the program computes the total sample size that would be required, given the current proportion of subjects in each group, to reject the hypothesis at various power levels from .25 to .99. See page 108 for an example application of this method in the context of the classical twin study.

Confidence Intervals on Parameter Estimates

Syntax:

Interval {@val} <Matrix element list>

where val is the desired percentage of the confidence interval;

e.g., Interval @80 will give 80% confidence intervals (default is 95%)

This command requests confidence intervals on any matrix element. Usually one would request an element that is a free parameter, but it is also possible to request confidence intervals on computed matrices that are functions of free parameters. This allows confidence intervals on indirect effects in structural equation models to be computed. MX computes the upper and lower confidence intervals by conducting an optimization in n parameters for to find each interval. For long-running jobs involving many parameters or cpu-intensive fitting functions, optimizations to find confidence intervals on parameters will greatly increase the time taken to execute the job. Therefore, we recommend that Intervals be requested only when the script is thought to be working correctly.

The relative merits of likelihood-based confidence intervals versus standard errors based on asymptotic theory of the parameter have been discussed by Meeker and Escobar (1995) and Neale & Miller (1997). In brief, standard errors have the advantage of being fast to compute, but have several undesirable statistical properties. First, the distribution of the parameter estimate is assumed to be normal, whereas we have shown that it may not be (Neale & Miller, 1997). Second, t-statistics computed by dividing the estimate of a parameter by its standard error are not invariant to transformation (Neale et al., 1989; Kendall & Stuart, 1977). That is, if we estimate a^2 instead of a in a model, then a test of whether parameter a is significant will not give the same answer. For positive values of a the likelihood-ratio test that $a=0$ will give the same answer, regardless of whether the model was parameterized in terms of a or a^2 . Third, mindless use of the standard error can give nonsensical values if the parameter estimate is bounded. For example, a residual error variance may be theoretically bounded at zero, yet the standard error would imply less than zero as a lower bound on the estimate. With bounded parameters, MX will not report infeasible values for the likelihood-based confidence intervals, although it should be noted that confidence intervals that rest on parameter boundaries may not yield a decrease in fit corresponding to the required amount for the interval in question. Finally, the only major drawback to confidence intervals is the additional computation time required. As computers become faster and cheaper, this problem will diminish.

The procedure that MX uses to find confidence intervals is described in Neale & Miller (1997). The central idea is move a parameter as far away as possible from its estimate at the optimal solution (i.e., its maximum likelihood estimate (MLE) if the fit function is ML) for a given amount of increase in the fit function. For example, 95% confidence intervals are found by moving the parameter away from its MLE to a place where the fit function increases by 3.84 chi-squared units. Note that this moving away is done with all the other parameters in the model still free to vary. Obviously, stepping away from the MLE in small increments and re-optimizing would be very cpu-intensive, requiring m optimizations over $n-1$ parameters for an m step search on an n parameter model. Instead, MX uses a modified fitting function that is a function of the difference in fit between the MLE solution and the

new solution, and the value of the parameter. Essentially, the parameter (or matrix element) in question is minimized (lower bound) or maximized (upper bound) subject to the constraint that the fit of the model is a certain amount worse than at the maximum likelihood solution. As we know, optimization is not an exact science, and there can be problems in conducting the search to find the confidence intervals, just as optimization may not be successful when fitting a model. To combat this problem, MX uses two main strategies. First, if NPSOL returned an IFAIL of 4 (too few iterations) or 6 (Hessian accuracy problems) then it will repeat the optimization from the final point, up to a maximum of five times. Second, the user is notified of such difficulties with the Lfail and Ufail columns in the output. For example, output might be

```
Confidence intervals requested in group          3
Matrix Element Int.      Estimate      Lower      Upper  Lfail  Ufail
A  1  1  1  95.0          0.6196      0.5575      0.6879  0  0  0  0
C  1  1  1  95.0          0.0000      0.0000      0.0000  1  2  0  3
E  1  2  3  95.0          0.1735      0.1541      0.1961  0  0  6  5
```

In this case the attempts to find the CI's on A 1 1 1 appear successful. To find the lower CI on C 1 1 1, two refitting attempts were made, and the final solution received IFAIL=1 which is probably the right answer. For the upper CI on C 1 1 1, three refits were undertaken, and the solution was IFAIL=0, again probably the right answer. The lower CI on E 1 1 1, seems to be fine, but the upper one definitely shows signs of difficulty, with 5 attempts and still an IFAIL of 6. One would do well to check this upper confidence interval by removing the Interval commands and fixing the value of E 1 2 3 at .1961 to see whether the fit function deteriorated by 3.84 chi-squared units. It is easy to perform such a test for a free parameter in matrix element E 1 2 3, using the statement

```
Drop @.1961 E 1 2 3
just before the End of the last group.
```

It is more difficult to test the accuracy of the CI if the matrix is a computed matrix. In this case, one way to do it would be to add a constraint group to the job, like this:

```
Constraint group to fix E 1 1 1 at .1961
Constraint
Matrices = Group 1
  K full 1 1
  Z full 1 4
End Matrices;
Matrix K .1961
Matrix Z 2 3 2 3 ! to get the submatrix of E from element 2,3 to element 2,3
Constraint \part(E.Z) = K ;
End Group
```

Again, the decrease in fit due to this constraint should be examined by subtracting the χ^2 goodness of fit found in the unconstrained model from the fit found with the constraint in place. Should the difference not be approximately 3.84, one might wish to establish the confidence interval manually by trying different values than .1961 in Matrix K (or Drop).

Standard Errors

Syntax:

Option SErrors

This option is being phased out in favor of confidence intervals (see p. 90).

MX uses the numerical estimates of the hessian matrix of the parameters to provide approximate standard errors on the parameters. While it gives estimates consistent with those of other programs under a variety of conditions, this option is not reliable. Under these circumstances, standard errors may appear much too small. The same is true if the function precision is low (which may happen if, e.g., the fit function involves numerical estimation of integrals). The problem is sometimes overcome by altering the error function precision parameter, with `Option Err=value`. By default it is set close to machine accuracy; setting it to 1^{-10} (or larger) may correct problems with totally unrealistic estimates of standard errors.

!!

Standard errors do not work correctly when non-linear constraints are imposed with constraint groups.

Again, assessing significance and standard errors directly through changes in the model can provide more robust estimates. It is possible to get MX to doing this for you, but it requires some subtle programming (see example `conf.mx`). We hope to implement the method in a more user-friendly way soon.

Randomizing Starting Values

Syntax:

Option THard=n

where n is a positive integer

If the parameter THard is set using `TH=n` where n is a positive integer, MX will generate random starting values for all parameters and attempt to fit the model again. This attempt is likely to fail if no bounds are specified, because the default boundaries are -10000 and +10000, and the random values will be random from within these bounds. Most optimizers fail if starting values are too far away from the final solution; MX has shown greater tolerance than LISREL in this respect.

Testing Identification

THard can be very useful when exploring the identification of structural equation models. If data are generated with particular fixed values for the variable parameters (Θ_1), then optimization from a different set of starting values (Θ_2) should give a solution of the original values (Θ_1). This can be tested a number of times using THard. If sensible bounds are not given for the parameters, this test will likely fail because Θ_1 will not be recovered. The key to underidentification is finding a solution that fits perfectly, but with a parameter vector other than Θ_1 . If this is the case, the hypothesis that the model is identified has been *falsified*. Finding a number of solutions at Θ_1 does not prove identification of the model, it merely increases the support for the hypothesis that it is identified. Of course, this method

does not show that the model has been specified correctly; a completely misspecified model may be identified. See `Option` `check` below for another method.

Automatic Cold Restart

Syntax:

`Option THard=-n`

where n is a negative integer

During optimization, an estimate of the covariance matrix of the estimated parameters is constructed. Sometimes, this covariance matrix is inaccurate and optimization fails to converge to the correct solution, a problem that is usually flagged by an `IFAIL` parameter of `-6`. `Option TH=-n` can be used to restart the optimization `n` times from the current solution, but with the parameter covariance matrix reset to zero.

Jiggling Parameter Starting Values

Syntax:

`Option Jiggle`

Prior to optimization, parameter start values can be jiggled. Jiggling replaces each parameter start value x_i with $x_i + I(x_i + .5)$. This option can be useful to nudge MX away from a saddle point which can be troublesome when using numerically estimated derivatives. An example of a common saddle point is when parameters are started at or very near to zero, and the estimates x and $-x$ have the same effect on the function value. Such situations are common in structural equation models which feature quadratic forms in their expectations; the ACE genetic model is one such example.

When used in conjunction with a negative `THard` parameter, jiggling will occur each time the refit is attempted. This may cause estimates to drift from their initial values, especially if the parameter concerned has no effect on the fit function.

Confidence Intervals on Fit Statistics

Confidence intervals on the chi-squared statistic are obtained using a single parameter optimization method (Steiger and Lind, 1980). The $100(1-a)\%$ confidence limits for the noncentrality parameter λ of a χ^2 df, λ distribution are obtained by finding the values of λ that place the observed value of the Chi-square statistic at the $100(a/2)$ and $100(1-a/2)$ percentile points of a χ^2 df, λ distribution.

You can check the MX results with the useful link at

<http://www.stat.ucla.edu/calculators/cdf/ncchi2/ncchi2calc.phtml>

by entering the chi-sq and df and the p level (.95 or .05) to find the upper and lower bounds for 90% confidence intervals.

These confidence intervals on the chi-squared are used directly to compute the confidence intervals for the AIC and RMSEA statistics.

When fitting multiple models to the same data, it is common to want to know the difference in fit, the difference in degrees of freedom, and the probability associated with these differences. Option `Issat` specifies the current model as a model against which subsequent models fitted in the same run will be compared. This model does not have to be saturated, in the sense of having a free parameter for every observed statistic; it merely has to be a supermodel against which subsequent submodels will be compared. In addition, the fitting function being used should be asymptotically χ^2 distributed, or be a -2 log-likelihood. Most MX fit functions are of this type, but user-defined fit functions may not be.

Sometimes fitting a saturated model at the start of a sequence of analyses is computationally burdensome. As an alternative, the goodness-of-fit chi-squared and degrees of freedom of a supermodel may be directly entered using Option `SAT`. All subsequent models will be compared against this supermodel.

Check Identification of Model

Syntax:
Option `Check`

By default, MX does not test identification of models via examination of the rank of the hessian matrix of parameter estimates. Option `check` does this, but it should be noted that the results can give either false positives or false negatives. While this is to some extent true of programs that use exact derivatives, it is more true of MX which uses numerically estimated derivatives. When Option `check` is invoked, MX computes the eigenvalues and eigenvectors of the hessian matrix, and uses this information to assess potential areas of underidentification. As stated elsewhere - especially in Jöreskog's early papers - a better procedure is to attempt to find alternative sets of parameter estimates that give an equally good fit to the data (which is proof of underidentification). MX provides Option `TH=` to facilitate this proof. Identification should be tested on theoretical grounds whenever possible (see texts by Neale & Cardon (1992, p.104); Bollen (1992) and Pearl (1994) for discussion of these methods).

Changing Optimization Parameters

MX uses NPSOL, written by Walter Murray and Philip Gill at Stanford University, to perform numerical optimization in the presence of general linear, non-linear and boundary constraints. MX attempts to choose suitable values for the parameters that control optimization, taking into account the number of parameters to be estimated, the numerical precision of the function value, and so on. However, the enormous variety of types of optimization tasks that can in principle be requested with MX means that the automatic selection of these parameters is not always ideal. In addition, difficulties in optimization may require examination of the optional output that NPSOL can generate. MX allows the user to print these data and to alter the parameters as needed. There are also facilities for automatically performing some of the solutions of optimization difficulties suggested in the NPSOL manual (see also routine E04UCF in the NAG manual).

In general, parameters have been set for NPSOL on the cautious side, so that many of the

warning messages about IFAIL parameters being non-zero are spurious. This seems better than being misled by the program giving the wrong answer without warning.

- IFAIL=1 (code GREEN), most likely, the correct solution.
- IFAIL=4 (code BLUE - it ran out of breath), for which the Iterations=n may be used.
- IFAIL=3 (code RED - bad news) occurs in connection with constraints, normally they have been misspecified so that they are impossible to satisfy. Sometimes they are possible to satisfy but the starting values make it difficult for the optimizer to find a region where they are satisfied. IFAIL=3 can always be cured by making certain that the starting values satisfy all non-linear constraints, the command `Fix all` placed near the end of the script is useful in this regard.. Printing the residuals in the constraint groups often helps.
- IFAIL=6 (also code RED - take note) is the most tricky. Sometimes it occurs because of ill-conditioning of the Hessian, which can be verified by examination of the NAGDUMP output file (see page 96). A solution here may be to use the `TH=-n` which requests optimization from the current ‘solution’ with the Hessian reset to the identity matrix, `n` times. On other occasions, it may appear because of insufficient numerical precision, yet still be at the right place. If a parameter in your model is not identified, IFAIL=6 is quite likely.

Appropriate choice of starting values is always recommended. Many users start parameters at zero because this is the default value of free matrix elements. In practice, MX attempts to avoid so doing by starting any parameter in the range `-.01` to `.01` at `.01`. The user can assist this process with the `Jiggle` option to further nudge the parameter value away from a possible saddle point at zero (see page 93). But best of all is a reasonable guess at the parameter estimates that satisfies any non-linear constraints.

Setting Optimization Parameters

NAG=n, *Default: NAG=0*

If this statement appears on the `Options` line, the technical output from NPSOL is printed in a file called `NAGDUMP.OUT`. The value `n` controls the Major Print Level, the higher the number the more verbose the output file. Minimum output is written with `NAG=1` and maximum is written with `NAG=30`. MX prints the initial and final value of the function. If option `DB` is present (see below) more detailed information on the parameter estimates will be printed. MX rescales all functions to 1.0 to assist general optimization, so the function value printed by NPSOL is a proportion of this initial value.

Feasibility=n, *Default = .00001*

Will control the Nonlinear Feasibility Tolerance, i.e. `FEAS=r` defines “the maximum acceptable absolute violations in linear and nonlinear constraints at a ‘feasible’ point; i.e., a linear constraint is considered satisfied if its violation does not exceed `r`” (NAG, 1990). It has no effect if there are no nonlinear constraints.

Iterations=n, *Default = 100*

Controls the number of major iterations. Should be increased if IFAIL=4 error messages occur.

Linesearch=r, *Default = .9 if no non-linear constraints are present, otherwise, .3*
Linesearch tolerance.

Optimality=r, *Default = $1^{-(n+6)}$ where n is approximately $\ln(F_i)$ where F_i is the function value at the starting values*
Sets the optimality tolerance, a parameter controlling the accuracy of the solution.

Stepsize=r, *Default = 10000*
Infinite step size.

Function precision=r, *Default = $1^{-(n+8)}$ where n is approximately $\ln(F_i)$ where F_i is the function value at the starting values*
Specifies function precision. In general this should be set at a lower value than the required precision of the solution.

Obtaining Extensive Debug Output: DB=1

If the parameter DB=1 is set on the output line, together with NAG=n where n is greater than zero, additional information will be written to the NAGDUMP.OUT file. For each evaluation of the function to obtain the gradient of the parameter vector, the fit function value for each group, the total fit function, and the values of all the parameters are printed. On each evaluation of the function to obtain the constraint functions, the values of all the parameters and the constraint functions are printed. Note that the order of the parameters in the vector corresponds to the order used by NAG during optimization and not the order of parameter specifications given by the user, or printed by MX. Note also that using this option for problems with more than a few parameters can result in enormous NAGDUMP.OUT files. Examination of the first and last few iterations can be very helpful in identifying errant parameters whose extreme values may be causing floating point errors that make the program crash.

5.4 Fitting Submodels: Saving Matrices and Files

One of the powerful features of MX is its ability to start again where it left off. An example of this has already been described on pages 92 and 95 above, where repeated attempts to optimize are made either from the current solution or from randomized starting values. Here we describe how repeated fits may be made from the solution, allowing for changes in the model. This can be done manually, writing out matrices to files, or automatically within the same run, using the Multiple command, or from a saved binary file. For large problems, use of binary files can save a lot of time.

Fitting Submodels using Multiple Fit Option

Syntax:
Option Multiple

If the keyword Multiple is included on the Options line, the next MX input file is assumed to have a special form. It will consist of a single group, ending with an Options line. The only commands that may be used under the Multiple option are Specification, Pattern,

Matrix, Value, Start, Equate, Fix, Free and Options. Data may not be changed, matrices may not be added, and the matrix formulae specified in the Covariance or Means statement cannot be altered. At some time in the future, these restrictions may be lifted.

There is no group structure to the input stream following an Multiple command; all modifications to the model must refer to matrices with a number identifying the particular group in which the matrix is to be found. This changes the usual form of the Specification, Matrix and Pattern commands to include a group specification, which must be placed directly after the keyword, *before* the letter indicating the matrix. Thus

Specification A

becomes

Specification 2 A

if A was specified in group 2. As an example of the use of this command, consider the simple factor model presented on page 39. We could test the significance of the covariance of the two variables by fixing parameter #2 to zero. Obviously this could be achieved by modifying the entire input file and running it separately, but the following will fit both models in one run.

```
Simple MX example file
Data NGroups=1 NObservations=150 NInput_vars=2
CMatrix
  1.2 .8 1.3
Matrices
  A Full 2 1
  D Diag 2 2
Model A*A' + D /
Specification A 1 0
Specification D 0 3
Options Multiple RSiduals
End
  Specification 1 A 1 2
End
```



Considerable computer time can be saved using Multiple, since the solution of a model often has parameter estimates which are close to those estimated under nested models of the same type. In general, we recommend fitting models starting with the simplest, and working up to more complex models. When working from complex to simple, the Drop command (see next section) can be useful. If you have more than a single set of nested models to test, saving the general model in an MX binary save file (see page 99) can save considerable time and effort.

Multiple fit mode has always made revising the model and refitting from earlier solutions easy to do by changing the parameter contents and values of matrix elements. It is now possible to change matrix formulae and other characteristics of a group, using the #group 3 syntax. Options or matrix formulae supplied after this command would apply to group 3. For example, suppose that after fitting a model --- perhaps one that took days to run --- we might discover that we had accidentally forgotten to request residuals from group 5. If, in anticipation of this or similar errors, we had issued a save command:

```

< usual model commands >
Option Multiple
End      !<- end statement of last group

Save incase.mxs
End

```

It would be possible to retrieve the solution, add the appropriate option, and re-run:

```

Title - revise options to see residuals
Get incase.mxs
#group 5
Option RSiduals
End

```

This type of strategy may be useful to obtain additional fit-statistics for null-model comparisons.

Dropping Parameters from Model

Syntax:

```
Drop {@value} <parnumlist><elementlist>
```

where <parnumlist> is a list of parameter numbers as used in the Specification command, and @value is an optional value to fix at, and Matrix element list is a list of matrix elements

Quite often, equality constraints between parameters lead to model specifications with the same parameter in many different matrices or several groups or both. Fixing all occurrences of the parameter with the Fix parameter can be time-consuming and error prone, so the Drop command may be used instead. By default, all parameters whose specification number matches a number in the list following the Drop command will be fixed to zero. For example:

```

Drop 5 8 7
Drop 11 to 20
Drop X 2 1 3

```

would fix to zero all occurrences of parameters 5, 8, 7, 11 through 20 and all occurrence of whichever parameter is specified in element X 2 1 3. Note that matrix addresses cannot be used in this command. It is possible to supply an optional value to the drop command, so that for example

```
Drop @.5 2 3
```

would fix all occurrences of parameters 2 and 3 to 0.5.

Reading and Writing Binary Files

Syntax:

```

Save <filename>
Get <filename>

```

where <filename> is the name of the file to be saved or retrieved - the extension .mxs is recommended

When the multiple fit option is implemented (see page 97) the entire input job specifications, data, and estimates may be stored in binary format for rapid retrieval and estimation in subsequent fitting of submodels. Note that *Save* *must* follow the entire job specification. Thus for example the following would save the results of fitting the model, together with the complete model specification, in the file `acesave.mxs`:

```
...
! Mx commands for first job precede this line
Option Multiple
End
Save acesave.mxs
! First command in multiple fit number 1
Fix all
End
```

The `Fix ALL` command simply stops the optimizer from trying to improve on the current solution by fixing all the parameters. To use this binary save file in another command file, we could use the following:

```
Title - using a binary file
Get acesave.mxs
Free A 1 2 3
End
```

By retrieving a binary file, MX is automatically in the Multiple fit mode, so modifications can be made to the model and a further series of hypotheses tested. If `Get` is used in a separate job, a title line is required before this statement. Normally, parameter estimates after model fitting are stored, but if it is desired to save the user's starting values, it is possible to set the number of iterations to zero, use `Multiple`, and `Save` the starting values.

Writing Matrices to Files

Syntax:

```
MXa= <filename>
```

where *a* is the single-letter name of the matrix to be written, or one of %E %M %P %V

MX will write matrices to files with this command. The first line has header information, including the group number, the matrix name, type and dimensions. The matrix elements are then written in FORTRAN format (6D13.6). This file format is fully compatible with LISREL, so matrices output by MX can be read in as starting values for LISREL and *vice versa* (see page 71). If the matrix name is %E, the expected covariance matrix will be written to the file. If the matrix name is %M, the expected mean matrix will be written to a file. For groups with raw maximum likelihood fit functions, %P will write a series of columns of information about the likelihood of individual pedigrees (see page 101). Finally, it is also possible to save a VL file, with the %V keyword. While this is not normally useful (since it would recreate the original data file), following the `select` command it can be advantageous. Subsequent reading of the selected data can be faster than reading the whole dataset and performing selection again.

Formatting and Appending Matrices Written to Files

Syntax:

Option Append

Option Format=(F)

where F is a legal FORTRAN format

The default 6D13.6 format used by MX to write matrices to files may be changed with Option FORMAT. It is best to consult a FORTRAN language reference manual for full details on legal formats. In brief, the general form for numbers is Fw.d where F indicates floating point, w is total width, and d is the number of digits after the decimal point. A comma delimited list of formats may be provided. Spaces may be inserted with the syntax nx where n is the number of spaces provided, and parentheses may be used to repeat format specifiers. For example, 6(F5.2,2x) would be used to write numbers in 5 spaces with 2 decimal places, and followed by 2 spaces. After writing 6 such numbers, a new line would be used to write subsequent numbers.

Option Append causes all matrices to be appended to existing files of the same name, if they exist. The format is only written once, if the file does not previously exist.

Writing Individual Likelihood Statistics to Files

Syntax:

MX%P= <filename>

A valuable feature for identifying outliers and possible heterogeneity in raw data is to save the individual likelihood statistics to a file. These data may subsequently be inspected with other software to produce half-normal plots and the like. The syntax for this follows the writing of a matrix to a file, but we separate it because of the complexity of the output. For each vector in the rectangular or V. data file, MX outputs eight columns of data:

1. $-2\ln L$ the likelihood function for that vector of observations
2. the square root of the Mahalanobis distance, $Q = (x-\mu)' \Sigma^{-1} (x-\mu)$
3. a estimated z-score $Z = ((Q/n_i)^{1/3} - 1 + 2/(9n_i)) (9n_i/2)^{.5}$ where n_i is the number of individuals in the ith data vector
4. the number of the observation in the active (i.e. post selection) dataset. Note that with selection this may not correspond to the position of the vector in the data file
5. the number of data points in the vector (i.e. the family size if it is a pedigree with one variable per family member)
6. the number of times the log-likelihood was found to be incalculable during optimization
7. 000 if the likelihood was able to be evaluated at the solution, or 999 if it was incalculable
8. the model number if there are multiple models requested with the NModel argument to the Data line

Results from all raw data groups are written to the same file (the beginning of another group's information can be seen from a change in the case number). The third item in the

list is especially useful for detecting outliers when there are missing data, being relatively independent of the number of data points in the vector in question (Johnson & Kotz, 1970; Hopper & Mathews, 1982). Of two formulae for computing the z-score (the other being $Z_2 = (2Q_i)^5 - (2n_i - 1)$) we found Z to be much closer to a normal distribution. Half-normal plot of this statistic should (for multivariate normal data) show a close fit of each data point to its expected value.

Another valuable role for this output is to pinpoint particularly nasty outliers that prevent optimization from succeeding, usually causing an IFAIL=-1 problem. Searching through the saved individual likelihood file for the string '999 ' (note the leading and trailing blanks) will find cases where the likelihood could not be evaluated for the particular set of parameter estimates in use.

Creating RAMpath Graphics Files

Syntax:

Draw= <filename>

Structural equation models may be specified very simply in terms of three matrices. The first matrix **S**, is symmetric and specifies all the two-headed arrows between all the variables (both latent and observed) in the diagram. The second matrix **A**, is asymmetric and specifies all the single-headed arrows between all the variables in the model. Causal paths from variable i to variable j are specified in element A_{ji} . For example, a path from variable 1 to variable 4 would be represented in element (4,1) of this matrix. The third matrix **F**, is used to filter the observed variables from the latent variables for the purpose of model fitting. The development and application of this approach is succinctly described in the RAMpath manual (McArdle & Boker, 1990).

Iff⁹ you specify a model with these three matrices, F, A and S, then RAMpath graphics files may be written and saved to a file with the Draw command. This file, largely consisting of a RAMpath input_model command, may be used as input for RAMpath to draw a diagram of your model to view or to produce publication-quality output on a postscript printer. Conversely, the command save_mx in RAMpath will generate an MX script. The MX graphical interface, currently in alpha-test, provides an alternative to using RAMpath.

⁹ Iff with two f's means 'if and only if'

6 Example Scripts

What you will find in this chapter

- Example scripts
- Brief description of the models and methods being used

There are very many different ways of setting up any particular model in MX. As with any programming, there is a compromise between compactness and comprehensibility that is set by the individual user. The most compact files are often the least comprehensible; the longest ones may be prone to typographical errors, and can be very boring to check. Judicious use of comments can make for a brief but comprehensible input file.

6.1 Using Calculation Groups

The examples in this section do not fit models; matrix formulae are simply evaluated and the results are printed.

General Matrix Algebra

Suppose we wish to find the inverse of the symmetric matrix:

$$\begin{bmatrix} 1. & & \\ .23 & 2. & \\ .34 & .45 & 3. \end{bmatrix}$$

The following input file could be created:

```
Title: Inverting Symmetric 3 x 3 example file
Calculation NGroups=1
Begin Matrices;
  A Symm 3 3
End Matrices;
Matrix A
  1.
  .23 2
  .34 .45 3.
Begin Algebra;
  B= A~;
End Algebra;
Options MxB=inverted.mat
End
```

The output matrix `inverted.mat` contains the nine elements of the matrix **B**, which is the inverse of **A**.

Assortative Mating 'D' Matrix

Multivariate phenotypic assortative mating (Van Eerdewegh, 1982; Vogler, 1985; Carey, 1986 Phillips et al., 1988; Fulker, 1988) leads to a predicted covariance matrix between husbands' and wives' phenotypes of the form:

$$\Sigma = \begin{bmatrix} \mathbf{R}_H & \mathbf{R}_H \mathbf{D}' \mathbf{R}_W \\ \mathbf{R}_W \mathbf{D} \mathbf{R}_H & \mathbf{R}_W \end{bmatrix}$$

Thus the matrix \mathbf{D} can be obtained from $\mathbf{R}_W^{-1} \mathbf{M} \mathbf{R}_H^{-1}$, where $\mathbf{M} = \mathbf{R}_W \mathbf{D} \mathbf{R}_H$, the off-diagonal block of correlations between phenotypes of husbands and phenotypes of wives. The following MX input file will calculate matrix \mathbf{D} .

```
#define nvar 3
Calculation of full D matrix, 3 phenotypes husband & wife
Calculation NGroups=1
Begin Matrices;
  A Symm nvar nvar    ! Covariance of wives' variables
  B Symm nvar nvar    ! Covariance of husbands' variables
  C Full nvar nvar    ! Covariance between husband & wife variables
End Matrices;
Matrix A
1
.4 .9
.3 .5 1.1
Matrix B
1.2
.42 1.
.3 .47 .9
Matrix C
.4 .1 .2
.05 .3 .12
.22 .11 .5
Begin Algebra;
  D= A~*C*B~ ;
End Algebra;
End
```

The relevant part of the output file looks like this:

```
CALCULATION OF FULL D MATRIX, 3 PHENOTYPES HUSBAND & WIFE
Matrix A
1.0000
0.4000 0.9000
0.3000 0.5000 1.1000
Matrix B
1.2000
0.4200 1.0000
0.3000 0.4700 0.9000
```

```

Matrix C
  0.4000    0.1000    0.2000
  0.0500    0.3000    0.1200
  0.2200    0.1100    0.5000
Matrix D
  0.4302   -0.2854    0.1497
 -0.3471    0.7770   -0.5237
  0.1361   -0.4908    0.7829

```

Pearson-Aitken Selection Formula

This example is a little more complex. In 1934, Aitken generalized Pearson's formulae for predicting the new mean and variance of variable when selection is performed on a correlated variable. Aitken's delightful paper shows how selection on a vector of variables, X_S , leads to changes in the covariance of correlated variables X_N that are not themselves selected. If the original (pre-selection) covariance matrix of X_S is \mathbf{A} , and the original covariance matrix of X_N is \mathbf{C} , and the covariance between X_N and X_S is \mathbf{B} , then the original matrix may be written

$$\left[\begin{array}{c|c} \mathbf{A} & \mathbf{B} \\ \hline \mathbf{B}' & \mathbf{C} \end{array} \right]$$

if selection transforms \mathbf{A} to \mathbf{D} , the whole new matrix is given by:

$$\left[\begin{array}{c|c} \mathbf{D} & \mathbf{DA}^{-1}\mathbf{B} \\ \hline \mathbf{B}'\mathbf{A}^{-1}\mathbf{D} & \mathbf{C} - \mathbf{B}'(\mathbf{A}^{-1} - \mathbf{A}^{-1}\mathbf{D}\mathbf{A}^{-1})\mathbf{B} \end{array} \right]$$

Likewise, if the original means are $(x_s : x_n)'$ and selection modifies x_s to \tilde{x}_s , the vector of means after selection is given by:

$$x_n + \mathbf{A}^{-1}\mathbf{B}(x_s - \tilde{x}_s)$$

where $(x_s - \tilde{x}_s)$ is the deviation of the means of the selected variables from their original values.

```

#Ngroups 1
Pearson Aitken Selection formulae
! Idea is to give original means and covariances, and get new ones
Calc
Begin Matrices;
  A Symm 2 2  ! Original covariances of selected vars
  B Full 2 2  ! Original covariances of selected and not-selected vars
  C Symm 2 2  ! Original covariances of non-selected vars
  D Symm 2 2  ! Changed A after selection
  S Full 2 1  ! New means of selected vars (assume initially zero)
  N Full 2 1  ! Original means of not-selected vars
End Matrices;

```

```

Matrix A 1. .7 1.
Matrix B .6 .42 .42 .6
Matrix C 1. .352 1.
Matrix D 1. .4 1.
Matrix N 3 4
Matrix S 2 1
Begin Algebra;
V=      D|                D*A~*B_ ! Note that underscore above is UNDER operator
      B'*A~*D| C-B'*(A~-A~*D*A~)*B ; ! not A with a horizontal bar over it
M= N + A~*B*S ;
End Algebra;
End

```

The new covariance matrix and mean vector are printed as the matrices **V** and **M**.

6.2 Model Fitting with Genetically Informative Data

The examples in this section demonstrate elementary use of MX to fit models to data in the form of variance-covariance matrices.

ACE Genetic Model for Twin Data

If data are collected from identical or monozygotic (MZ) twins and from fraternal or dizygotic (DZ) twins, it is possible to estimate parameters of a model that includes the effects of additive genes (**A**), shared or family environment (**C**) and random or unique environment (**E**). This model is shown in Figure 6.1 as a path diagram.

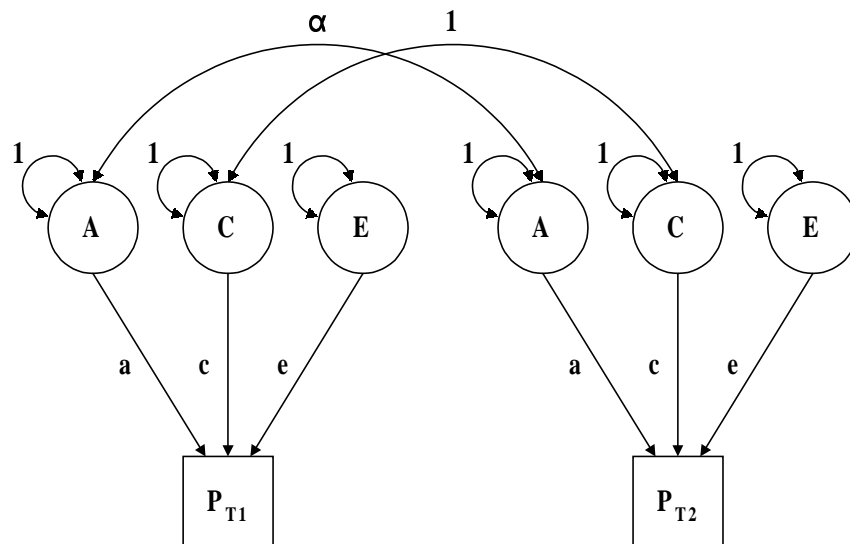

Figure 6.1 ACE genetic model for twin data. Path model for additive genetic (A), shared environment (C) and specific environment (E) effects on phenotypes (P) of pairs of twins (T1 and T2). The parameter α is fixed at 1 for MZ twins and at .5 for DZ twins. All latent variables have a variance of 1.0.

The approach used here generalizes to the multivariate case, by increasing `nvar` and `twonvar` and the datafiles. Heath et al. (1989) allow for phenotypic interaction, but this is left for a later example (p. 114)

```
#Ngroups 3
#define nvar 1          ! number of variables
#define twonvar 2      ! two times nvar
! A C E model fitted to the Heath et al (1989) data on alcohol consumption
G1: model parameters
  Calc
  Begin Matrices;
    X Lower nvar nvar Free ! genetic structure
    Y Lower nvar nvar Free ! common environmental structure
    Z Lower nvar nvar Free ! specific environmental structure
    W Lower nvar nvar Fixed ! dominance structure
    H Full 1 1
    Q Full 1 1
  End Matrices;
  Matrix H .5
  Matrix Q .25
  Begin Algebra;
    A= X*X' ;
    C= Y*Y' ;
    E= Z*Z' ;
    D= W*W' ;
  End Algebra;
End

G2: Monozygotic twin pairs
Data NInput-vars=twonvar NObservations=171
Labels Alc_t1 Alc_t2
CMatrix
  1.28  0.766 1.194
Matrices= Group 1
Covariances A+C+D+E | A+C+D _
              A+C+D  | A+C+D+E /
Options RSiduals
End

G3: Dizygotic twin pairs
Data NInput_vars=twonvar NObservations=101
Labels Alc_t1 Alc_t2
CMatrix
  1.077 0.463 0.962
Matrices= Group 1
Covariances A+C+D+E | H@A+C+Q@D _
              H@A+C+Q@D | A+C+D+E /
Start .6 All
Options Multiple RSiduals
End
```

Power Calculation for the Classical Twin Study

Our next example uses the same model as in the preceding section, but in this case we calculate the power of the classical twin study to detect the effects of common environmental variation. The particular case we wish to examine is where the true population variance comprises 20% additive genetic, 30% shared environment, and 50% random environment variance, but we fit a model *without* shared environment variation to simulated MZ and DZ covariance matrices. This example is discussed in some detail in Neale & Cardon (1992); here we reproduce their results with a simple script.

There are two stages to the power calculation. First, fixed values of the parameters a , c and e are given, and a two-group MX script simply calculates the expected covariances under the model, and saves them to two files, mzsim.cov and dzsim.cov. The next problem (preferably in the same input file, though this isn't essential) fits a model of additive genetic and random environmental variance only. The complete input file looks like this:

```
! A C E model for power calculation

#Ngroups 3
! Step 1: Simulate the data
!   30% additive genetic (.54772=.3)
!   20% common environment (.44722=.2)
!   50% random environment (.70712=.5)
G1: model parameters
  Calc
  Begin Matrices;
    X Lower 1 1 Fixed ! genetic structure
    Y Lower 1 1 Fixed ! common environmental structure
    Z Lower 1 1 Fixed ! specific environmental structure
    H Full 1 1
  End Matrices;
  Matrix X .5477
  Matrix Y .4472
  Matrix Z .7071
  Matrix H .5
  Begin Algebra;
    A= X*X' ;
    C= Y*Y' ;
    E= Z*Z' ;
  End Algebra;
  End

G2: MZ twin pairs
  Calc NInput_vars=2
  Matrices= Group 1
  Covariances A+C+E | A+C _
               A+C   | A+C+E /
  Options MX%E=mzsim.cov
  End
```

```

G3: DZ twin pairs
  Calc NInput_vars=2
  Matrices= Group 1
  Covariances A+C+E | H@A+C _
                H@A+C | A+C+E /
  Options MX%E=dzsim.cov
End

!
! -----
! Step 2: Fit the wrong model to the simulated data
#Ngroups 3
G1: model parameters
  Calc
  Begin Matrices:
    X Lower 1 1 Free    ! genetic structure
    Y Lower 1 1 Fixed  ! common environmental structure
    Z Lower 1 1 Free    ! specific environmental structure
    H Full 1 1
  End Matrices;
  Matrix H .5
  Begin Algebra;
    A= X*X' ;
    C= Y*Y' ;
    E= Z*Z' ;
  End Algebra;
End

G2: MZ twin pairs
  Data NInput_vars=2 NObservations=1000
  CMatrix Full File=mzsim.cov
  Matrices= Group 1
  Covariances A+C+E | A+C _
                A+C  | A+C+E /
  Option RSiduals
End

G3: DZ twin pairs
  Data NInput_vars=2 NObservations=1000
  CMatrix Full File=dzsim.cov
  Matrices= Group 1
  Covariances A+C+E | H@A+C _
                H@A+C | A+C+E /
  Start .5 All
  Options RSiduals Power= .05,1    ! .05 sig level & 1 df
End

```

The relevant part of the output is at the end, where we see that for the specified sample sizes of 1000 pairs each of MZ and DZ twins, the χ^2 goodness-of-fit is 11.35, as found by Neale & Cardon (1992):

```
Chi-squared fit of model = 11.349
Degrees of freedom = 4
Probability = 0.023
Akaike's Information Criterion = 3.349
```

Power of this test, at the 0.0500 significance level with 1. df is 0.920572
 Based on your combined observed sample size of 2000.
 The following sample sizes would be required to reject the hypothesis:

Power	Total N
.25	290.
.50	677.
.75	1223.
.80	1383.
.90	1852.
.95	2290.
.99	3238.

Because we requested that this statistic be treated as a χ^2 for 1 degree of freedom for the purposes of calculating power at the .05 level of significance (Power=.05, 1), the output gives the power of the test given the particular sample sizes (and MZ:DZ sample size proportions), followed by the sample sizes that would be required to obtain certain commonly used levels of power. The power is quite high (.92) with 2000 pairs. The required sample sizes to reach certain power levels from .25 to .99 are also shown.

RAM Specification of Model for Twin Data: Graphics Output

Here is a two group example, a phenotypic interaction PACE model (see page 114 for more details), specified using the three matrix approach of McArdle & Boker (1990). Details of this method, and the syntax of the Draw command can be found on page 102.

The title for the diagram is taken from the title of the group in the MX input file, and the labels for the variable are taken from labels of the columns of the **S** matrix. The draw commands in this file produce two files, mx.ram and dz.ram. I don't like the way RAMpath draws interaction between the phenotypes, but there is a certain irrefutable logic in having causal arrows always going out the bottom of a variable and in the top. You can easily edit the RAMpath file to get rid of the @ signs if you like. Note that specifying models à la RAMpath is didactically very clear but computationally inefficient, since the inverse of the maximally dimensioned **A** matrix is required.

```
! Phenotypic interaction PACE model, Heath 1989
! Demonstration of RAM specification and output
Group 1: MZ twins
Data NGroups=2 NInput_vars=2 NObservations=171
CMatrix Symm File=alcmz.cov
Matrices
S Symm 8 8
I Iden 8 8
A Full 8 8
F ZIden 2 8
```

```

End Matrices;
Matrix S
1
0 1
0 0 1
1 0 0 1
0 1 0 0 1
0 0 0 0 0 1
0 0 0 0 0 0 0
0 0 0 0 0 0 0 0
Label row a a1 c1 e1 a2 c2 e2 p1 p2
Label col a a1 c1 e1 a2 c2 e2 p1 p2
Label row s a1 c1 e1 a2 c2 e2 p1 p2
Label col s a1 c1 e1 a2 c2 e2 p1 p2
Specify A
0 0 0 0 0 0 0 0 0
0 0 0 0 0 0 0 0 0
0 0 0 0 0 0 0 0 0
0 0 0 0 0 0 0 0 0
0 0 0 0 0 0 0 0 0
0 0 0 0 0 0 0 0 0
1 2 3 0 0 0 0 4      ! This is where the parameters are
0 0 0 1 2 3 4 0
Start .6 A 7 1 A 7 3
Covariances F*(I-A)~*S*(I-A)~'*F'/
Options RSiduals Draw=mz.ram
End

Group 2: DZ twins
Data NInput_vars=2 NObservations=101
CMatrix Symm File=alcdz.cov
Matrices
S Symm 8 8
I Iden 8 8
A Full 8 8 = A1
F ZIden 2 8
Matrix S
1
0 1
0 0 1
.5 0 0 1
0 1 0 0 1
0 0 0 0 0 1
0 0 0 0 0 0 0
0 0 0 0 0 0 0 0
Bound -.99 .99 3
Bound 0 5 1 2
Covariances F*(I-A)~*S*(I-A)~'*F'/
Options RSiduals Draw=dz.ram
End

```

Cholesky Decomposition for Multivariate Twin Data

Any positive definite matrix may be transformed to a product of a lower triangular matrix and its transpose, i.e.

$$\Sigma = \mathbf{LL}'$$

This *Cholesky* decomposition is unique for a given positive definite matrix Σ , except for transformations of sign obtained by multiplying by diagonal matrices with elements set to -1 or 1. It has a simple graphic representation as a path diagram (Figure 6.2) where the first latent factor loads on all variables, the second on all variables except the first, the third on all variables except the first two, and so on.

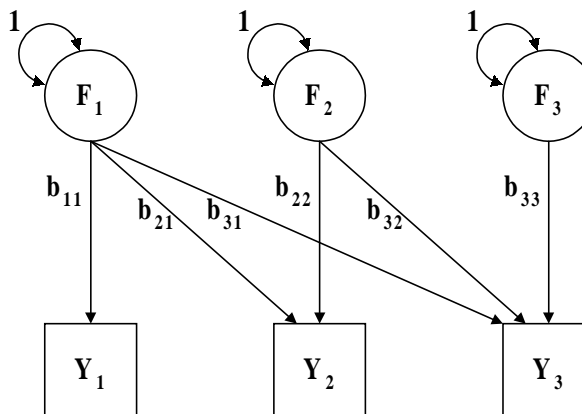

Figure 6.2 Cholesky or triangular factor model for three variables Y_1 , Y_2 and Y_3

In multivariate genetic analysis, a Cholesky (triangular) decomposition of separate genetic and environmental covariance matrices is possible. Thus the additive genetic, shared environment and random environment factors in the simple ACE model (Figure 6.1) have a multivariate counterpart where the phenotypes P_{T1} and P_{T2} are replaced by vectors of observed phenotypes, and the latent variables \mathbf{A} , \mathbf{C} and \mathbf{E} are replaced by vectors of factors. The path coefficients \mathbf{a} and \mathbf{e} are replaced by triangular matrices of factor loadings according to the Cholesky decomposition. Our aim is to produce a script that is very easy to modify when the number of variables analyzed changes.

Here we use an input file that calculates the genetic, shared and random environmental factors in the first group that generates genetic, shared and random environment covariance matrices. It is then a simple matter to form the expected covariance matrices for twin data as partitioned matrices containing linear combinations of these matrices. It is then simplicity itself to fix a parameter to zero, as only one character has to be changed from a 1 to a 0. The example includes data from individuals without cotwins (group 2), as well as MZ (group 3) and DZ (group 4) twin pairs. Estimates from a model such as this depend on the size of the observed variances, and can be difficult to interpret. Estimates of the proportion of variance and covariance due to each source can be obtained using the element division operator (%) (group 5).

```

! Trivariate Cholesky 'Independent Pathways' model
! Data are Extraversion, Neuroticism and CESD Depression
#Ngroups=5
#Define nvar 3
#Define twonvar 6
#Define nunmatched 449
#Define nMZ 456
#Define nDZ 357

G1: model parameters
  Calculation NGroups=5
  Begin Matrices;
    X Lower nvar nvar Free    ! genetic structure
    Y Lower nvar nvar Free    ! common environmental structure
    Z Lower nvar nvar Free    ! specific environmental structure
    H Full 1 1
  End Matrices;
  Matrix H .5
  Start .6 All
  Begin Algebra;
    A= X*X' ;
    C= Y*Y' ;
    E= Z*Z' ;
  End Algebra;
End

! Now get to the actual data, and use the results of calculations
G2: Unmatched twins
  Data NInput_vars=nvar NObservations=nunmatched
  CMatrix Symm File=endun.cov
  Matrices= Group 1
  Covariances A+C+E /
  Option RSiduals
End

G3: MZ twins with cotwins
  Data NInput_vars=twonvar NObservations=nMZ
  CMatrix File=endmz.cov
  Matrices= Group 1
  Covariances A+C+E | A+C _
                  A+C | A+C+E /
  Option RSiduals
End

G4: DZ twins with cotwins
  Data NInput_vars=twonvar NObservations=nDZ
  CMatrix File=enddz.cov
  Matrices= Group 1
  Covariances A+C+E | H@A+C _
                  H@A+C | A+C+E /

```

```

! By using the Kron operator every element of G is multiplied by .5
Option RSiduals
End

G5: Calculation of standardized solution
Calculation
Matrices= Group 1
I Iden nvar nvar
Begin Algebra;
P= A+C+E;
G= \sqrt(I.P)*A;
K= \sqrt(I.P)*C;
L= \sqrt(I.P)*E;
End Algebra;
Option RSiduals
End

```

PACE Model: Reciprocal Interaction between Twins

Figure 6.3 shows a path diagram similar to the ACE model for twin data. There is now a path (I) from the phenotype of a twin to that of his or her cotwin. This is reciprocal interaction between dependent variables. It can easily be shown (see appendix D) that a matrix representation of this process is to use the formulation $(\mathbf{I} - \mathbf{B})^{-1}$, where \mathbf{B} is a matrix whose element b_{jk} represents the causal effects of variable k on variable j . In this case, the parameter I has been bounded to lie between -1 and 1 , though this is not necessary.

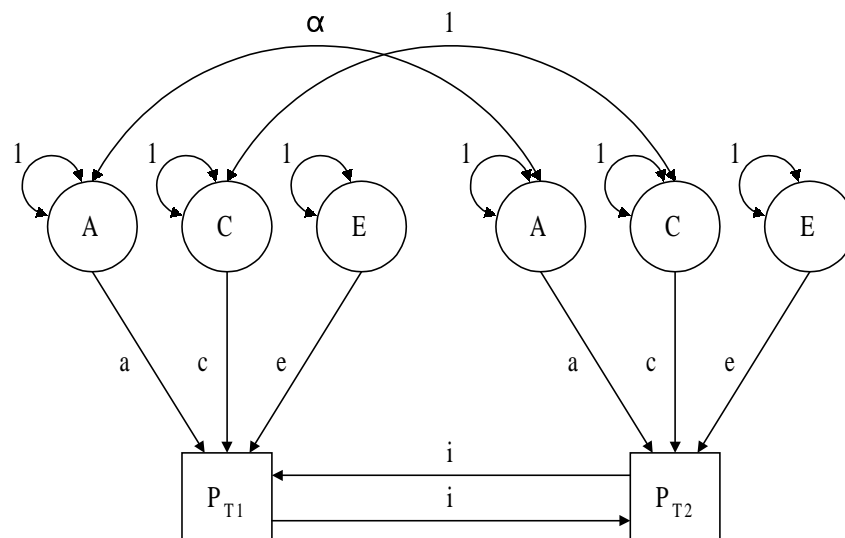

Figure 6.3 PACE model for phenotypic interaction between twins. Path for additive genetic (A), shared environment (C) and specific environment (E) effects on phenotypes (P) of pairs of twins (T1 and T2). Path i models direct phenotypic effects of a twin on his or her cotwin. The parameter α is fixed at 1 for MZ twins and at .5 for DZ twins.

```

!Phenotypic interaction model, fit to Heath 1989 data.
#Ngroups 3
G1: model parameters
  Calc
  Begin Matrices;
    X Diag 1 1 Free      ! genetic structure
    Y Diag 1 1 Free      ! common environmental structure
    Z Diag 1 1 Free      ! specific environmental structure
    P Full 2 2           ! interaction parameters
    I Iden 2 2
    H Full 1 1
  End Matrices;
  Specify P
    0 4
    4 0
  Matrix H .5
  Start .6 All
  Bound -.99 .99 4
  Bound 0 5 1 2 3
  Begin Algebra;
    A= X*X' ;
    C= Y*Y' ;
    E= Z*Z' ;
    B=(I-P)~;
  End Algebra;
End

G2: female MZ twin pairs
  Data NInput_vars=2 NObservations=171
  Labels alc_t1 alc_t2
  CMatrix Symmetric File=alcmz.cov
  Matrices= Group 1
  Covariances B &(A+C+E | A+C _
                A+C | A+C+E) /
  Option RSiduals
End

G3: female DZ twin pairs
  Data NInput_vars=2 NObservations=101
  Labels alc_t1 alc_t2
  CMatrix Symmetric File=alcdz.cov
  Matrices= Group 1
  Covariances B &(A+C+E | H@A+C _
                H@A+C | A+C+E) /
  Option RSiduals
  Options NDecimals=4
End

```

Scalar, Non-scalar Sex Limitation and Age Regression

The model and data in this section were taken from Neale & Martin (1989) who fitted a model of scalar sex-limitation to data from 5 groups of twins who reported subjective impressions of drunkenness following a challenge dose of alcohol. The model here involves additive genetic, shared and random environment components (**A**, **C** and **E**; see example on page 106, and Figure 6.1, but allows these to differ in their effects on the phenotypes of males and females. In addition, the regression of the phenotypes on Age is modeled, so that there are parameters for the variance of age (σ_a^2) and for the regressions (s). A path diagram of the model is shown in Figure 6.4.

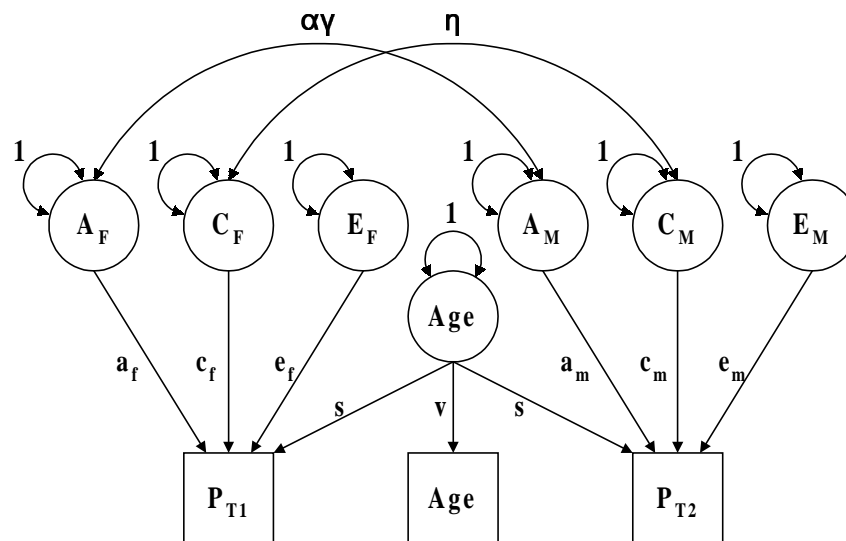

Figure 6.4 Model for sex limitation and age regression. Sex-limited additive genetic (A), shared environment (C) and specific environment (E) effects on phenotypes (P) of pairs of twins (T1 and T2). The parameter α is fixed at 1 for MZ twins and at .5 for DZ twins. Either γ or η may be estimated with data from twins, but not both.

Note the use of boundary constraints to prevent the estimation of parameters of opposite sign in the two sexes.

```
! Age correction
! Sex limitation model
#Ngroups 7
G1: female model parameters
Calculation
Begin Matrices;
  X Lower 1 1 Free    ! genetic structure
  Y Lower 1 1 Free    ! common environmental structure
  Z Lower 1 1 Free    ! specific environmental structure
  S Lower 1 1 Free    ! effect of age on phenotype
  V Lower 1 1 Free    ! variance of age
  H Full 1 1
```

```

End Matrices;
Matrix H .5
Begin Algebra;
A= X*X' ;
C= Y*Y' ;
E= Z*Z' ;
G= S*S' ;
End Algebra;
End

```

G2: male model parameters

```

Calculation
Begin Matrices;
X Lower 1 1 Free ! genetic structure
Y Lower 1 1 Free ! common environmental structure
Z Lower 1 1 Free ! specific environmental structure
S Lower 1 1 Free ! effect of age on phenotype
V Lower 1 1 Free ! variance of age
H Full 1 1 =H1
Begin Algebra;
A= X*X' ;
C= Y*Y' ;
E= Z*Z' ;
G= S*S' ;
End Algebra;
End

```

G3: Female MZ twin pairs

```

Data NInput_vars=3 NObservations=43
CMatrix Symmetric File=drunkmzf.cov
Labels age drunkt1 drunkt2
Matrices= Group 1
Covariances V*V | S*V | S*V _
              S*V | A+C+E+G | A+C+G _
              S*V | A+C+G | A+C+E+G /
Option RSiduals
End

```

G4: Female DZ twin pairs

```

Data NInput_vars=3 NObservations=44
CMatrix Symmetric File=drunkdzf.cov
Labels age drunkt1 drunkt2
Matrices= Group 1
Covariances V*V | S*V | S*V _
              S*V | A+C+E+G | H@A+C+G _
              S*V | H@A+C+G | A+C+E+G /
Option RSiduals
End

```

```

G5: Male MZ twin pairs
Data NInput_vars=3 NObservations=42
CMatrix Symmetric File=drunkmzm.cov
Labels age drunkt1 drunkt2
Matrices= Group 2
Covariances V*V | S*V | S*V _
              S*V | A+C+E+G | A+C+G _
              S*V | A+C+G | A+C+E+G /
Option RSiduals
End

G6: Male DZ twin pairs
Data NInput_vars=3 NObservations=38
CMatrix Symmetric File=drunkdzm.cov
Labels age drunkt1 drunkt2
Matrices= Group 2
Covariances V*V | S*V | S*V _
              S*V | A+C+E+G | H@A+C+G _
              S*V | H@A+C+G | A+C+E+G /
Option RSiduals
End

G7: Female-Male DZ twin pairs
Data NInput_vars=3 NObservations=39
CMatrix Symmetric File=drunkdzo.cov
Labels age drunkt1 drunkt2
Matrices= Group 1
Y Computed 1 1 = G1
J Computed 1 1 = A2
K Computed 1 1 = C2
L Computed 1 1 = E2
X Computed 1 1 = G2
T Lower 1 1 = S2
W Lower 1 1 = V2
Covariances
V*W | S*V | T*W _
S*V | A+C+E+Y | H@(\sqrt(A*J))+Q@(\sqrt(C*K))+(\sqrt(Y*X)) _
T*W | H@(\sqrt(A*J))+Q@(\sqrt(C*K))+(\sqrt(Y*X)) | J+K+L+X /
Start .5 All
Start 10 V 1 1 1 V 2 1 1
Bound 0 5 1 2 3 6 7 8
Option RSiduals
End

```

Multivariate Assortative Mating: Modeling \mathbf{D}

In this section we return to the transformation of the data described on page 104. The question is now, how do we fit a model with parameters in the \mathbf{D} matrix, so that we can explore the significance of marital assortment both within and between variables. For example, is there selection of wealthy men by attractive women, or is it just that attractiveness and wealth are correlated, and partners choose each other on the grounds of wealth alone? Neale & McArdle (1990) published a transformation of the matrix equation on page 104 which allowed the fitting of LISREL and COSAN models to marital data. The LISREL implementation of the model is not straightforward, involving phantom latent variables (Rindskopf, 1984). However, the model is very easy to implement in MX, as is shown below. We have already shown how estimates of parameters in the \mathbf{D} matrix may be obtained directly; here we show how to test specific hypotheses about direct and indirect homogamy. Phillips et al. (1988) reports data on general intelligence, educational level, extraversion, anxiety, tough-mindedness and independence in both husbands and wives. The first diagonal element of \mathbf{D} therefore represents direct homogamy for intelligence; by fixing this parameter to zero we test the statistical significance of the process.

```
#Ngroups 1
Assortative mating: Phillips data, Test that D 1 1 is zero
Data NInput_vars=12 NObservations=334
CMatrix File=asmat.cov
Begin Matrices;
  H Symm 6 6 Free
  W Symm 6 6 Free
  D Full 6 6 Free
End Matrices;
Start 1. H 1 1 H 2 2 H 3 3 H 4 4 H 5 5 H 6 6
Start 1. W 1 1 W 2 2 W 3 3 W 4 4 W 5 5 W 6 6
Fix D 1 1
Covariance
      H | H*D'*W_
      W*D*H | W      /
Option RSiduals
End
```

6.3 Fitting Models with Non-linear Constraints

Principal Components

Any symmetric matrix \mathbf{C} may be decomposed to a product \mathbf{ABA}' where \mathbf{B} is a real diagonal matrix and \mathbf{A} is a real orthogonal matrix, i.e. $\mathbf{AA}'=\mathbf{I}$. The elements of \mathbf{B} are *eigenvalues* of \mathbf{C} and the columns of \mathbf{A} are the *eigenvectors* of \mathbf{C} . In general, if we fitted a model \mathbf{ABA}' where \mathbf{A} was full and \mathbf{B} was diagonal, it would be underidentified, since there would be more parameters in the model than in the observed covariance matrix \mathbf{C} . However, we can supply the identifying constraints that \mathbf{A} is *orthogonal*. In the MX input file, these constraints are imposed in group 2, by setting $\mathbf{AA}'-\mathbf{I}=\mathbf{0}$. This is not an efficient method of obtaining eigenvalues and eigenvectors of a matrix, but it does highlight non-linearly constrained optimization. For eigenvalue and eigenvector functions, see Table 4.5.

```

#Ngroups 2
Principal components ABA' with constraints to keep A orthogonal
Data NInput_vars=3 NObservations=100
CMatrix Symm
  1.
  .6 .9
  .4 .2 .7
Matrices
  A Full 3 3
  B Diag 3 3
Covariances A*B*A'/
Specification A 1 2 3 4 5 6 7 8 9
Specification B 10 11 12
Start 1.0 A(1.1) A(2.2) A(3.3) B(1.1) to B(3.3)
Option LS
End

```

```

Here is the constraint A*A'=I
Constraint NInput_vars=3
Matrices
  A Full 3 3 = A1
  I Identity 3 3
Constraint A*A'=I /
Option LS
End

```

Analysis of correlation matrices

As Lawley and Maxwell (1971 ch. 7) pointed out, it is incorrect to analyze correlation matrices by maximum likelihood as if they were covariance matrices,. Incorrect analysis leads to biased estimates of the confidence intervals (even the likelihood-based confidence intervals supplied by MX). Likewise, the goodness-of-fit statistics can be biased, with corresponding bias in the tests of hypotheses that use the likelihood ratio test. These problems are limited to the analysis of correlation matrices using the maximum-likelihood method and do not apply to asymptotic weighted least squares. The easiest way to avoid this problem – and one that we most strongly recommend – is to fit models to covariance matrices (or raw data) wherever possible.

If it is necessary to fit a model to an observed correlation matrix (perhaps because the correlation matrix is the only available data, possibly published without variances or standard deviations) then MX can be used for correct analysis. The maximum-likelihood fit function for covariance matrices assumes that the diagonal elements of the covariance matrix are free to vary. If they are all constrained to equal unity, then a modified fit function is required. A simple way to implement this alternative fit function in MX is to add a constraint group which forces the diagonal elements of the correlation matrix to equal unity, but which does not contribute to the fit function. To illustrate the effects of correct vs. incorrect analysis, we use the data of Lawley and Maxwell (1971). Nine tests of cognitive ability were administered to seventh and eighth grade students by Holzinger and Swineford (1939). The model has three-factors and is shown in Figure 6.4.

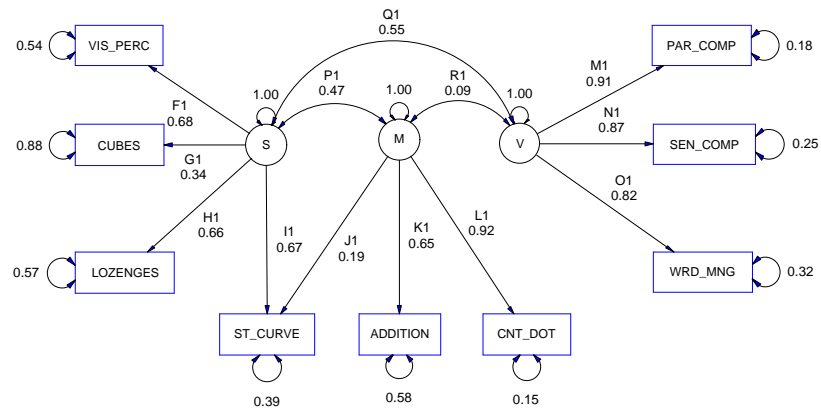

Figure 6.5 Three factor model of 9 cognitive ability tests (Lawley & Maxwell, 1971)

```

Lawley and Maxwell (1971) Analysis of correlation matrix
#Ngroups 2
#include lawley.dat
Begin Matrices;
  A Full 9 3
  E Diag 9 9 Free
  R Stan 3 3 Free
End Matrices;
Label Row E
  visperc cubes lozenges parcomp sencomp wrdmng addition cntdot stcurve
Label Col E
  visperc cubes lozenges parcomp sencomp wrdmng addition cntdot stcurve
Label Row A
  visperc cubes lozenges parcomp sencomp wrdmng addition cntdot stcurve
Label Col A Visual Verbal Speed
Specify A
  13 0 0
  14 0 0
  15 0 0
  0 16 0
  0 17 0
  0 18 0
  0 0 19
  0 0 20
  22 0 21
Start .5 all
Intervals A 4 2 A 5 2 A 6 2
Covariance A&R + E.E;
Options RSidual Multiple
End Group
    
```

```

Constraint Group to make unit diagonal of predicted cov matrix in group 1
Constraint
Matrices = Group 1
  B Unit 1 9 ! Matrix of 1's
End Matrices;
! use the \d2v function to extract the diagonal to a vector
Constraint B = \d2v (A&R + E.E') ;
Option df=-9 ! Eliminate degrees of freedom credit for constraints
Option CI=90
End Group

```

The output with the constraints gives confidence intervals on the loadings from the verbal factor to the verbal tests:

Matrix	Element	Int.	Estimate	Lower	Upper	Lfail	Ufail
A	1	4 2 95.0	0.9081	0.8284	0.9727	0 0	0 0
A	1	5 2 95.0	0.8674	0.7774	0.9310	0 0	0 0
A	1	6 2 95.0	0.8241	0.7240	0.8913	0 0	0 0

To compare these results with the incorrect results that do not include the non-linear constraint group, the second group was deleted, and NGroups was reduced to 1. This incorrect analysis gives much larger confidence intervals on the parameters:

A	1	4 2 95.0	0.9081	0.7334	1.1178	0 0	0 0
A	1	5 2 95.0	0.8674	0.6877	1.0816	0 0	0 0
A	1	6 2 95.0	0.8241	0.6402	1.0425	0 0	0 0

Given that these confidence intervals represent approximately 1.96 times the standard errors reported by Lawley and Maxwell, both sets of results closely agree with theirs.

Fitting a PACE Model to Contingency Table Data on MZ and DZ Twins

In order to fit a model with additive genetic, common and specific environment components to categorical data collected from twins, we are faced with two possibilities. One, we could use PRELIS or similar software to estimate tetrachoric or polychoric correlation matrices and associate asymptotic weight matrices, or two, we could fit directly to the contingency tables. Only the latter approach is suitable for models of phenotypic interaction between the twins. Phenotypic interaction leads to different variances between MZ and DZ groups, or in the case of categorical data, to proportionate group differences in the thresholds. This example uses a simple PACE model (see the example shown on page 114) fitted to 2×2 contingency tables obtained from MZ and DZ twin pairs. There is no information on the total variance in these data; but there is information on the relative magnitude of the variance in MZ and DZ groups (via the thresholds). Therefore, it is necessary to constrain the total variance prior to interaction to unity. This is done in the fourth group. Thresholds are constrained equal across groups.

```

#Ngroups 4
Categorical data analysis. PACE model
Calculation

```

```

Begin Matrices;
  X Lower 1 1 Free    ! genetic structure
  Y Lower 1 1 Free    ! common environmental structure
  Z Lower 1 1 Free    ! specific environmental structure
  P Full 2 2          ! interaction parameters
  I Iden 2 2
  T Full 2 1
  H Full 1 1
End Matrices;
Specification P 0 4 4 0
Boundary -.99 .99 4
Specification T 5 6
Matrix H .5
Start .6 All
Begin Algebra;
  A= X*X' ;
  C= Y*Y' ;
  E= Z*Z' ;
  B=(I-P)' ;
End Algebra;
End

```

```

G2: Monozygotic twin pairs
Data NInput-vars=2
CTable 2 2
File=usmz.ctg
Matrices= Group 1
Thresholds T /
Covariances A+C+E | A+C _ A+C | A+C+E /
End

```

```

G3: Dizygotic twin pairs
Data NInput_vars=2
CTable 2 2
File=usdz.ctg
Matrices= Group 1
Thresholds T /
Covariances A+C+E | H@A+C _ H@A+C+| A+C+E /
Options Iterations=300
End

```

```

Constraint group to ensure  $a*a + c*c + e*e = 1$ 
Data Constraint NInput=1
Matrices= Group 1
I Identity 1 1
Begin Algebra;
S= (A|C|E);
End Algebra;
Constraint I = S*S' /
End

```

Twins and their Parents: Cultural and Genetic Transmission

The model described has been developed extensively in the univariate and multivariate case (Eaves et al., 1978; Fulker, 1982; Neale & Fulker, 1984; Vogler, 1985; Fulker, 1988; Phillips et al., 1988; Cardon, Fulker & Jöreskog, 1991, Neale et al., 1994). In order to preserve consistency with the ACE model presented for twin data alone, the same separation of environmental effects is made here, following the last of the referenced papers instead of the earlier treatments. A path diagram of the model is shown in Figure 6.6.

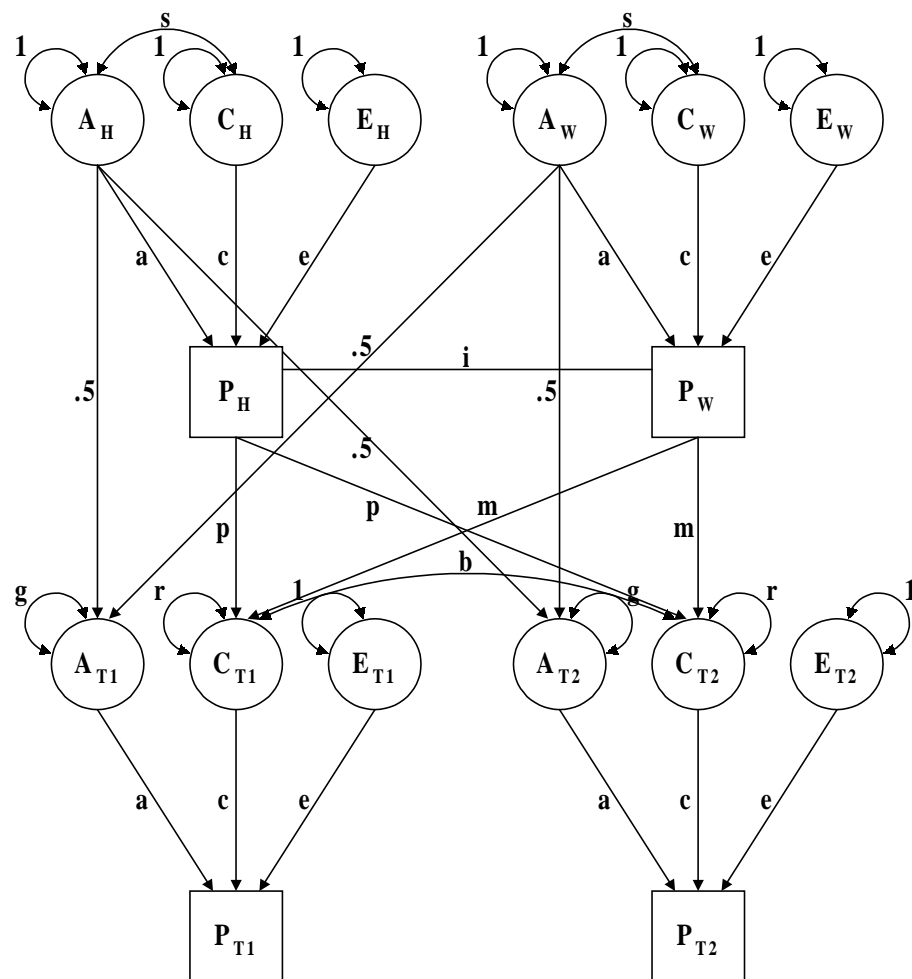

Figure 6.6 Model of mixed genetic and cultural transmission for data collected from twins and their parents. Phenotypes of a husband and wife (P_H and P_W) directly affect the shared environment of their children (C_{T1} and C_{T2}). Assortative mating, represented by a copath (i) based on phenotypes generates covariance between the latent variables of the parents. The additive genetic and shared and specific environmental effects (parameters a , c and e) and the covariance of A and C (parameter s) are assumed to be equal across generations. Genetic transmission from parents to offspring is fixed at one half.

```

Labels Row A
!1 2 3 4 5 6 7 8 9 10 11 12 13 14 15 16 17
PH PW PMZ1 PMZ2 PDZ AH CH EH AW CW EW AMZ CE EMZ1 EMZ2 ADZ EDZ
Labels Col A PH PW PMZ1 PMZ2 PDZ AH CH EH AW CW EW AMZ CE EMZ1 EMZ2 ADZ EDZ
Value 0.5 A 12 6 A 12 9 A 16 6 A 16 9

```

```
Specify S
```

```

0
0 0
0 0 0
0 0 0 0
0 0 0 0 0
0 0 0 0 0 0
0 0 0 0 0 8 0
0 0 0 0 0 0 0 0
0 0 0 0 0 0 0 0 0
0 0 0 0 0 0 0 0 8 0

```

```

0 0 0 0 0 0 0 0 0 0 0
0 0 0 0 0 0 0 0 0 0 0 5
0 0 0 0 0 0 0 0 0 0 0 0 6
0 0 0 0 0 0 0 0 0 0 0 0 0 0
0 0 0 0 0 0 0 0 0 0 0 0 0 0 0
0 0 0 0 0 0 0 0 0 0 0 0 0 0 5
0 0 0 0 0 0 0 0 0 0 0 0 0 0 0 0

```

```

Labels Col S PH PW PMZ1 PMZ2 PDZ AH CH EH AW CW EW AMZ CE EMZ1 EMZ2 ADZ EDZ
Labels Row S PH PW PMZ1 PMZ2 PDZ AH CH EH AW CW EW AMZ CE EMZ1 EMZ2 ADZ EDZ
Start 1.0 S 6 6 S 7 7 S 8 8 S 9 9 S 10 10 S 11 11 S 14 14 S 15 15 S 17 17

```

```
Begin Algebra;
```

```
R = (I-A)~&S ;
```

```
End Algebra;
```

```
End
```

```
Group 2 - Calculations
```

```
Calculation
```

```
Begin Matrices;
```

```
X IZero 2 17
```

```
R Comp 17 17 =R1
```

```
Y ZIden 17 15
```

```
Z ZIden 15 17
```

```
I Iden 2 2
```

```
M Symm 2 2
```

```
End Matrices;
```

```
Specify M 0 7 0
```

```
Start .1 M 2 1
```

```
Begin Algebra;
```

```
A= X*R*X' ; ! covariance matrix of parents
```

```
B= X*R*Y ; ! covariance of parent phenotypes with other variables
```

```
C= Z*R*Z' ; ! covar. of variables that are not parents' phenotypes
```

```
D= (A+M)| (A+M)*A~*B _
```

```
((A+M)*A~*B)'|C-B'&(A~*(I-(A+M)*A~)); ! handle the effects of assortative mating
```

```

End Algebra;
Options RSiduals
End

Group 3 - Constraints on kids' G-E variance and covariance
Constraint
Begin Matrices;
  E Computed 17 17 = D2
  C Stan 2 2
  F Full 2 17
Constraint \vec(F&E)=\vec(C) /
Specify C 8
Matrix F
  0 0 0 0 0 0 0 0 0 0 0 1 0 0 0 0 0 0
  0 0 0 0 0 0 0 0 0 0 0 0 1 0 0 0 0 0
Labels Row F PH PW PMZ1 PMZ2 PDZ AH CH EH AW CW EW AMZ CE EMZ1 EMZ2 ADZ EDZ
Options RSiduals
End

Group 4 - MZ twins & their parents
Data NInput_vars=4 NObservations=144
CMatrix File=usfearmz.cov
Matrices
  C Computed 17 17 = D2
  F IZero 4 17
Covariances F*C*F'/
Options RSiduals
End

Group 5 - DZ twins & their parents
Data NInput_vars=4 NObservations=106
CMatrix File=usfeardz.cov
Matrices
  C Computed 17 17 = D2
  F Full 4 17
Covariances F*C*F'/
Matrix F
  1 0 0 0 0 0 0 0 0 0 0 0 0 0 0 0 0 0
  0 1 0 0 0 0 0 0 0 0 0 0 0 0 0 0 0 0
  0 0 1 0 0 0 0 0 0 0 0 0 0 0 0 0 0 0
  0 0 0 0 1 0 0 0 0 0 0 0 0 0 0 0 0 0
Options RSiduals IT=500
End

Group 5 - Summarize parameter estimates
Calculation
Matrices
  P Full 1 8
Compute P/
Labels Col P A C E Q ResGs ResCt Mu S

```



```

Specification P 1 2 3 4 5 6 7 8
Start .7 P 1 1 P 1 3
Start .5 P 1 5
Start 1 P 1 6
Start .1 P 1 4 P 1 8
End

```



Computationally Efficient Approach

It is possible to get much faster turnaround with computationally efficient approaches to structural modeling of twins and their parents. In our second script the model for mixed genetic and cultural transmission was specified in terms of the covariances as derived from the rules of path analysis. This is the ‘correlational model’ described in Neale et al. (1994) but simplified with the algebra syntax. In group 1 all the model parameters are declared in separate matrices. In addition to the **A**, **C** and **E** matrices for additive genetic (A), shared environmental (C) and unique environmental (E) factors, parameters for the residual additive genetic variance (R_A), the residual common environmental variance (R_C) and the genotype-environment covariance (s) are specified in matrices **G**, **R** and **S**. The genetic transmission paths are fixed to .5 (matrix **H**). Separate cultural transmission paths are estimated for the maternal (m) and the paternal (p) effects in matrices **M** and **F**. The matrix **B** controls the common environmental residual variance and reflects thus the shared environmental effects of non-parental origin. Assortative mating is modeled as a copath (Eerdewegh, 1982) in matrix **D**. Matrix **P** represents the within person covariance. Finally the model allows for non-additive paths (N), but they cannot be estimated simultaneously with the cultural transmission paths in the twin-parent design. The matrices declaration section is ended with the `End Matrices;` statement, and followed by starting values and boundary constraints for the parameters. Expressions for the expected correlations between the relevant family members (spouses, father-child, mother-child, MZ twin and DZ twin) are given in the multistatement algebra section, indicated by the `Begin Algebra;` `End Algebra;` commands.

The model is not identified without nonlinear constraints on certain parameters. These are specified in groups 2 to 5. The within person phenotypic variance is equated to the sum of all genetic and environmental components in group 2. Group 3 equates the genetic variance in children to that of the parents. Similar constraints on the genotype-environment covariance and the environmental variance are calculated respectively in groups 4 and 5.

The observed data are supplied and the fit function is calculated in group 6 for MZ twins and their parents and group 7 for DZ twins and their parents. The expected covariance of these groups is a simple combination of the expected covariances for the respective relationships, as calculated in group 1, using horizontal and vertical adhesion. The only difference between the two groups is the expectation for the covariance between twin 1 and twin 2.

Modifications to the MX code are relatively simple to make. Additionally, facilities for dropping parameters to fit reduced models or for adding different data summaries make this example a convenient starting point for comprehensive analyses of data from all types of nuclear family and twin and parent data.

```

! Rose Fear data: Social phobia
! Twins and parents: Genetic and cultural transmission model.
! P--P assortment

#Ngroups 7
G1: Model parameters
  Calculation
  Begin Matrices;
    D Full nvar nvar free ! assortative mating paths
    P Symm nvar nvar free ! within person covariance (Rp)
    A Low nvar nvar free ! additive genetic paths
    C Low nvar nvar free ! common environment paths
    F Full nvar nvar free ! paternal cultural transmission
    M Full nvar nvar free ! maternal cultural transmission
    G Symm nvar nvar free ! additive genetic covariance (Ra)
    S Full nvar nvar free ! A-C covariance
    R Symm nvar nvar free ! common environment covariance (Rc)
    E Low nvar nvar free ! specific environment paths
    N Low nvar nvar ! non-additive paths
    H Full 1 1 ! scalar, .5
    I Iden 1 1 ! identity matrix
    B Iden 1 1 ! common env residual variance
  End Matrices;

  Matrix H 0.5
  Start 1.0 P 1 1
  Start 1.0 G 1 1
  Start .5 A 1 1
  Start .5 C 1 1
  Start 1.0 R 1 1
  Start .707 E 1 1
  Bound 0 1 D 1 1 1

  Begin Algebra;
    W= P*D*P' ; ! Mother-Father Cov
    T= G*A' + S*C' ; ! Genotype-Phenotype Cov
    O= (P*F+ W'*M')*C'+ (I+ P*D')*T'*(H@A') ; ! Father-Child Cov
    Q= (P*M'+ W*F')*C'+ (I+ P*D)*T'**(H@A') ; ! Mother-Child Cov
    J= A*S*C'+ C*S'*A' ;
    U= A&G+ C&R+ J + N*N' ; ! MZ Twin
    V= H@A*(G+ H@(T&(D'+D)))*A'+ C&R+ J+ H@H@N*N' ; ! DZ Twin
  End Algebra;
  Option Rsiduals
End

G2: Phenotypic Variance Constraint
Data Constraint NInput=1
Matrices= Group 1
Constraint P- (A&G+ C&R+ E*E'+ A*S*C'+ C*S'*A'+ N*N') /
End

```

```

G3: Genetic Constraint
  Constraint
  Matrices= Group 1
  Constraint G= (H@(G+ H@(T*(D'+D)*T')+ I)) /
End

G4: A-C Constraint
  Constraint
  Matrices= Group 1
  Constraint S= (H@T*(M'+ F'+ D*P*M'+ D'*P*F')) /
End

G5: Common Environment Constraint
  Constraint
  Matrices= Group 1
  Constraint R= (M*P*M'+ F*P*F'+ M*W*F'+ F*W'*M'+ B) /
End

G6 - MZ Twins and parents
  Data NInput=4 NObservations=144
  Labels DAD_1 MOM_1 T1_1 T2_1
  CMatrix File=usfearmz.cov
  Matrices= Group 1
  Covariance ( P | W' | O | P )_
              ( W | P | Q | Q )_
              ( O' | Q' | P | U )_
              ( O' | Q' | U' | P ) /
  Option RSiduals
End

G7 - DZ twins and parents Rose Fear Factor 1
  Data NInput=4 NObservations=106
  Labels DAD_1 MOM_1 T1_1 T2_1
  CMatrix File=usfeardz.cov
  Matrices= Group 1
  Covariance ( P | W' | O | P )_
              ( W | P | Q | Q )_
              ( O' | Q' | P | V )_
              ( O' | Q' | V' | P ) /
  Option Rsiduals
  Option Iterations=800
  Option Multiple
End

! Re-fit model with father-child and mother child cultural transmission set equal
  Equate F 1 1 1 M 1 1 1
End

```

6.4 Fitting Models to Raw Data

When models are fitted to raw data, it is normal to provide a model for the means as well as for the covariances. Otherwise, there is little difference in the approaches. MX computes minus twice the log-likelihood of the data, with an arbitrary constant that is a function of the data. Thus there is no overall measure of fit, but there are relative measures of fit, since differences in fit function between submodels are distributed as χ^2 .

Estimating Means and Covariances

This section demonstrates maximum likelihood estimation using complete, balanced raw data. A Cholesky decomposition (see Figure 6.2) is used for the covariance structure, and the means are estimated separately. Alternative models for covariances or means or both could be used if desired.

```

!
! ML fitting to raw data simulated
! with SAS, whose PROC COR COV gave:
! VARIABLE          N          MEAN          STANDARD
!                   N          MEAN          DEVIATION
! P1                 1000       0.00182388   0.98499439
! P2                 1000      -0.98608262   1.40083917
! P3                 1000       2.05400385   1.79139557
!
! COVARIANCE MATRIX
!                   P1          P2          P3
! P1          0.970214  0.506058  0.620529
! P2          0.506058  1.96235   0.807754
! P3          0.620529  0.807754   3.2091
!
!
! Cholesky for covariance structure
ML example, calculation of likelihood for each observation.
Data NInput_vars=3 NObservations=1000 NGroups=1
Rectangular File=mlped.raw
Begin Matrices;
  M Full 1 3 Free
  S Lower 3 3 Free
End Matrices;
Matrix_Start_values S
1
.6 .8
.6 .0 .8
Means M /
Covariances S*S' /
End

```

The relevant part of the output from this job shows good agreement with the SAS results, calculating means and covariances in the usual fashion, as would be expected for a sample size of 1000. The estimates of the variances are slight underestimates since the ML estimate of a variance is biased, having denominator n instead of $n-1$. Multiplying the ML estimates by 1000/999 we recover the calculated covariances precisely.

```
ML EXAMPLE, CALCULATION OF LIKELIHOOD...
Matrix M
  This is a FULL matrix of order   1 by   3
    0.0018  -0.9861   2.0536
Matrix S
  This is a constrained a FULL matrix of order   3 by   3
    0.9692   0.5056   0.6199
    0.5056   1.9604   0.8069
    0.6199   0.8069   3.2059
```

Variable Pedigree Sizes

When there are many different possible configurations of data, it is most convenient to use a variable length data file (see page 44). This information can be read by MX and the likelihood of the data may be calculated for any structural model for the covariances and the means. In this example, a Cholesky decomposition (see Figure 6.2) of the expected covariance matrix is specified in Group 1.

```
! ML fitting to variable length data
! Cholesky decomposition for the expected covariance matrix
! Also matrix expression for means
! - in this case just a simple vector with free parameters
Variable pedigree size ML example
Data NInput_vars=3 NObservations=1000 NGroups=1
VLength File=unbal.raw
Begin Matrices;
  M Full 1 3 Free
  S Lower 3 3 Free
End Matrices;
Start .7 S 1 1 - S 3 3
Means M /
Covariances S*S' /
End
```

Typical lines of the data file unbal.raw look like this:

```
2
1 2 0.5550 -1.1114
3
1 2 3 1.6442 -0.1319 3.609508
3
1 2 3 -0.2145 -1.2193 5.011667
3
1 2 3 2.2274 -1.9423 0.714351
```

There can be problems when beginning to fit models to VL data. One commonly encountered difficulty is that at the starting values, the likelihood is effectively zero for one or more pedigrees. Since MX is going to try to take the logarithm of the likelihood, some corrective action is required. During iteration a penalty function is used, but this doesn't help the case where there are poor starting values. To help guide the user to the problem with the starting values, MX prints out 3 columns of information: the observed and expected means, and then the standardized difference between them. Now if these differences are large (say more than 3 for any variable), it would be a good idea to change starting values of either the means (to make the expected ones closer to the observed) or the variances (to make the standardized difference less). If the starting values of the means are very bad, then it would make sense to change them; however, if they are not, the error may occur with another vector in the dataset, in which case modifying the starting values to increase the expected variances should help. If not, examine the expected covariance matrix; sometimes large expected covariances can make particular pairings of scores rather unlikely. It is usually better to supply starting values that specify a diagonal variance-covariance matrix, since the overall likelihood is simply the product of the likelihoods of the individual variables. If each of these likelihoods is reasonable, e.g. a standardized difference of less than 2, then the overall likelihood will not produce problems unless the number of variables in the vector is large.

Definition Variables

For example: suppose that the variances of and covariance between two variables vary as a function of age. A traditional approach to this problem might involve splitting the sample into two groups, young and old, and fitting a two-group model. Comparison of the fit statistic obtained when the covariance is constrained to be equal in the two groups to that obtained when each group has its own covariance structure provides a test of heterogeneity. But what if we want to use all the information on age, which is a continuous variable, instead of an arbitrary cutoff for young vs. old?

We can use the observed age variable to define the covariance structure for that particular observation. That is, we want to fit a model of the form

$$y_i = \mathbf{L}\mathbf{f} + \mathbf{X}\text{age}_i$$

where \mathbf{L} and \mathbf{X} are lower triangular matrices, \mathbf{f} is a vector of independent random variables with mean zero and unit variances, and age_i is a vector with age_i as each element. Thus the covariance of y_i will be

$$\text{Cov}(y_i, y_i) = \mathbf{L}\mathbf{L}' + \mathbf{X}\mathbf{R}\mathbf{X}'$$

where \mathbf{R} is a diagonal matrix with age_i as all elements. A script to fit this model is shown below. Let variables 1, 2 and 3 correspond to verbal IQ, quantitative IQ, and age, which we read from file `iq.vl`. MX uses the `definition` keyword to identify variables that are to be; they are extracted from the dataset so modeling is restricted to the other variables V and Q (see figure 6.7).

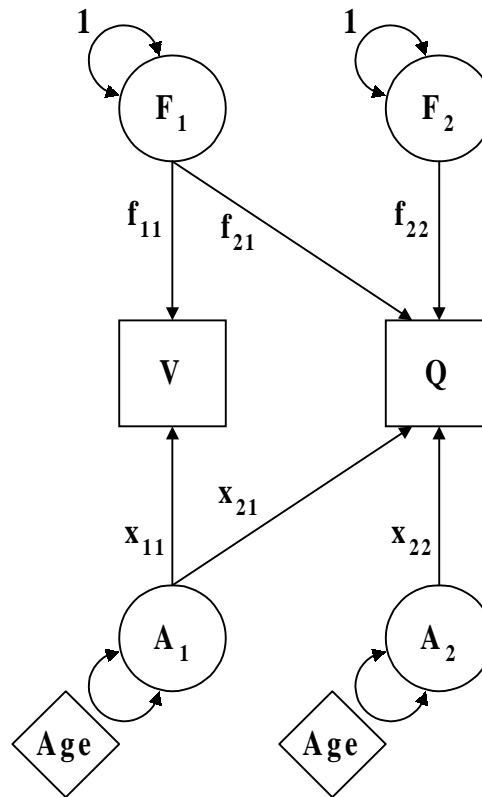

Figure 6.7 Definition variable example.

```

Title - verbal and performance IQ covariance as a function of age
Data NInput=3 NGroups=1      ! Single group example with 3 variables
Labels Verbal Quant Age
VL file=IQ.VL
Definition_variables Age /    ! This variable is referenced as -1 in
!                             specification statements
Matrices
  L Lower 2 2 Free  ! Triangular matrix of paths from factor Fi to variable Oj
  X Lower 2 2 Free  ! Triangular matrix of paths from factor Ai to variable Oj
  R Diag  2 2      ! Matrix for variances of Ai latent variables
  M Full  1 2 Free ! Matrix for estimating means

Means M /
Covariance L*L' + X*R*X' / ! Formula to compute covariances
Specify R -1 -1 ! Place definition variable on the diagonal elements of R
Matrix M 100 100 ! Starting values for means
Matrix L 15 0 15 ! Starting values for constant covariance component
Matrix X 3 0 3   ! Starting values for age-dependent covariance component
Option RSiduals ! Request some output
End

```

Internally, MX will recalculate the predicted covariance matrix for every observation¹⁰. The usual raw data log-likelihood function is computed for every vector of observations, but using the appropriate covariance matrix for this group. If we were to assign one and zero to the age variable in accordance to our cutoff approach, we would get the same results as the two-group heterogeneity method.

Apart from this handling of continuous heterogeneity, we should be aware that considerably more complex models may be attacked. All the tools of MX matrix functions and operators may be used to define linear and non-linear functions of the definition variables and model parameters.

Using NModel to assess heterogeneity

MX has special features for assessing possible mixtures of distributions. Almost all structural equation models make the implicit assumption that one model describes the whole population. In reality, the population may consist of several subpopulations. This type of analysis requires the raw data to be analyzed, and thus assumes a multivariate normal distribution of each of the component subpopulations. The likelihood function is modified for this type of mixture. Let L_1 be the likelihood under model 1 and L_2 be the likelihood under model 2. In both cases, this likelihood is computed with the multivariate normal probability density function, as described on page 64. The overall likelihood is computed as a weighted sum of the likelihoods for each model, and the log-likelihood is the logarithm of this overall likelihood. MX lets you enter any matrix formula for the weights; here we illustrate the method with a simple proportion.

Suppose that the population consists of a mixture of two groups, one with population covariance matrix

$$\Sigma_1 = \begin{bmatrix} 1 & \\ .8 & 1 \end{bmatrix}$$

and the second with covariance matrix

$$\Sigma_2 = \begin{bmatrix} 1 & \\ .2 & 1 \end{bmatrix}$$

Using SAS, a data set of 500 pairs of scores for each of the two groups was simulated. In addition, two further scores were added to the dataset: (i) a measure of group membership, being $N(0,1)$ for the first group, and $N(1,1)$ on the second – a normally distributed indicator with a 1 standard deviation difference between the groups; and (ii) a key variable scored 0 for the first group and 1 for the second. The observed covariance matrices for the two groups and the recovered estimates for a variety of models are shown in Table 6.1. First, the results of fitting a model with no heterogeneity. The covariance is estimated at .47 which is approximately half way between .2 and .8 simulated for the two populations.

¹⁰ In fact, it only does this if the definition variables have different values from the preceding case, so sorting may improve performance if the definition variables are quasi-continuous or ordinal.

Second are the results of attempting to detect this heterogeneity with a simple model that tries to estimate the proportions in the two samples. There is evidence of heterogeneity here, because the fit function has improved compared to model 1. However, the parameter estimates recovered are not good estimates of the population statistics, particularly for the low correlation group, whose proportion is estimated at only .27 of the population. Better estimates are recovered when the true population proportion is used (Fixed Heterogeneity model). Therefore, without external indicators, it seems dangerous to draw conclusions about the proportions in the population, unless sample sizes are much larger than they are here. The Fixed Indicator model uses the information from the indicator variable to partially discriminate between the populations. A better fit is found, and good recovery of the population parameters is obtained. To make this model realistic, the relationship between the indicator and group membership should be estimated. Again, the parameter estimates are less realistic, particularly for the less correlated subpopulation, when the proportions are estimated rather than given.

In summary, it may be possible to detect the presence of heterogeneity in a raw dataset with a moderately large sample size. However, unless one has a good indicator variable - and knows its relationship to the variables being analyzed - it is difficult to quantify the way in which the 'latent groups' differ. One example where a good indicator variable is available is genetic linkage (Eaves et al., 1996). Modeling heterogeneity with and without indicators is in need of further study, both the complexity of the models used, and the sample proportions.

Table 6.1 Summary of parameter estimates for a variety of models of heterogeneity

Model	V1	C	V2	p	-2ln L	df
One model	1.0093	0.4699	0.8394		5344.12	1995
Estimated Heterogeneity	0.5949 1.1779	-0.1968 0.7259	1.0359 0.8840	0.2727	5289.39	1991
Fixed Heterogeneity	0.8409 1.1957	0.1353 0.8113	1.0065 0.8449	.5000	5293.28	1992
Fixed Indicator	0.9460 1.0920	0.1721 0.7764	0.9830 0.8679		5267.59	1995
Estimated Indicator	0.6794 1.1672	-0.1476 0.7456	1.0017 0.8922		5263.80	1988
Perfect Indicator	0.9997 1.0393	0.1356 0.8125	0.8473 1.0036		5101.71	1992

Data were simulated with unit variance and .8 correlations for 500 cases, and unit variance and .2 correlation for 500 cases.

```

#Ngroups 1
No heterogeneity
Data NInput=4 Nobservations=0
Rectangular File=sim1.both
Labels X Y Z Key
Select X Y /
Begin Matrices;
  A Lower 2 2 free
  M Full 1 2 free
End Matrices;
Start 1 A 1 1 to A 2 2
Means M ;
Covariance A*A' ;
Option Mx%p=indiv1.lik
End Group;

#Ngroups 1
Simple Heterogeneity - two models, no indicator
Data NInput=4 Nobservations=0 Nmodel=2
Rectangular File=sim1.both
Labels X Y Z Key
Select X Y /
Begin Matrices;
  A Lower 2 2 free
  B Lower 2 2 free
  I Unit 1 1
  M Full 1 2 free
  P Full 1 1 free ! proportion in subpopulation 1
End Matrices;
Start 1 A 1 1 to A 2 2
Start .5 B 1 1 to B 2 2 P 1 1
Bound .001 .999 P 1 1
Begin Algebra;
  Q = I - P;      ! proportion in subpopulation 2
  W =      P      _
      Q ;      ! vector of weights
End Algebra;
Means M_M ;
Covariance A*A' _B*B' ;
Weight W ;
Option Mx%p=indiv.lik ! put individual likelihood statistics to file
Option RSiduals Multiple
End Group;

! Fixed proportions heterogeneity
Drop @.5 P 1 1 1
Exit

#Ngroups 1

```

```

Estimated indicator
Data NInput=4 Nobservations=0 Nmodel=2
  Rectangular File=sim1.both
  Labels X Y Z Key
  Select X Y Z /
  Definition Z /
  Begin Matrices;
    A Lower 2 2 free ! Cholesky of first subpopulation covariances
    B Lower 2 2 free ! Cholesky of second subpopulation covariances
    I Unit 1 1
    M Full 1 2 free ! Vector of estimated means
    C Full 1 1
    J Full 1 1 free !Mean of first group on Z variable
    K Full 1 1 free !Deviation of Mean of second group
    L Full 1 1 free !Variance of first group on Z variable
    N Full 1 1 free !Variance of second group on Z variable
  End Matrices;
  Specify C Z
  Start 1 A 1 1 to A 2 2 L 1 1 N 1 1
  Start .5 B 1 1 to B 2 2 J 1 1
  Start .25 K 1 1
  Bound .1 3 L 1 1 N 1 1
  Bound 0 3 K 1 1
  Bound -3 3 J 1 1
  Begin Algebra;
    P = \pdfnor(C_J+K_N) % ( \pdfnor(C_J_L) + \pdfnor(C_J+K_N) ) ; ! compute prob
    Q = I - P;
    W = P_Q ;
  End Algebra;
  Means M_M ;
  Covariance A*A'_B*B' ;
  Weight W ;
  Option Mx%p=indiv.lik
  Option RS
End Group;

#Ngroups 1
Fixed indicator
Data NInput=4 Nobservations=0 Nmodel=2
  Rectangular File=sim1.both
  Labels X Y Z Key
  Select X Y Z /
  Definition Z /
  Begin Matrices;
    A Lower 2 2 free
    B Lower 2 2 free
    I Unit 1 1
    M Full 1 2 free
    C Full 1 1
    Z Zero 1 1

```

```

End Matrices;
Specify C Z ! put individual Z variable scores into matrix C
Start 1 A 1 1 to A 2 2
Start .5 B 1 1 to B 2 2
Begin Algebra;
  P = \pdfnor(C_I_I) % ( \pdfnor(C_Z_I) + \pdfnor(C_I_I) ) ;
      ! P computes probability separately for every case in the sample
  Q = I - P;
  W =      P _
        Q ;
End Algebra;
Means M_M ;
Covariance A*A'_B*B' ;
Weight W ;
Option Mx%p=indiv.lik
Option RS
End Group;

#Ngroups 1
Two groups, perfect indicator (Key)
Data NInput=4 Nobservations=0 Nmodel=2
Rectangular File=sim1.both
Labels X Y Z Key
Select X Y Key /
Definition Key /
Begin Matrices;
  A Lower 2 2 free
  B Lower 2 2 free
  F Full 1 1
  I Unit 1 1
  M Full 1 2 free
  C Full 1 1
  Z Zero 1 1
End Matrices;
Specify C Key
Matrix F 5
Start 1 A 1 1 to A 2 2
Start .5 B 1 1 to B 2 2
Begin Algebra;
  P = C ; ! compute prob
  Q = I - P;
  W =      P _
        Q ;
End Algebra;
Means M_M ;
Covariance A*A'_B*B' ;
Weight W ;
Option Mx%p=indiv.lik
Option RS
End Group;

```

6.5 User-Defined Fit Functions

Least Squares

This is a simple example to illustrate the use of a user-defined fit function, in this case least-squares. The model statement evaluates to a scalar which is minimized by MX. Note that this approach is generally less efficient than using built-in formulae available in MX, but it is much more flexible.

```
User defined function to fit to a correlation matrix by least squares
Data NInput_vars=3 NGroupies=1
CMatrix Symm
1
.2 1
.3 .4 1
Begin Matrices;
A Symm 3 3 = %01
B Stan 3 3 Free
End Matrices;
Begin Algebra;
D= \vec(A)-\vec(B);
End Algebra;
Compute \sum(D.D);
Option User
End
```

Correction for Ascertainment

On page 86, we described how proband-ascertained ordinal data could be used to estimate population covariances or genetically informative parameters. This same truncate selection might be applied using a screening instrument, so that only individuals above a certain threshold value are sampled. If such an ascertainment scheme was applied in a pairwise fashion, such that only pairs in which at least one of the pair was above threshold, the likelihood of these observations would require correction for the necessarily missing pairs concordant for being below threshold. Mathematically, the likelihood of pair ascertainment can be expressed as a double integral of the bivariate normal distribution:

$$L_{\tilde{A}} = \int_{-\infty}^t \int_{-\infty}^t \phi(v_1, v_2) dv_2 dv_1$$

where t is the ascertainment threshold, v_1 and v_2 are the liability values of individuals 1 and 2, and ϕ is the multinormal probability density function. The likelihood of a pair of observations x_1 and x_2 given the ascertainment scheme is therefore:

$$L(x_1, x_2 | A) = \frac{\phi(x_1, x_2)}{1 - \int_{-\infty}^t \int_{-\infty}^t \phi(v_1, v_2) dv_2 dv_1}$$

If we use twice the negative log-likelihood as a function to minimize, then the ascertainment correction becomes more clearly distinct:

$$\begin{aligned} -2\ln L(x_1, x_2|A) &= -2\left(\ln(\phi(x_1, x_2)) - \ln\left(1 - \int_{-\infty}^t \int_{-\infty}^t \phi(v_1, v_2) dv_2 dv_1\right)\right) \\ &= -2\ln(\phi(x_1, x_2)) + 2\ln\left(1 - \int_{-\infty}^t \int_{-\infty}^t \phi(v_1, v_2) dv_2 dv_1\right) \end{aligned}$$

when we have m pairs, the likelihoods are summed over $j=1\dots m$, giving

$$= -2\ln(\phi(x_{1j}, x_{2j})) + 2m\ln\left(1 - \int_{-\infty}^t \int_{-\infty}^t \phi(v_1, v_2) dv_2 dv_1\right)$$

The first term is the function value calculated by MX when fitting to raw data. The second term may be calculated by obtaining the value of the integral from a dummy categorical data group using zero observed frequencies in each cell. Parameter t , the threshold in this group should be fixed at the population value, and the correlation should be constrained to equal the correlation of these two variables as estimated from the ascertained data. The expected proportions under the bivariate normal distribution are passed as a matrix using the %P constraint as described on page 53.

```
Simulated twin data. Raw ML estimation
Data NInput=2 NGroups=3 NObservations=1000
Raw_data file=[neale.sas]mzasc.dat
Begin Matrices;
  M Full 1 2
  R Stan 2 2 Free
End Matrices;
Mean M /
Covariance R /
Matrix M 0 0
Bound -.99 .99 R 1 2
Option RSiduals
End
```

```
Dummy group to calculate expected cell proportions
Data NInput=2
CTable 2 2
  0 0
  0 0          ! It's full of zeros so it contributes zero to the function
Begin Matrices;
  T Full 2 1
  R Stan 2 2 = R1
End Matrices;
Matrix T
1.282 1.282
Thresholds T /
Covariance R /
Option RSiduals
```

```
End

Calculate ascertainment correction
Data NInput=0
Begin Matrices;
  I Iden 1 1
  J IZero 1 2
  P Full 2 2 = %P2
  T Full 1 1
End Matrices;
Matrix T 2000          ! twice the sample size of group 1
Compute T*\ln(I-J*P*J') /
Options User-defined RSiduals Multiple
End
```

Appendix A Using MX under different operating systems

A.1 Obtaining MX

Currently the MX statistical engine is available for several Unix systems including Linux, Solaris, Irix, IBM AIX, Digital Unix, HP Ux). Versions for most operating systems can be downloaded via the internet at <http://views.vcu.edu/mx>. The MX Graphical Interface (MXGUI) is available for MS Windows and MS-DOS and may be obtained from <http://www.vipbg.vcu.edu/mxgui>. It can use either the included DOS version or Unix version to analyze data.

A.2 System Requirements

To run the MX graphical interface, you need:

- An IBM-compatible PC running Windows 3.x or 95 or NT
- A 386-DX (or 386-SX with coprocessor) or above (486-DX, Pentium, etc.)
- A mouse or similar pointing device
- At least 6Mb of free disk space
- At least 16Mb of installed RAM

To use networked Unix workstations to run the MX statistical engine (for faster turnaround of cpu intensive jobs) a TCP/IP connection is needed.

A.3 Installing the MX GUI

Windows 95/98/NT

Download `mxgui95.zip` and unzip it into a directory such as `c:\temp1` (alternatively you can use WinZip <http://www.winzip.com> to unzip and install in a single step). Run the program `setup.exe` by double-clicking on it in the Windows Explorer and follow the instructions for the installation. Choose an installation directory that is different from the directory containing the `setup.exe` program.

Windows 3.xx

Download the file `mxgui31.zip` and unzip it into a directory such as `c:\temp1` (alternatively you can use WinZip <http://www.winzip.com> to unzip and install in a single step). Run the `setup.exe` file by double clicking on it in the File Manager and follow the instructions for the installation. Choose an installation directory that is different from the directory containing the `setup.exe` program; we recommend the default `C:\mxgui`.

A.4 Using MX

Windows

See Chapter 2.

Dos

MX is written in about 30,000 lines of FORTRAN, and it links to a further 20,000 lines of NPSOL code for optimization, so the resultant .exe file does not run within the 640K limit. Fortunately, the Lahey compiler allows binding of a loader to the code which permits MX to use memory beyond the 640K limit in 386 and 486 machines. If the program runs out of memory, it will use virtual memory (disk space) instead, but obviously this can drastically decrease performance. The use of Stacker (file compression software) also seems to slow things down, especially for the first run in a multiple fit file. Under DOS, performance can be improved if SMARTMEM is loaded.



Note the difference between your computer running out of memory and MX running out of workspace. Currently, the PC version is configured with 100,000 double precision words of workspace; larger workspace can be requested on the command line with e.g.

```
mx -k 500
```

which would request 500,000 words of workspace.

We recommend that input files have the naming convention `cutename.mx` where `cutename` is a name of your choice. To run MX on a PC, create an input script and type

```
mx cutename.mx {cutename.mxo}
```

if you are running DOS. MX now no longer requires that the output files be specified on the command line. With the syntax

```
mx cutename.mx
```

the output will be in a file called `cutename.mxo`

If you wish to use other extensions or names for input and output files, you could, for example, create a file called `badname.abc`, and use the syntax:

```
mx badname.abc awfulname.xyz
```

which would create an output file called `awfulname.mxo`. The command

```
mx badname.abc
```

would generate an output file called `badname.mxo`

Under Windows 3.x, 95 and NT, it is handy to use the Associate option in the File Manager, to associate .mx files with the `mx.exe` program file. Double-clicking a .mx file will then run MX and produce a .mxo output file. Feedback of function evaluations is printed on the screen. Alternatively the input file can be launched on the MX icon. Similarly the .mxo files can be associated with your favorite text editor/viewer, so that output files are easily read with a double click.

We can extend the idea of filename extensions a little further to include: covariance matrices, .COV; correlation matrices, .COR; contingency tables, .CTG; matrices, .MAT; variable length files, .VL; rectangular files, .REC; weight matrices, .ASY; inverted weight matrices, .ASI; vectors of means, .MEA; mx save files, .MXS. Of course, it doesn't make any difference to the program what you call the files, but some widely-used conventions such as these help you and other users to understand the content of the directory when you (or your colleagues) look at it six months later.

Hypertext output may be requested with the `-h` flag, e.g.

```
mx -h myfile.mx myfile.htm
```

would produce html output suitable for looking at with a browser like Netscape.

UNIX

MX may be used very simply in UNIX by typing

```
mx <inputfile >outputfile
```

and the parameter `&` may be added to run jobs in batch. For very cpu intensive applications the command

```
nice mx <inputfile >outputfile
```

may be used to run the job at lower priority to avoid overtaxing the system.

You can also use a `bmX` script which allows you to use the following syntax:

```
bmX inputfile
```

The `outputfile` is then automatically created as `inputfile.mXo`; the `bmX` script may be downloaded, but it is quite short:

```
(usr/local/bin/mX <${1}.mX >${1}.mXo; \  
echo "Mx has just finished a job for you ^G"; \  
echo "See output in ${1}.mXo")
```

and should be entered as a single line, with the literal character `ctrl-G` (ASCII code 7) to make a beep.

VAX VMS

The VMS version is no longer supported; however, version # is still available at the website. MX for VMS is distributed with a command file (`MX.COM`) which deals with file extensions and checks to see whether the user has sufficient memory resources. Typically one user at a site, the administrator, will keep the command and executable files with read and execute permission set for all users. Then if users define the symbol `mx` with a command such as

```
$ MX ::= "@DISK1:[BOSS.MX]MX.COM DUMMY"
```

where `DISK1` is the name of the diskdrive, `BOSS` is the name of the administrator, and `BOSS.MX` is the name of the subdirectory in which the `mx.com` and `mx.exe` files are stored. The above symbol definition will permit users to run MX either interactively or as a batch job. The only difference is that the former will produce a mesmerizing display of the MX logo and the latter will free up your terminal to do something else while it runs. The output file may be read while the program is running, though emptying the print buffer has been reduced to improve performance.

MX can be run either interactively with the following syntax:

```
$ MX CUTENAME
```

or alternatively, you can run the job in batch with

```
$ BAT/Q=whateveryoulike MX CUTENAME
```

for short jobs, ignore the `/Q=` bit. With this syntax, the output will be called `CUTENAME.MXO`.

There is also a facility, called `imX`, for editing jobs, running them, and viewing the output.

Appendix B Error Messages

B.1 General Input Reading

If, while looking for a number, a (non-comment) input line with only non-numeric characters on it (e.g. matrix P) is found, the program issues a warning:

```
**WARNING** Non-numeric characters found when trying to read a number
```

This is to alert the user to what is probably an error of not reading enough numbers, for one of these reasons:

- input lines are too long (1200 column maximum, except AIX (500))
- the matrix was given the wrong dimensions in the matrices command
- too few numbers have been supplied

This is not a fatal error, but normally some other problem will arise. Similarly, if too many numbers have been provided for a matrix, (or a mistake was been made when defining the type or dimensions of the matrix) the program will usually try to read a number as a keyword, ask something like “Just what is this keyword supposed to mean?” and stop.

Sometimes an integer overflow will occur if too many digits have been read in free format for a number. Try to keep the number of digits to 9 or less. If you really need more precision, use the exponential format (D+00) or read data from a file.

B.2 Error Codes

This is a list of the error codes reported by MX. The error messages are supposed to be self-explanatory, but they are usually quite brief. Here the *italic text* is the error, and ordinary type gives a little further explanation.

1. *First input line after title must be DATA.* Will occur if the Title line has been forgotten. Maybe, just MAYBE, you got your NG wrong.
2. *Data line must have NI and NO specified.* (Data groups only).
3. *End of file while trying to read title.*
4. *Must specify Matrices at this point...* Perhaps you have the wrong NI or the wrong matrix type - SY instead of FU?
5. *Not a legal matrix name.* Use A-Z, one letter only.
6. *Illegal matrix type...* Check for typos. You may use ZE, ID, IZ, ZI, DI, SD, SY, ST, FU, UN or LO.
7. *Sorry, I seem to be at the end of your input file.* Check NG is correct.
8. *Number of selected variables must be less than or equal to number of input variables NI ...* Otherwise you won't be analyzing something sensible and positive definite.
9. *Error - no variables selected for analysis.*
10. *Terribly sorry, I don't have enough workspace.*
11. *Please try not to refer to matrices that you haven't specified.*
12. *Please use only Pattern or Specification throughout.* Pattern and Specification cannot be used in the same input file.
13. *Error - no matrix specified...*
14. *More than 3 dimensions specified.* After a matrix name, there should be a maximum of 3 numbers to identify the element.
15. *Error - matrix has not been specified.*
16. *Matrix has been specified not to have free elements.* See Table ? to figure out which types of matrix can have free elements.

17. *You cannot alter off-diagonal elements of a diagonal matrix.*
18. *Incorrect element of a Subdiagonal matrix specified.* You can't alter elements on or above the diagonal of a Subdiagonal matrix.
19. *Incorrect element of a Standardized matrix specified.* You can't alter elements on the diagonal of a Standardized matrix.
20. *Please use 2 or 3 dimensional format for elements.* Array references should be group,row,col, with group optional.
21. *Sorry, I can't find your matrix element.* I really should tidy up sometime.
22. *I'm sorry, I don't understand this part of DATA line, so I'm ignoring it.* Note that MX is not LISREL and won't fiddle about changing data structures using the MA= command syntax. You can always do it explicitly in a little MX job which will be good for your immortal soul.
23. *Sorry, I couldn't invert your expected matrix.* If the method is ML, the expected matrix has to be invertible throughout optimization. MX will try to avoid non-positive definite areas with a penalty function.
24. *Sorry, I couldn't invert your asymptotic matrix.* If the asymptotic matrix is not positive definite, it must be fixed. Check the Select command for repetitions of a number, if it is used.
25. *Strangely, you seem to have requested an unknown matrix operation.* If you get this one, memory is screwed up somehow, and you should check your input file carefully before sending the problem to Mike Neale.
26. *Sorry, your model matrix has different dimensions from your data matrix.* A common silly mistake. Carefully figure out the dimension of your model, check NI parameter and Select command if used.
27. *Sorry, your expected matrix is not symmetric.* The matrix formula you provide should yield a matrix that is symmetric, if it is to be fitted to data.
28. ***Sorry, you must have symmetric or full model*** Same as previous message.
29. *Please try not to specify inverse for non-square matrices.* Generalized inverses are not available. If you are desperate, try transforming to a partitioned matrix that has a square matrix of full rank at one end.
30. *Sorry, had trouble transposing a matrix.* This is an unlikely error.
31. *Sorry, I couldn't find the determinant of a matrix.* I thought I put it on the shelf here somewhere... Probably zero.
32. *Uh-oh.. there's a problem with a binary operator.* This can happen when evaluating an illegal matrix expression, but it is unlikely.
33. *Sorry, the matrix addition screwed up.* Very unlikely.
34. *The matrices you wish to add are not conformable for addition i.e. the number of rows (columns) in matrix 1 is not the same as the number of rows (columns) in matrix 2.* Quite likely. If at first you don't succeed, check check and check again.
35. *The matrices you wish to multiply are not conformable for multiplication i.e. the number of columns in matrix 1 is not the same as the number of rows in matrix 2.* Be sure that you are using the right type of multiplication for your application, as well as checking the dimensions of the matrices you wish to multiply.
36. *You seem to have an unknown matrix type.* Very unlikely.
37. *I seem to be using an unknown fit function.* Very unlikely.
38. *You must specify 3 numbers for boundary constraints.* Lower bound, Upper bound, Parameter # or array element.
39. *First character after BOUNDARY must be alphanumeric.* Alphanumeric means alphabetic abcdefghijklmnopqrstuv or 01234356789.
40. *Sorry, to request AWLS for this group, you should have input an asymptotic covariance matrix.*
41. *I don't know to what you want me to equate this matrix.* Some error in the =Mi command to equate matrices. Equatee must be on the same input line.
42. *Sorry, I can't make this matrix equal to a matrix that you haven't supplied yet.* Reorder your groups if it isn't a typo.
43. *Uh-oh... I got stuck inverting a matrix while calculating expected matrix... If you are using an (I-B)⁻¹ formulation, make sure that the parameters in B do NOT have bounds +1 or -1. This error is a pain in the neck. If you get it a lot, let me know.* This can be awkward. Sometimes starting values or changing the boundaries on parameters can help.
44. *Uh-oh... I'm having trouble reading a number in D or E format.* Probably a typo in the data.
45. *Sorry - could you put the =filename on the same line as the FI, please?*
46. *Awfully sorry, I couldn't open a file for you.* Probably a spelling mistake in the filename.
47. *I deeply regret that your equality constraint refers to a non-existent matrix.*
48. *OH NO! The IOP parameter calling MSOFAR is wrong.* I have no idea what this error means. The good thing about it is that you are not likely to get it.

49. *Please don't mix the numeric and array references on a Bound line!* Use only parameter numbers or only matrix elements. I just get so terribly confused.
50. *There I was, looking for a number and - blow me down...* - I just could not find it. Probably an error in specifying the dimensions of a matrix. The end of file was found before the number.
51. *It seems rather strange to me to have a + or - sign without a number after it.* Well, wouldn't it seem strange to you?
52. *You seemed to put a * in the middle of two numbers but WRONGLY.* Do not pass GO, do not collect \$200.
53. *Uh-oh. Now there are too many numbers in a list.*
54. *Nincompoop. Your data matrix has to be positive definite for GLS.* Probably a little harsh, this message.
55. *Ouch! do not try to change your mind about the number of groups NG...* This used to cause big headaches.
56. *Awfully sorry, old chap, you're trying to | between matrices that have a different number of rows. No can do!* Check conformability.
57. *Awfully sorry, old chap, you're trying to _ between matrices that have a different number of columns. No way!* Check conformability.
58. *Uh-oh! Your formula has an illegal character.* Edit your input file and arrest this character immediately. On the IBM RISC 6000 it can occur spuriously and irrationally if you leave blank spaces at the start of a line following an underscore. Heaven knows why.
59. *Uh-oh! Your matrix expression has a mistake in it. Please fix it.* This could be unmatched parentheses, a missing operator or a missing matrix. Sorry that it isn't more specific... Also, the matrix formula is sensitive to un-trapped memory problems. One known possibility is that you have tried to do something to a range of matrices from different groups, e.g. Start 1 A 1 1 1 - A 4 3 3.
60. *There seems to a problem with your format in your data file.* Put the format in parentheses () or use * to read data in free format.
61. *Oh dear! The model you specified does not give the same number of rows in the Expected Matrix as there are in the Observed Matrix for this group.* Check the order of the model.
62. *Stack has overflowed - kick Mike Neale.* This is not necessary to fix the job. Your complicated expression ought to be simplified by using a CALC group to precalculate part of it.
63. *The matrices you wish to subtract are not conformable for subtraction. i.e. the number of rows (columns) in matrix 1 is not the same as the number of rows (columns) in matrix 2.* If this message doesn't add up to you, go back to elementary school.
64. *I'm terribly sorry, stack 1 has overflowed. Please abuse Mike Neale.* Simplify your expression with CALC groups.
65. *I'm terribly sorry, stack 2 has overflowed. Please abuse Mike Neale.* Simplify your expression with CALC groups.
66. *An undefined matrix has been encountered in the matrix formula.* Look for typos in the formula, and in the matrices command. You're using a matrix that hasn't been specified for this group.
67. *You seem to have missed out an operator...* Matrix names should be single letters only. Check the matrix formula for matrix names that are more than one letter.
68. *At first you put % but then there was neither O nor E nor R after it. Please try not to make grammatical errors like this.* So put O or E or R after it!
69. *You seem to be referring to parameter specifications for an Observed or Expected matrix...* There is no way that you are going to be allowed to do this.
70. *I want you to get this right. If you equate to the Observed or Expected matrix, you must specify a symmetric or full matrix.* Get it right.
71. *The matrix you are trying to equate to the O matrix is bigger than the Observed matrix following any selection.* Make it smaller...
72. *The matrix you are trying to equate to the expected matrix is not the same size as the expected matrix for that group. The size of the expected matrix for that group is determined by the size of its observed matrix after selection.* Make it the same size.
73. *You have to give NG after CA if the first group is a CALC group.* So do it.
74. *Tut-tut! you are trying to dot-product two matrices that have different dimensions.* This is different from ordinary matrix multiplication after all.
75. *I tried to read another group and hit the end of file instead. Either NG= is wrong in group 1, or your input file has been truncated.* NG is probably wrong.
76. *Look buster, if you want to define your own function. Then please get your matrix formula to define a 1x1 matrix!* See page86

77. *At first I thought you were going to use a function, but then... You didn't put \det, \tr, \exp, \ln, \sqrt, \vd, \d2v, \m2v, \v2s, \v2f, \eval, \evec, \ivec, \ival, \stnd, \vech, \vec, \sin \cos \tan \sinh \cosh \tanh \mult - or any functions that I recognize, so I am confused.. You must have booped somewhere.*
78. *Sorry, I only calculate the determinant of SQUARE matrices.*
79. *Sorry, I only calculate the trace of SQUARE matrices.*
80. *I say, if you use the \EXPonent operator, you must make sure that the exponent is a 1x1 matrix. You won't get this error message.*
81. *I can't equate this matrix to the observed data of that group, because it hasn't got any!*
82. *Hmmm sorry I don't understand this keyword. Check NI= and FU/FI status of data matrices.*
83. *HEY! I thought you were going to say = but where's the =??*
84. *You can only have MA=CM,PM, or KM right now - sorry!*
85. *Pardon my ignorance here, but I don't understand this keyword. You should be using one of the following: CMatrix, PMatrix, KMatrix, ACov_matrix, Raw_data, MEans, SKew, KURtosis, Labels, SElect, or MATrices. Where at least the uppercase letters must be given. Quite possibly, an earlier command screwed up. This is commonly encountered in the middle of a list of numbers if the list is too long. This may be because you have given too many numbers for the type and size of the matrix concerned, or alternatively you may have specified the dimensions of that matrix incorrectly. Note that you should only supply numbers for the modifiable elements of a matrix, which depends heavily on the type of matrix. See Section 4.5 for details on numbers of elements in different types of matrices.*
86. *Imagine this: I'm reading a number and I see a \ character, so I think. I know, it must be \PI or \E BUT then to my surprise I see it is neither. Do be less surprising in your input.*
87. *I'm sorry, I can't write a matrix that doesn't exist to a file. Remember, this matrix has to be defined in this group.*
88. *To output matrices to files, use MX with 1 letter after it (exceptions %E %M %P %V) then an = sign. No spaces or anything else allowed.*
89. *AAAAGH! You can't assign parameters to the raw data vector.*
90. *If you want to fit to the raw data vectors, you must put them in a vector that has 1 row and the columns less than or equal to the number of input variables before selection, if any.*
91. *No, I won't let you do this. It would overwrite the first raw data observation. Go and edit your data instead.*
92. *Uh-oh, attempt to take log of zero or negative value imminent.*
93. *In order to use Maximum Likelihood to raw data, it is necessary to supply both a model for the covariances, and one for the means.*
94. *Sorry, the expected matrix is singular just now.*
95. *Just WHAT is this keyword supposed to mean? You should be using one of the following: MEan_structure, THresholds, COvariances, SPecify, MAtrix, PArAmeter, FIx, FRee, EQual, VAlue, STart, BOundary, OPTions, ENd, OUtput. Where at least the uppercase letters must be given.*
96. *You have tried to convert something that wasn't a vector into a matrix. Please try not to abuse \v2 functions in this way.*
97. *At your starting values, evaluation of the log-likelihood made me take the logarithm of something less than or equal to zero. Please revise the starting values. Nothing for it... change the starting values. This could be a problem if there are some gruesome outliers, in which case you'd have to edit your data... See page 132 for details of how to interpret and respond to the diagnostics printed along with this error message.*
98. *Your boundary constraint refers to a parameter not yet specified.*
99. *You have referred to a non-existent row of a matrix. It's silly mistakes like these that my job as a computer *SO* rewarding. MX has a lousy imagination when it comes to that sort of thing.*
100. *You have referred to a non-existent column of a matrix. There are lots of non-existent columns in Athens and Rome.*
101. *You can't use the keyword Full when reading diagonal weight matrices or means.*
102. *SORRY I don't select DWLS with correlation matrices yet. Try again after midnight? Seriously, I'm sorry about this.*
103. *Error - you seem to have a non-integer value for the type of person. Please check: (1) you have the right pedigree size here (2) you have an integer type identifier for everyone (3) Nothing screwed up in an earlier pedigree. Make sure that you have got your VL file right. Be extra careful about SAS missing values.*
104. *Please, you must tell me the covariance matrix structure in terms of id codes. Use the IC command to do this, sometime after MO and before End.*

105. *There is a variable in this pedigree whose id has not been given in the IC command. If no IC was given a variable who has an id greater than NI is present. The mysterious stranger needs to be identified and deleted.*
106. *Your model does not define the covariance between TWO people with this ID. Of course, by default it won't. You need to use the IC command correctly. See page 44.*
107. *An element of a matrix that you have tried to $\sqrt{}$ is less than zero. Please don't let this happen! This version of MX does not cater for complex numbers - most of the time.*
108. *You tried to convert a vector of the wrong length to a symmetric matrix. Hah, didn't think I'd notice eh?*
109. *I am only prepared to raise the elements of a matrix to the power of a scalar. Please try to ensure the matrix to the right of a $^$ is (1 x 1). Do you have any better ideas? Kroneckerize it or something like that?*
110. *You tried to convert a vector of the wrong length to a FULL square matrix. Silly billy.*
111. *Eigenvalues of square matrices only, please.*
112. *Eigenvectors of square matrices only, please.*
113. *I'm afraid that if you want to fit to raw data you MUST supply models for BOTH means and covariances. You have forgotten a model for the means. You might forget your head if it wasn't attached with lots of sinews etc. Of course, you may have asked for the wrong kind of fit function on the Options line.*
114. *I'm afraid that if you want to fit to raw data you MUST supply models for BOTH means and covariances. You have forgotten a model for the covariances. This is the 783rd time you have made this mistake but you have probably forgotten about the other times. Of course, you may have asked for the wrong kind of fit function on the Options line.*
115. *If you are using Multiple fits, it is impossible to change the matrix formulae - and you can't change boundaries either.*
116. *If you wish to Specify, Pattern, or matrix a matrix, you have to specify the group number **on the same line** BEFORE the Specification, Pattern or Matrix statement.*
117. *Please try *not* to refer to non-existent groups! I don't mind you having fantasies, but there are limits, you know.*
118. *When using the Multiple option you *MUST* use 3 numbers to specify a matrix element: Group #, row # and column #.*
119. *I'm *so* embarrassed. I ran out of workspace.*
120. *To read labels for a matrix, you must use the syntax: LABEL <R or C> Name.*
121. *Labels can't be given for a non-existent matrix Or rather they can, but MX will stop. Actually they can, but then the program stops immediately.*
122. *Labels may not begin with a number because it could confuse me later on.*
123. *Labels have not been provided for the data, but you seem to be using them to select variables. Use numbers or "Give me labels or give me ..."*
124. *It would seem that you are trying to select a variable that you never supplied. I expect that, being human, you made a mistake in the Labels or Select list.*
125. *I can't select a variable that doesn't exist. Make sure that NI is correct or fix the Select list.*
126. *Sorry, you can use covariance structures ONLY in constraint or calculation groups; means not allowed.*
127. *Incorrect element of a lower triangular matrix specified.*
128. *Hey! You must have NInputvars=2 to use contingency tables. A contingency table effectively cross-tabulates two variables, hence NInputvars must be two on the Data line.*
129. *I'm afraid that if you want to fit to contingency tables you MUST supply models for BOTH thresholds and covariances. You have forgotten a model for the thresholds. Are these lapses of memory getting more frequent? Can't remember?? Maybe you need a checkup... Alternatively you may have requested the wrong fit function on the options line.*
130. *I'm afraid that if you want to fit to contingency tables you MUST supply models for BOTH thresholds and covariances. You have forgotten a model for the covariances. Are these lapses of memory getting more frequent? Can't remember?? Maybe you need a checkup... Perhaps you requested the wrong fit function on the options line?*
131. *You must supply a matrix expression for the thresholds that will evaluate to a matrix with 2 rows and with at least as many columns as one less than the number of row categories or the number of column categories, whichever is greater i.e. $\max(\text{nrowcat}-1, \text{ncolcat}-1)$. See page 69 for details about thresholds.*
132. *Sorry, but during optimization I have been asked to calculate a bivariate integral with a correlation of 1 or more. This is very unreasonable of you Please fix your model so that this doesn't happen. Use boundaries or something. Note that the correlation is critical here, not the covariance. The correlation is calculated from the expected covariance matrix (the result of the model or covariance statement) as $\text{cov}_{ij} \div \sqrt{\text{var}_i \text{var}_j}$.*

133. *Yes I will fit to $n \times n$ contingency tables BUT... n must be greater than or equal to 2. I know a $1 \times n$ is feasible but I haven't written the code for it yet, OK?*
134. *If you want me to save or get an MX binary file then you MUST supply a filename on the same line It's just one of those things in life that you have to do.*
135. *We must have misunderstood each other somehow. You can't get expected proportions %P from a group that isn't using contingency tables.*
136. *I think memory is screwed up because Mike Neale has screwed up. Call him on 804 786 8590. Or better still, E-mail him on neale@ruby.vcu.edu or neale@vcuruby (bitnet). Has screwed up or is screwed up?*
137. *Well well well. You would like graphics. If so why don't you put an = after the DR command??? MX likes = signs before filenames. I don't know how it got into this habit.*
138. *To fit to mean structures as well as covariances you should provide *both* observed means and a model for them (as well you know!) I'm going to use the covariances, but the mean - I'm just going to ignore it OK? Watch out for this one if you don't seem to get any action with the means.*
139. *Really I'm very very sorry about this. It is not under my control. Unless of course I was to use a better language than FORTRAN77 I suppose... However enough philosophising, the problem is that we have reached the end of file too soon. Since you are using *format, you should put one case per line. That is to say, there should be NObs lines each with NI variables in a RA data file. Sometimes error messages are not just explicit, they are introspective. How would you like to be a computer program? Could be our species' destiny.*
140. *Really I'm very very sorry about this. It is not under my control. Unless of course I was to use a better language than FORTRAN77 I suppose... However enough philosophy, the problem is that we have reached the end of file too soon. Make sure that your format is OK. Also, remember there should be NObs * NI numbers in your RA data file. See previous error message for sci-fi remark.*
141. *Very funny. Hahaha. You want me to standardize a non-square matrix? Just how am I supposed to do that? If you get any ideas, let me know.*
142. *It is with great sadness that I have to tell you that I couldn't standardize your matrix because the number I'm supposed to divide by is too small. Perhaps you could avoid this problem with boundary constraints. Poor machine, it tried!*
143. *You are in terrible danger. Don't say multiple until the last group. I know I could have just remembered for you, but I'm lazy too! There are only so many hours in the day.*
144. *Sorry, old chap. You can't specify boundary constraints after options. I might remedy this problem one day, but for now just meekly go back and put boundary constraints before the first option line in this group.*
145. *Cough, ahem... can you please give me a matrix that has 1 row and 2 column for the power transformation?? Currently it is only possible to apply a transformation to all variables within each vector. This should be upgraded if there is ever support for MX; call your political representative now to safeguard its future...*
146. *For heaven's sake! Can't you bound your constant so that it is *Greater* than minus the minimum observation??! Really most nursery school children have a good idea why this should be done. Exponentiating (especially for non-integer exponents) numbers that are less than zero is mathematically awkward, requiring complex numbers and so on. To avoid complex arithmetic, whose implications are unclear to me in this context, MX demands that if, say, your minimum observation is -3.1, the constant required would have to be greater than +3.1.*
147. *YIKES! There's something funny about the power function you request. Remember that after PO you should supply 2 numbers. The significance level (alpha) ($0.0 < \alpha < 1$), and the degrees of freedom of the test ($df > 0$). Sometimes NAG chokes if alpha is close to 0 or 1. I can't think why this shouldn't be self-explanatory. The numbers should be on the same line as the Power keyword. Note that Power in this context refers to calculating the statistical power of the study (see page 108).*
148. *I can calculate confidence intervals in the range 0 to 100. Please try to stay within these bounds'. Everyone has their limits, you know.*
149. *Look here buster, the matrix you \muln must have 3 more rows than it does columns.*
150. *There is a problem with the multinormal integral that you tried to compute. See if you can be kinder to me by using bounds.*
151. *Covariance matrices must be computed from sample sizes of at least 1. I suspect that you forgot to put the NObs= parameter on the data line.*
152. *The operation you attempted using ^ is undefined in mathematics in this universe. Try using e.g. \abs() if you can, or go to another universe!*
153. *Look here buster, the matrix you \mnor must have 4 more rows than it does columns.*
154. *Unknown matrix operator encountered!*

155. *Your observed covariance matrix is not positive-definite. Check that you are reading it in the correct format - Full or Symmetric.*
156. *Ooops. Somehow I was expecting a matrix with 4 more rows than columns for the \momnor function. Remember, they should be organized this way: Covariance matrix/Mean vector/Thresholds in terms of standardized units/Selection vector: 1=above, -1=below, 0=not selected/Quadrature parameter 0=default=16; max=64.*
157. *Aha! You have tried to use algebra to create a matrix that already exists. This is strictly illegal in MX. Go directly to Jail. Do not pass go. Do not collect \$200. And make sure you haven't forgotten the End Algebra; statement.*
158. *Hmmm you can't call a matrix this. Not yet. Use single letters (A-Z) for now.*
159. *After the BEGIN keyword I expected to see one of the keywords ALGEBRA or MATRICES. Are you dyslexic? Or am I?*
160. *Well I was trying to find the above character, but even though I looked through the whole file. I could not find it. Perhaps you forgot it?*
161. *You seem to have put two binary operators in a row, which is bad syntax. Might this be a typo? Just possibly?*
162. *I figure that you are trying to redefine something in this multi-group script but you have not used a #define Group = n statement yet so I don't know which group it is you wish to change.*
163. *Oh no you don't. You can't use a #define group statement unless you are (or rather I am) in multiple fit mode.*
164. *Sorry, I don't understand what you are trying to #define.*
165. *While searching for a number, I encountered a string more than 32 characters long. At first, I thought it might be a global variable, but it is probably just your mistake.*
166. **So* sorry! You can't use !@ in the title. It might confuse my front end.*
167. *I was trying to read a number or a #define'd parameter, and although I found a delimiter, I got to the end of the line before I found the number.*
168. *I know this is rather silly of me, but I really need to know both NI= and NO= in order to read the data sensibly. Please look at the DA line.*
169. *Error: file not found: Check spelling and existence of file. Remember that UNIX is case sensitive. Filenames have a maximum of 80 characters including directory.*
170. *Once I saw the begin keyword, I thought, 'Aha I bet this user is going to say algebra or matrices next.' Well I lost my bet. I don't know what you want to begin.*
171. *You seem to be trying to end matrices with something other than 'end matrices;'. It's not that difficult, is it?*
172. *This is a generic error message of no use to you whatsoever. Lots of software has error messages like this, so I thought MX should too. Please contact Mike Neale (neale@ruby.vcu.edu) for help.*
173. *I'm terribly sorry about this old chap. You can't use QQ as a missing data flag. It's Just one of those things.*
174. *Oh boy. There I was trying to read stuff in rectangular format for you. And then I came across a blank record. I suspect a mistake.*
175. *Ker-splat! I ran into some peculiar FORTRAN read error. Check the data file for Suspicious Characters.*
176. *An error has occurred while reading a rectangular file. Make sure that you *don't* have a FORMAT at the beginning and note, I can't read numbers that begin with D, Q or E.*
177. *Ooooooh! Weird one. Your data file seems to be empty.*
- 178.
179. *Sorry, I'm just not ready to save at this point.*
180. *This might seem a bit picky of me, but if you are going to simulate data. I'd like to know HOW MANY cases to simulate. Please give NI=n on the Simulate line, where n is a positive integer. Thank you.*
181. *Now look here. To simulate data you need to have a matrix formula for the Covariances which is *Square*, i.e., rows = columns above.*
182. *Well there I was, all ready to equate all the matrices in this group to those of a previous group, and then you didn't put *which* group on the same line. Try, e.g., Matrices = Group 1. Note that you *must* have a space after the word group.*
183. *Unbalanced parentheses in your formula. I'm not big into Yin & Yan but this is one area that I'd like more balance.*
184. *I can't give you the sort order of this *column vector* because it has more than one column!!*
185. *Partition requires syntax \part(A,B) where B has 4 rows and one column. Somehow you didn't do this right.*
186. *No no no. The second matrix in the list \part(A,B) must have 4 rows and 1 column.*

187. *I'm afraid that you can't use & between matrices that are not conformable. In this case, the number of columns in the first matrix must equal the number of rows in the second matrix, which must be square (rows of b=cols of b).*
188. *Look, how am I supposed to know what these elements outside the dimensions of the matrix are??*
189. *The partition function is tricky, I know. Make sure that the coordinate (2nd) matrix has been initialized FIRST. See the example partit.mx for details on how to do this.*
190. *OK wise guy that's far enough! The group you referenced with %O doesn't have an observed covariance matrix!*
191. *The matrices you wish to divide with % are not conformable. The number of rows in matrix 1 must be the same as the number of rows in matrix 2, *and* the number of columns in matrix 1 must be the same as the number of columns in matrix 2.*
192. *I believe you read in the inverse of a weight matrix, sir? In that case you can't use select variables, because it defeats the point of saving time by pre-inverting.*
193. *To use the computed matrix type, you have to put = M I on the same line, where M is a matrix and I is an earlier group. I'm not psychic. How am I supposed to know which computed matrix you want it to equal?*
194. *Hang on a minute! You can *only* use the computed matrix type to refer to matrices generated in a Begin Algebra section.*
195. *Yoo-hoo! You're supposed to a letter here...*
196. *Gadzooks! You didn't supply a compute statement in that group. Therefore, I can't make this matrix equal to the %E of it.*
197. *Huh? I don't understand your optional command line parameters. Syntax should be e.g.,: mx -f -h -k 100 myfile.mx myfile.mxo where f denotes frontend, h requests html, and k is workspace. Note: -f implies reading from keyboard and writing to screen.*
198. *You must put the filename on the same line when using !@get,!@put or !@exist.*
199. *Huh?*
200. *File exists; use !@PUT! to overwrite it.*

Some of these error messages are a little informal. I apologize. I'm terribly terribly sorry and I won't do it again.

What I am really sorry about is if MX gives you the wrong error message. This is quite rare, but occasionally it is possible to screw up memory, and one of the sensitive areas is the matrix formula. When this has occurred, you may see

"Dump of formula being calculated"

while the program is running. It is important to check the formulae, but if they seem ok, it's time to email technical support. One untrapped source is if you say

```
Start .5 A 1 2 3 to A 2 2 3
```

in which case everything between the memory addresses of A of group 1 and A of group 2 gets overwritten with .5. A little care can go a long way; so can a little more foolproof programming which I shall try to provide as soon as I can. Please let me know of any nonsensical error messages that you get; elucidation is prerequisite for elimination.

Appendix C Introduction to Matrices

C.1 The Concept of a Matrix

A matrix is a table of numbers or symbols laid out in *rows* and *columns*, e.g.

$$\begin{pmatrix} 1 & 4 \\ 2 & 5 \\ 3 & 6 \end{pmatrix} \quad \text{or} \quad \begin{pmatrix} \alpha_{11} & \alpha_{12} & \alpha_{13} \\ \alpha_{21} & \alpha_{22} & \alpha_{23} \\ \alpha_{31} & \alpha_{32} & \alpha_{33} \end{pmatrix}$$

The table is enclosed in () or [] in most texts.

It is conventional to specify the configuration of the matrix in terms of Rows×Columns and these are its *dimensions*. Thus the first matrix above is of dimensions 3 by 2 and the second is a 3×3 *square* matrix.

The most common occurrence of matrices in behavioral sciences is the *data matrix* where the *rows are subjects* and the *columns are measures*. e.g.

$$\begin{array}{cc} \text{Wt.} & \text{Ht.} \\ S_1 & \left[\begin{array}{c} 50 \\ 20 \end{array} \right] \\ S_2 & \left[\begin{array}{c} 100 \\ 40 \end{array} \right] \\ S_3 & \left[\begin{array}{c} 150 \\ 60 \end{array} \right] \\ S_4 & \left[\begin{array}{c} 200 \\ 80 \end{array} \right] \end{array}$$

It is convenient to let a single letter symbolize a matrix. This is written in UPPERCASE **boldface**.

Thus we might say that our data matrix is **A**, which in handwriting we would underline with either a straight or a wavy line. Sometimes a matrix may be written ${}_4\mathbf{A}_2$ to specify its dimensions. When a matrix consists of a single number, it is called a *scalar*; when it consists of single column (row) of numbers it is called a column (row) *vector*. Vectors are normally represented as a **bold** lowercase. Thus the weights of our four subjects are

$$\begin{bmatrix} 50 \\ 100 \\ 150 \\ 200 \end{bmatrix} = \mathbf{a}$$

C.2 Matrix Algebra

Matrix algebra defines a set of operations that may be performed on matrices. These operations include addition, subtraction, multiplication, inversion (multiplication by the inverse is similar to division) and transposition.

Transposition

A matrix is transposed when the rows are written as columns and the columns are written as rows. This operation is denoted by writing \mathbf{A}' or \mathbf{A}^T . In our example,

$$\mathbf{A}' = \begin{pmatrix} 50 & 100 & 150 & 200 \\ 20 & 40 & 60 & 80 \end{pmatrix}$$

a row vector is usually written

$$\mathbf{a}' = (50 \ 100 \ 150 \ 200)$$

Clearly, $(\mathbf{A}')' = \mathbf{A}$.

The MX script would look as follows:

```
Title: transpose of matrix A
Calculation NGroups=1
```

```
Begin Matrices;
  A Full 4 2
End Matrices;
Matrix A
  50 20
  100 40
  150 60
  200 80
```

```
Begin Algebra;
  B= A';
End Algebra;
End
```

Matrix Addition and Subtraction

Matrices may be *added* and to do so they must be of the *same dimension*. They are then said to be *conformable for addition*. Each element in the first matrix is added to the corresponding element in the second matrix to form the same element in the solution, e.g.

$$\begin{pmatrix} 1 & 4 \\ 2 & 5 \\ 3 & 6 \end{pmatrix} + \begin{pmatrix} 8 & 11 \\ 9 & 12 \\ 10 & 13 \end{pmatrix} = \begin{pmatrix} 9 & 15 \\ 11 & 17 \\ 13 & 19 \end{pmatrix}$$

or symbolically, $\mathbf{A} + \mathbf{B} = \mathbf{C}$.

You *cannot* add

$$\begin{pmatrix} 1 & 4 \\ 2 & 5 \\ 3 & 6 \end{pmatrix} + \begin{pmatrix} 8 & 10 \\ 9 & 11 \end{pmatrix}$$

Subtraction works in the same way as addition, e.g.

$$\begin{pmatrix} 1 & 4 \\ 2 & 5 \\ 3 & 6 \end{pmatrix} - \begin{pmatrix} 2 & 5 \\ 2 & 5 \\ 2 & 5 \end{pmatrix} = \begin{pmatrix} -1 & -1 \\ 0 & 0 \\ 1 & 1 \end{pmatrix}$$

which is written $\mathbf{A} - \mathbf{B} = \mathbf{C}$.

Matrix Multiplication

Matrices *may be multiplied* and to do so they must be *conformable for multiplication*. This means that *adjacent columns and rows must be of the same order*. For example, the matrix product ${}_3\mathbf{A}_2 \times {}_2\mathbf{B}_2$ may be calculated; the result is a 3×2 matrix. In general, if we multiply two matrices ${}_i\mathbf{A}_j \times {}_j\mathbf{B}_k$, the result will be of order $i \times k$.

Matrix multiplication involves calculating a *sum of cross products* among *rows of the first matrix* and *columns of the second matrix* in all possible combinations, e.g.

$$\begin{pmatrix} 1 & 4 \\ 2 & 5 \\ 3 & 6 \end{pmatrix} \begin{pmatrix} 1 & 3 \\ 2 & 4 \end{pmatrix} = \begin{pmatrix} 1 \times 1 + 4 \times 2 & 1 \times 3 + 4 \times 4 \\ 2 \times 1 + 5 \times 2 & 2 \times 3 + 5 \times 4 \\ 3 \times 1 + 6 \times 2 & 3 \times 3 + 6 \times 4 \end{pmatrix} = \begin{pmatrix} 9 & 19 \\ 12 & 26 \\ 15 & 33 \end{pmatrix}$$

This is written $\mathbf{AB} = \mathbf{C}$.

The only exception to the above rule is multiplication by a *single number* called a scalar. Thus for example,

$$2 \begin{pmatrix} 1 & 4 \\ 2 & 5 \\ 3 & 6 \end{pmatrix} = \begin{pmatrix} 2 & 8 \\ 4 & 10 \\ 6 & 12 \end{pmatrix}$$

by convention we write this $2 \mathbf{A}$.

It is not possible to use this convention directly in \mathbf{Mx} ; however, it is possible to define a 1×1 matrix with the constant 2.0 as the sole element, and use the kronecker product.

The simplest example of matrix multiplication is to multiply a vector by itself. If we premultiply a column vector by its transpose, the result is a scalar called the *inner product*. For example, if

$$\mathbf{a}' = (1 \ 2 \ 3)$$

then the inner product is

$$\mathbf{a}'\mathbf{a} = (1 \ 2 \ 3) \begin{pmatrix} 1 \\ 2 \\ 3 \end{pmatrix} = 1^2 + 2^2 + 3^2 = 14$$

which is the sum of the squares of the elements of the vector \mathbf{A} . This has a simple graphical representation when \mathbf{A} is of dimension 2×1 (see Figure C.1).

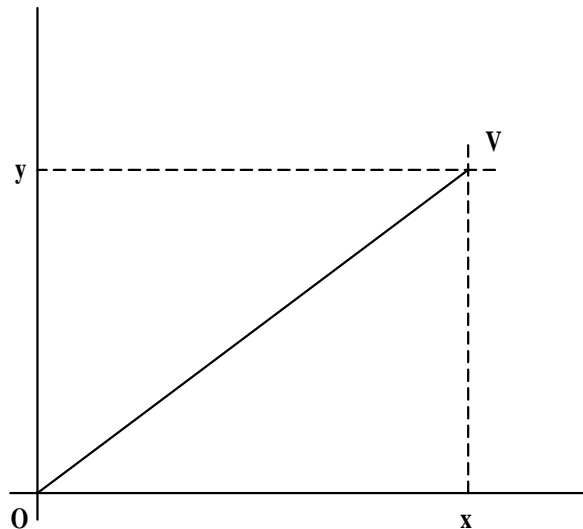

Figure C.1 Graphical representation of the inner product $\mathbf{a}'\mathbf{a}$ of a (2×1) vector \mathbf{a} , with $\mathbf{a}'=(xy)$. By Pythagoras' theorem, the distance of the point V from the origin O is $\sqrt{x^2+y^2}$, which is the square root of the inner product of the vector.

Multiplication Exercises

Try these exercises either by hand, or using MX, or both, as suits your needs.

Let

$$\mathbf{A} = \begin{pmatrix} 3 & 6 \\ 2 & 1 \end{pmatrix}, \quad \mathbf{B} = \begin{pmatrix} 1 & 0 & 3 & 2 \\ 0 & -1 & -1 & 1 \end{pmatrix}$$

1. Form **AB**.
2. Form **BA**. (Careful, this might be a trick question!)

Let

$$\mathbf{C} = \begin{pmatrix} 3 & 6 \\ 2 & 1 \end{pmatrix}, \quad \mathbf{D} = \begin{pmatrix} 1 & 2 \\ 3 & 4 \end{pmatrix}$$

1. Form **CD**.
2. Form **DC**.
3. In ordinary algebra, multiplication is *commutative*, i.e. $xy=yx$. In general, is matrix multiplication commutative?
4. Show for two (preferably non-trivial) matrices conformable for multiplication that **$(\mathbf{AB})' = \mathbf{B}'\mathbf{A}'$**

Let

$$\mathbf{E}' = \begin{pmatrix} 1 & 0 & 3 \\ 1 & 2 & 1 \end{pmatrix}$$

1. Form **E(C+D)**.
2. Form **EC + ED**.
3. In ordinary algebra, multiplication is *distributive*, i.e. $x(y+z) = xy+xz$. In general, is matrix multiplication distributive?

C.3 Equations in Matrix Algebra

Matrix algebra provides a very convenient short hand for writing sets of equations. For example, the pair of *simultaneous equations*

$$\begin{aligned}y_1 &= 2x_1 + 3x_2 \\ y_2 &= x_1 + x_2\end{aligned}$$

may be written

$$\mathbf{y}' = \mathbf{Ax}$$

i.e.

$$\begin{pmatrix} y_1 \\ y_2 \end{pmatrix} = \begin{pmatrix} 2 & 3 \\ 1 & 1 \end{pmatrix} \begin{pmatrix} x_1 \\ x_2 \end{pmatrix}$$

Also if we have the following pair of equations:

$$\begin{aligned}\mathbf{y} &= \mathbf{Ax} \\ \mathbf{x} &= \mathbf{Bz}\end{aligned}$$

Then

$$\begin{aligned}\mathbf{y} &= \mathbf{A(Bz)} \\ &= \mathbf{ABz} \\ &= \mathbf{Cz}\end{aligned}$$

where $\mathbf{C=AB}$. This is very convenient notation compared with direct substitution. Structural equations are written in this general form, i.e. "*Real variables (y) = matrix \times hypothetical variables.*"

To show the simplicity of the matrix notation, consider the following equations:

$$\begin{aligned}y_1 &= 2x_1 + 3x_2 \\ y_2 &= x_1 + x_2 \\ x_1 &= z_1 + z_2 \\ x_2 &= z_1 - z_2\end{aligned}$$

Then we have

$$\begin{aligned}
 y_1 &= 2(z_1 + z_2) + 3(z_1 - z_2) \\
 &= 5z_1 - z_2 \\
 y_2 &= (z_1 + z_2) + (z_1 - z_2) \\
 &= 2z_1 + 0
 \end{aligned}$$

From $\mathbf{y}=\mathbf{ABz}$, where

$$\mathbf{A} = \begin{pmatrix} 2 & 3 \\ 1 & 1 \end{pmatrix}, \quad \mathbf{B} = \begin{pmatrix} 1 & 1 \\ 1 & -1 \end{pmatrix}$$

and

$$\mathbf{AB} = \begin{pmatrix} 5 & -1 \\ 2 & 0 \end{pmatrix},$$

or

$$\begin{aligned}
 y_1 &= 5z_1 - z_2 \\
 y_2 &= 2z_1
 \end{aligned}$$

C.4 Calculation of Covariance Matrix from Data Matrix

Suppose we have a data matrix \mathbf{A} with rows corresponding to subjects and columns corresponding to variables. We can calculate a mean for each variable and replace the data matrix with a matrix of *deviations from the mean*. That is, each element a_{ij} is replaced by $a_{ij} - \mu_j$ where μ_j is the mean of the j^{th} variable. Let us call the new matrix \mathbf{X} . The covariance matrix is then simply calculated as:

$$\frac{1}{N-1} \mathbf{X}'\mathbf{X}$$

where N is the number of subjects.

For example, suppose we have the following data:

X	Y	$X - \bar{X}$	$Y - \bar{Y}$
1	2	-2	-4
2	8	-1	2
3	6	0	0
4	4	1	-2
5	10	2	4

so the matrix of deviations from the mean is

$$\mathbf{X} = \begin{pmatrix} -2 & -4 \\ -1 & 2 \\ 0 & 0 \\ 1 & -2 \\ 2 & 4 \end{pmatrix}$$

and therefore the covariance matrix of the observations is

$$\begin{aligned} \frac{1}{N-1} \mathbf{X}'\mathbf{X} &= \frac{1}{4} \begin{pmatrix} -2 & -1 & 0 & 1 & 2 \\ -4 & 2 & 0 & -2 & 4 \end{pmatrix} \begin{pmatrix} -2 & -4 \\ -1 & 2 \\ 0 & 0 \\ 1 & -2 \\ 2 & 4 \end{pmatrix} \\ &= \frac{1}{4} \begin{pmatrix} 10 & 12 \\ 12 & 40 \end{pmatrix} \\ &= \begin{pmatrix} 2.5 & 3.0 \\ 3.0 & 10.0 \end{pmatrix} \\ &= \begin{pmatrix} S_x^2 & S_{xy} \\ S_{xy} & S_y^2 \end{pmatrix} \end{aligned}$$

The correlation is

$$\frac{S_{xy}}{\sqrt{S_x^2 S_y^2}} = \frac{S_{xy}}{S_x S_y}$$

In general, a correlation matrix may be calculated from a covariance matrix by pre- and post-multiplying the covariance matrix by a *diagonal matrix* \mathbf{D} in which each diagonal element d_{ii} is $1/S_i$, i.e. the reciprocal of the standard deviation for that variable. Thus in our two variable example, we have:

$$\begin{pmatrix} \frac{1}{S_x} & 0 \\ 0 & \frac{1}{S_y} \end{pmatrix} \begin{pmatrix} S_x^2 & S_{xy} \\ S_{xy} & S_y^2 \end{pmatrix} \begin{pmatrix} \frac{1}{S_x} & 0 \\ 0 & \frac{1}{S_y} \end{pmatrix} = \begin{pmatrix} 1 & R_{xy} \\ R_{xy} & 1 \end{pmatrix}$$

Transformations of Data Matrices

Matrix algebra provides a natural notation for *transformations*. If we premultiply the matrix \mathbf{B}_j by another, say ${}_k\mathbf{T}_i$, then the rows of \mathbf{T} describe linear combinations of the rows of \mathbf{B} . The resulting matrix will therefore consist of k rows corresponding to the linear transformations of the rows of \mathbf{B} described by the rows of \mathbf{T} . A very simple example of this is premultiplication by the *identity matrix* (written \mathbf{I}), which merely has 1's on the leading diagonal and zeroes everywhere else. Thus the transformation described by the first row may be written as 'multiply the first row by 1 and add zero times the other rows.' In the second row, we have 'multiply the second row by 1 and add zero times the other rows,' and so the identity matrix transforms the matrix \mathbf{B} into the same matrix. For a less trivial example, let our data matrix be \mathbf{X} , then

$$\mathbf{X}' = \begin{pmatrix} -2 & -1 & 0 & 1 & 2 \\ -4 & 2 & 0 & -2 & 4 \end{pmatrix}$$

and let

$$\mathbf{T} = \begin{pmatrix} 1 & 1 \\ 1 & -1 \end{pmatrix}$$

then

$$\begin{aligned} \mathbf{Y}' &= \mathbf{TX}' \\ &= \begin{pmatrix} -6 & 1 & 0 & -1 & 6 \\ 2 & -3 & 0 & 3 & -2 \end{pmatrix} \end{aligned}$$

In this case, the transformation matrix specifies two transformations of the data: the first row defines the sum of the two variates, and the second row defines the difference (row 1 - row 2). In the above, we have applied the transformation to the raw data, but for these linear transformations it is easy to apply the transformation to the covariance matrix. The covariance matrix of the transformed variates is

$$\begin{aligned} \frac{1}{N-1}\mathbf{Y}'\mathbf{Y} &= \frac{1}{N-1}(\mathbf{TX}')(\mathbf{TX}')' \\ &= \frac{1}{N-1}\mathbf{TX}'\mathbf{XT}' \\ &= \mathbf{TV}_x\mathbf{T}' \end{aligned}$$

which is a useful result, meaning that linear transformations may be applied directly to the covariance matrix, instead of going to the trouble of transforming all the raw data and recalculating the covariance matrix.

Determinant of a Matrix

For a square matrix \mathbf{A} we may calculate a scalar called the *determinant* which we write as $|\mathbf{A}|$. In the case of a 2×2 matrix, this quantity is calculated as

$$|\mathbf{A}| = a_{11}a_{22} - a_{12}a_{21}.$$

The determinant has an interesting geometric representation. For example, consider two standardized variables that correlate r . This situation may be represented graphically by drawing two vectors, each of length 1.0, having the same origin and an angle cosine r between them (see figure C.2). It can be shown (i.e. this is a toughie that involves symmetric square root decomposition of matrices, eigenvalues etc. that I'm not going to do here) that the area of the triangle OV_1V_2 is $.5\sqrt{|\mathbf{A}|}$. Thus as the correlation r increases, the angle between the lines decreases, the area decreases and *the determinant decreases*. For two variables that correlate perfectly, the determinant of the correlation (or covariance) matrix is zero. For larger numbers of variables, the determinant is a simple function of the hypervolume in n -space; if any single pair of variables correlates perfectly then the determinant is zero. In addition, if one of the variables is a linear combination of the others, the determinant will be zero.

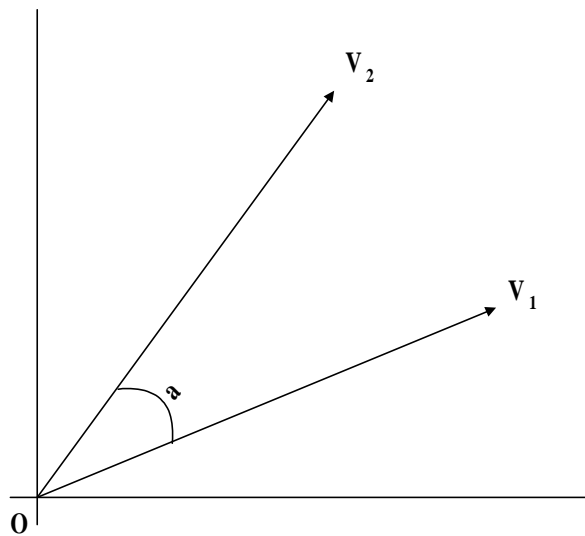

Figure C.2 Geometric representation of the determinant of a matrix. The angle between the vectors is the cosine of the correlation between two variables, so the determinant is given by twice the area of the triangle OV_1V_2 .

To calculate the determinant of larger matrices, we employ the concept of a *cofactor*. If we delete row i and column j from an $n \times n$ matrix, then the determinant of the remaining matrix is called the *minor* of element a_{ij} . The cofactor, written A_{ij} is simply:

$$A_{ij} = (-1)^{i+j} \text{ minor } a_{ij}$$

The determinant of the matrix \mathbf{A} may be calculated as

$$|\mathbf{A}| = \sum_{i=1}^n a_{ij} A_{ij}$$

where n is the order of \mathbf{A} .

The determinant of a matrix is related to the concept of *definiteness* of a matrix. In general, for a null column vector \mathbf{x} , the quadratic form $\mathbf{x}'\mathbf{A}\mathbf{x}$ is always zero. For some matrices, this quadratic is zero *only* if \mathbf{x} is the null vector. If $\mathbf{x}'\mathbf{A}\mathbf{x} > 0$ for all non-null vectors \mathbf{x} then we say that the matrix is *positive definite*. Conversely, if $\mathbf{x}'\mathbf{A}\mathbf{x} < 0$ for all non-null \mathbf{x} , we say that the matrix is *negative definite*. However, if we can find some non-null \mathbf{x} such that $\mathbf{x}'\mathbf{A}\mathbf{x} = 0$ then the matrix is said to be *singular*, and its determinant is zero. As long as no two variables are perfectly correlated, and there are more subjects than measures, a covariance matrix calculated from data on random variables will be *positive definite*. MX will complain (and rightly so!) if it is given a covariance matrix that is not positive definite. The determinant of the covariance matrix can be helpful when there are problems with model-fitting that seem to originate with the data. However, it is possible to have a matrix with a positive determinant yet which is negative definite (consider $-\mathbf{I}$ with an even number of rows), so the determinant is not an adequate diagnostic. Instead we note that all the eigenvalues of a positive definite matrix are greater than zero. Eigenvalues and eigenvectors may be obtained from software packages and the numerical libraries listed above¹¹.

Inverse of a Matrix

Just as there are many uses for the operation of division in ordinary algebra, there are many valuable applications of the inverse of a matrix. We write the inverse of the matrix \mathbf{A} as \mathbf{A}^{-1} , and one of the most important results is that

$$\mathbf{A}\mathbf{A}^{-1} = \mathbf{I}$$

where \mathbf{I} is the identity matrix. In this case, the multiplication operation is commutative, so it is also true that

$$\mathbf{A}^{-1}\mathbf{A} = \mathbf{I}$$

There are many computer programs available for inverting matrices. Some routines are general, but there are often faster routines available if the program is given some information about the matrix, for example whether it is symmetric, positive definite, triangular or diagonal. Here we describe one general method that everyone should use at least once in their lives for at least a 3×3 matrix.

¹¹ Those readers wishing to know more about the uses of eigenvalues and eigenvectors may consult Searle (1982) or any general text on matrix algebra.

Procedure for Inversion of a General Matrix

In order to invert a matrix, the following four steps can be used:

1. Find the determinant
2. Set up the matrix of cofactors
3. Transpose
4. Divide by the determinant

For example, the matrix

$$\mathbf{A} = \begin{pmatrix} 1 & 2 \\ 1 & 5 \end{pmatrix}$$

1.

$$|\mathbf{A}| = (1 \times 5) - (2 \times 1) = 3$$

2.

$$\begin{aligned} A_{ij} &= \begin{bmatrix} (-1)^2 \times 5 & (-1)^3 \times 1 \\ (-1)^3 \times 2 & (-1)^4 \times 1 \end{bmatrix} \\ &= \begin{pmatrix} 5 & -1 \\ -2 & 1 \end{pmatrix} \end{aligned}$$

3.

$$A'_{ij} = \begin{pmatrix} 5 & -2 \\ -1 & 1 \end{pmatrix}$$

4.

$$\begin{aligned} \mathbf{A}^{-1} &= \frac{1}{3} \begin{pmatrix} 5 & -2 \\ -1 & 1 \end{pmatrix} \\ &= \begin{pmatrix} \frac{5}{3} & \frac{-2}{3} \\ \frac{-1}{3} & \frac{1}{3} \end{pmatrix} \end{aligned}$$

To verify this, we can multiply $\mathbf{A}\mathbf{A}^{-1}$ to obtain the identity matrix:

$$\frac{1}{3} \begin{pmatrix} 5 & -2 \\ -1 & 1 \end{pmatrix} \begin{pmatrix} 1 & 2 \\ 1 & 5 \end{pmatrix} = \frac{1}{3} \begin{pmatrix} 3 & 0 \\ 0 & 3 \end{pmatrix} = \begin{pmatrix} 1 & 0 \\ 0 & 1 \end{pmatrix}$$

The result that $\mathbf{A}\mathbf{A}^{-1} = \mathbf{I}$ may be used to solve the pair of simultaneous equations:

$$\begin{aligned} x_1 + 2x_2 &= 8 \\ x_1 + 5x_2 &= 17 \end{aligned}$$

which may be written

$$\begin{pmatrix} 1 & 2 \\ 1 & 5 \end{pmatrix} \begin{pmatrix} x_1 \\ x_2 \end{pmatrix} = \begin{pmatrix} 8 \\ 17 \end{pmatrix}$$

i.e.

$$\mathbf{A}\mathbf{x} = \mathbf{y}$$

premultiplying both sides by the inverse of \mathbf{A} , we have

$$\begin{aligned} \mathbf{A}^{-1}\mathbf{A}\mathbf{x} &= \mathbf{A}^{-1}\mathbf{y} \\ \mathbf{x} &= \mathbf{A}^{-1}\mathbf{y} \\ &= \frac{1}{3} \begin{pmatrix} 5 & -2 \\ -1 & 1 \end{pmatrix} \begin{pmatrix} 8 \\ 17 \end{pmatrix} \\ &= \frac{1}{3} \begin{pmatrix} 6 \\ 9 \end{pmatrix} \\ &= \begin{pmatrix} 2 \\ 3 \end{pmatrix} \end{aligned}$$

which may be verified by substitution.

For a larger matrix it is more tedious to compute the inverse. Let us consider the matrix

$$\mathbf{A} = \begin{pmatrix} 1 & 1 & 0 \\ 1 & 0 & 1 \\ 1 & -1 & 0 \end{pmatrix}$$

1. The determinant is

$$\begin{aligned}
 |\mathbf{A}| &= +1 \begin{vmatrix} 0 & 1 \\ -1 & 0 \end{vmatrix} -1 \begin{vmatrix} 1 & 1 \\ 1 & 0 \end{vmatrix} +0 \begin{vmatrix} 1 & 0 \\ 1 & -1 \end{vmatrix} \\
 &= +1+1+0 \\
 &= 2
 \end{aligned}$$

2. The matrix of cofactors is:

$$\begin{aligned}
 A_{ij} &= \begin{bmatrix} + \begin{vmatrix} 0 & 1 \\ -1 & 0 \end{vmatrix} & - \begin{vmatrix} 1 & 1 \\ 1 & 0 \end{vmatrix} & + \begin{vmatrix} 1 & 0 \\ 1 & -1 \end{vmatrix} \\
 - \begin{vmatrix} 1 & 0 \\ -1 & 0 \end{vmatrix} & + \begin{vmatrix} 1 & 0 \\ 1 & 0 \end{vmatrix} & - \begin{vmatrix} 1 & 1 \\ 1 & -1 \end{vmatrix} \\
 + \begin{vmatrix} 1 & 0 \\ 0 & 1 \end{vmatrix} & - \begin{vmatrix} 1 & 0 \\ 1 & 1 \end{vmatrix} & + \begin{vmatrix} 1 & 1 \\ 1 & 0 \end{vmatrix} \end{bmatrix} \\
 &= \begin{pmatrix} 1 & 1 & -1 \\ 0 & 0 & 2 \\ 1 & -1 & -1 \end{pmatrix}
 \end{aligned}$$

The transpose is

$$A'_{ij} = \begin{pmatrix} 1 & 0 & 1 \\ 1 & 0 & -1 \\ -1 & 2 & -1 \end{pmatrix}$$

Dividing by the determinant, we have

$$\mathbf{A}^{-1} = \frac{1}{2} \begin{pmatrix} 1 & 0 & 1 \\ 1 & 0 & -1 \\ -1 & 2 & -1 \end{pmatrix} = \begin{pmatrix} .5 & 0 & .5 \\ .5 & 0 & -.5 \\ -.5 & 1 & -.5 \end{pmatrix}$$

which may be verified by multiplication with \mathbf{A} to obtain the identity matrix.

Appendix D Reciprocal Causation

Consider the Path Diagram in Figure D.1.

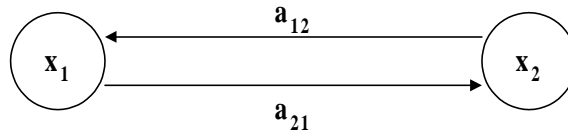

Figure D.1 Feedback loop between two variables, x_1 and x_2 .

This shows a feedback loop between two internal variables, which we call x variables. The total variance of x_1 and x_2 is the sum of the infinite geometric series:

$$a_{21}a_{12} + a_{21}^2a_{12}^2 + a_{21}^3a_{12}^3 \dots$$

It is simple to show that if $|a_{21}a_{12}| < 1$ then the series converges. Let the sum of the series of n terms be called S_n , and let $a_{12}a_{21} = r$. Then

$$S_n = r + r^2 + r^3 + \dots + r^n$$

$$rS_n = r^2 + r^3 + \dots + r^n + r^{n+1}$$

Thus the difference between these two equations is:

$$(1 - r)S_n = r - r^{n+1}$$

and so

$$S_n = \frac{r - r^{n+1}}{1 - r}$$

which as n gets large tends to

$$S_n = \frac{r}{1 - r}$$

$$= \frac{1}{1 - r} - \frac{1 - r}{1 - r}$$

$$= \frac{1}{1 - r} - 1$$

$$= \frac{1}{1 - a_{12}a_{21}} - 1$$

This formula generalizes to the case of a matrix of such effects between more than a pair of variables (Jöreskog & Sörbom, 1989). In general

$$\mathbf{A} + \mathbf{A}^2 + \mathbf{A}^3 + \dots = (\mathbf{I} - \mathbf{A})^{-1} - \mathbf{I}$$

Another way to see this formulation is directly from the structural equations. Figure D.2 shows a multivariate path diagram of a structural equation model, where \mathbf{x} variables are caused by a set of independent variables, \mathbf{y} . In addition, the \mathbf{x} variables may cause each other, hence the unidirectional arrow from \mathbf{x} to itself.

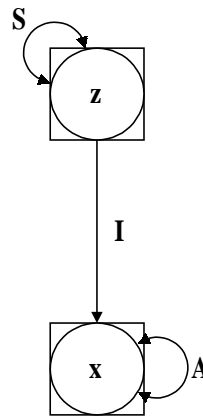

Figure D.2 Structural equation model for \mathbf{x} variables

Algebraically, the model for the \mathbf{x} variables is:

$$\begin{aligned}\mathbf{x} &= \mathbf{Ax} + \mathbf{Iz} \\ &= \mathbf{Ax} + \mathbf{z}\end{aligned}$$

Here \mathbf{x} appears on both sides of the equation, and we want it solely in terms of the other variables in the model. Hence

$$\begin{aligned}\mathbf{x} - \mathbf{Ax} &= \mathbf{z} \\ (\mathbf{I} - \mathbf{A})\mathbf{x} &= \mathbf{z} \\ (\mathbf{I} - \mathbf{A})^{-1}(\mathbf{I} - \mathbf{A})\mathbf{x} &= (\mathbf{I} - \mathbf{A})^{-1}\mathbf{z} \\ \mathbf{x} &= (\mathbf{I} - \mathbf{A})^{-1}\mathbf{z}\end{aligned}$$

so

$$\begin{aligned}\mathbf{xx}' &= (\mathbf{I} - \mathbf{A})^{-1}\mathbf{z}(\mathbf{I} - \mathbf{A})^{-1}\mathbf{z}' \\ &= (\mathbf{I} - \mathbf{A})^{-1}\mathbf{zz}'(\mathbf{I} - \mathbf{A})^{-1'} \\ &= (\mathbf{I} - \mathbf{A})^{-1}\mathbf{S}(\mathbf{I} - \mathbf{A})^{-1'}\end{aligned}$$

This gives a general expression for all variables in a model, both latent and observed. We usually want to predict the covariance between the observed variables only, so that this can

be compared with (“fitted to”) the data. A slight addition to the model is needed to filter the observed variables from the set of all variables (see figure D.3).

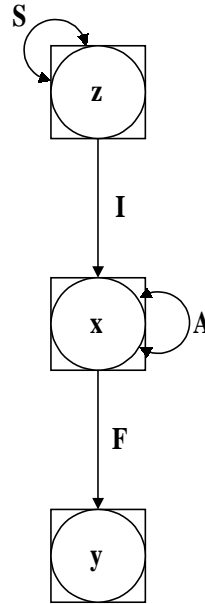

Figure D.3 Structural equation model for y variables

The algebra for the covariance of the observed variables, **y**, is very similar.

$$\begin{aligned} \mathbf{y} &= \mathbf{F}\mathbf{x} \\ &= \mathbf{F}(\mathbf{I} - \mathbf{A})^{-1}\mathbf{z} \end{aligned}$$

so

$$\begin{aligned} \mathbf{y}\mathbf{y}' &= \mathbf{F}(\mathbf{I} - \mathbf{A})^{-1}\mathbf{z}(\mathbf{F}(\mathbf{I} - \mathbf{A})^{-1}\mathbf{z})' \\ &= \mathbf{F}(\mathbf{I} - \mathbf{A})^{-1}\mathbf{z}\mathbf{z}'(\mathbf{I} - \mathbf{A})^{-1'}\mathbf{F}' \\ &= \mathbf{F}(\mathbf{I} - \mathbf{A})^{-1}\mathbf{S}(\mathbf{I} - \mathbf{A})^{-1'}\mathbf{F}' \end{aligned}$$

This model can efficiently and elegantly be specified in MX using the formula:

$$\mathbf{F} \& ((\mathbf{I} - \mathbf{A}) \sim \mathbf{S})$$

which invokes the quadratic operator & (see p. 57).

Appendix E Frequently Asked Questions

Here is a list of some of the frequently asked questions about MX GUI.

- *Q. My job is taking a long time to run. How can I see what's happening?* A. If you are running a job on the local PC, then you can double click on the MXE icon which will give a display of the progress of the optimization. Every 20 iterations the value of the fit function will be updated. If you are running on a Unix host, then there isn't much that can be done, except to log in to the machine. If you have used Option NAG=10 DB=1 then you could view (e.g. using more or tail) the end of the NAGDUMP.OUT file for the latest set of parameter estimates and fit function.
- *Q. What does 'Appears OK' mean as a fit result? What about the other codes?* A. Appears OK means that optimization seems to be successful. Optimization is not an exact science so we can't be 100% sure that a global optimum has been found. The other codes and what you should do about them are shown in Table~\ref{tab:optcodes} in this document.
- *Q. How can I learn more about the MX script language?* A. Chapters ## and the quick reference chart are the best place to learn the language, with the possible exception of attending a course. To date most MX courses have concerned genetic models, although some non-genetic courses have been run at the University of Southern California and The University of Arizona. Future courses will be announced on the MX web page <http://views.vcu.edu/mx>.
- *Q. Help! My diagram has disappeared in the window when I was zooming. How do I get it back?* A. Press the zoomundo button .
- *Q. How do I select a different browser or text file viewer?* A. Select Preferences|Select Test Viewer or Preferences|Select HTML Viewer from the menu bar.
- *Q. How do I work with contingency table data in the GUI?* A. Unfortunately it is not possible to model contingency table data with the GUI at this time. It is possible to draw a diagram for two observed variables (leave them unmapped) and then hit To Script to build a basic script from a two-variable model. Then edit this script to replace the CMatrix with CTable data and add a model for the thresholds in the script itself. This does at least avoid the scary part of specifying the structural equation model with matrix algebra. We hope to add contingency table modeling in the future.

References

- Aitken, A.C. (1934). Note on selection from a multivariate normal population. *Proceedings of the Edinburgh Mathematical Society B* **4**:106-110.
- Aitken, A.C. (1934-35). On least squares and the linear combination of observations. *Proceedings of the Royal Society of Edinburgh* **55**:42-48.
- Akaike, H. (1987). Factor analysis and AIC. *Psychometrika* **52**:317-332.
- Bentler, P.M. (1989). *EQS Structural Equations Program Manual*. Los Angeles: BMDP.
- Bentler, P.M. and Bonett, D.G. (1980). Significance tests and goodness of fit in the analysis of covariance structures. *Psychological Bulletin* **88**: 588-606.
- Bollen, K.A. (1992). *Structural Equations with Latent Variables*. New York: Wiley.
- Browne, M.W. (1974). Generalized least squares estimators in the analysis of Covariance structures. *South African Statistical Journal* **8**:1-24.
- Browne, M.W. (1982). Covariance structures. In D.M. Hawkins (ed.): *Topics in applied multivariate analysis*. Cambridge: Cambridge University Press.
- Browne, M.W. (1984). Asymptotically distribution-free methods for the analysis of Covariance structures. *British Journal of Mathematical and Statistical Psychology* **37**:1-21.
- Browne, M.W. and Cudeck, R. (1990). Single sample cross-validation indices for Covariance structures. *Multivariate Behavioral Research* **24**:445-455.
- Bryk, A.S. & Raudenbush, S.W. (1992) *Hierarchical Linear Models: Applications and data analysis methods*. Newbury Park: Sage Press.
- Cardon, L.R., Fulker, D.W. & Jöreskog, K. (1991). A LISREL model with constrained parameters for twin and adoptive families. *Behavior Genetics* **21**:327-350.
- Carey, G. (1986). A general multivariate approach to linear modeling in human genetics. *American Journal Human Genetics* **39**:775-786.
- Eaves, L.J., Last, K., Young, P.A., Martin, N.G. (1978). Model fitting approaches to the analysis of human behaviour. *Heredity* **41**:249-320.
- Eaves, L.J., Neale, M.C., Maes, H. (1996). Multivariate multipoint linkage analysis of Quantitative Trait Loci. *Behavior Genetics* **26**: 519-525.
- Everitt, B.S. (1984). *An introduction to latent variables models*. London, New York: Chapman and Hall.

- Fraser, C. (1988). *COSAN User's Guide* Unpublished documentation, Centre for Behavioural Studies in Education, University of New England, Armidale NSW Australia 2351.
- Fulker, D.W. (1982). Extensions of the classical twin method. In *Human genetics, part A: The unfolding genome* (pp. 395-406). New York: Alan R. Liss.
- Fulker, D.W. (1988). Genetic and cultural transmission in human behavior. In: B.S. Weir, E.J. Eisen, M. Goodman & G. Namkoong (eds.) *Proceedings of the Second International Conference on Quantitative Genetics* Massachusetts: Sinauer Associates Inc.
- Genz, A. (1992) Statistics applications of subregion adaptive multiple numerical integration. In: T.O. Espelid, A. Genz, (eds.) *Numerical Integration* (pp. 267-280). Dordrecht, NL.: Kluwer Academic Publishers.
- Heath, A.C., Neale, M.C., Hewitt, J.K., Eaves, L.J., & Fulker, D.W. (1989a). Testing structural equation models for twin data using LISREL. *Behavior Genetics*, **19**:9-36.
- Heath, A.C., Eaves, L.J., & Martin, N.G. (1989b). The genetic structure of personality III. Multivariate genetic item analysis of the EPQ scales. *Personality and Individual Differences* **10**:877-888.
- Hopper, J.L. & Mathews, J.D. (1982). Extensions to multivariate normal models for pedigree analysis. *Ann. Hum. Genet.* **46**:373-383.
- Horn, J. & McArdle, J.J. (1992) A practical and theoretical guide to measurement invariance in aging research. *Experimental Aging Res* **18**:117-144.
- Johnson, N.I. & Kotz, S. (1970). *Distributions in Statistics: Continuous Univariate Distributions 1*. Boston: Houghton Mifflin.
- Jöreskog, K.G. (1967). Some contributions to maximum likelihood factor analysis. *Psychometrika* **32**:443-482.
- Jöreskog, K.G. & Goldberger, A.S. (1972). Factor analysis by weighted least squares. *Journal of the American Statistical Association* **10**:631-639.
- Jöreskog, K.G. (1973). A general method for estimating a linear structural equation system. In: A.S. Goldberger & O.D. Duncan (Eds.) *Structural equation models in the social sciences*. New York: Seminar Press.
- Jöreskog, K.G. & Sörbom, D. (1986). *PRELIS: A Preprocessor for LISREL*. Scientific Software: Mooresville, Indiana.
- Jöreskog, K.G. & Sörbom, D. (1989). *LISREL 7: A Guide to the Program and Applications* 2nd Edition. Chicago, Illinois: SPSS Inc.
- Jöreskog, K.G. & Sörbom, D. (1993). *New features in PRELIS 2* Chicago: Scientific Software International, Inc.

- Kaplan, D. (1990). Evaluating and modifying covariance structure models: A review and recommendation. *Multivariate Behavioral Research* **25**:137-155.
- Karlin, S., Cameron, E.C. & Chakraborty, R. (1983). Path analysis in genetic epidemiology: A critique. *American Journal of Human Genetics* **35**:695-732.
- Kendall, M., Stuart, A. (1977). *The advanced theory of statistics*. New York: Macmillan.
- Lange, K., Westlake, J., Spence, M. (1976). Extensions to pedigree analysis: III. Variance components by the scoring method. *Annals of human genetics* **39**:485-491.
- Little, R.J.A. & Rubin, D.B. (1978) *Statistical Analysis with Missing Data*. New York: Wiley and Son.
- Loehlin, J.C. (1987). *Latent variable models*. Baltimore: Lawrence Erlbaum Associates.
- Marsh, H.W., Balla, J., Hau, K.T. (1997). An evaluation of incremental fit indices: A clarification of mathematical and empirical properties. In G.A. Marcoulides & R.E. Schumacker (Eds.), *Advanced Structural Equation Modeling: Issues and Techniques*. Erlbaum.
- Maxwell, A.E. (1977). *Multivariate Analysis in Behavioral Research*. New York: John Wiley.
- McArdle, J.J. (1980). Causal modeling applied to psychonomic systems simulation. *Behavior Research Methods and Instrumentation* **12**:193-209.
- McArdle, J.J. & Boker, S.M. (1990). *RAMpath: Path diagram software*. Denver: Data Transforms Inc.
- McDonald, R.P. (1989). An index of goodness-of-fit based on noncentrality. *Journal of Classification* **6**: 97-103.
- McDonald, R.P., and Marsh, H.W. (1990). Choosing a multivariate model: Noncentrality and goodness of fit. *Psychological Bulletin* **107**: 247-255.
- Meeker, W.Q., Escobar, L.A. (1995). Teaching about approximate confidence regions based on maximum likelihood estimation. *Am. Stat.* **49**: 48-53.
- Mulaik, S., James, L.R., Van Alstine, J., Bennett, N., Lind, S., Stillwell, C.D. (1989). An evaluation of goodness of fit indices for structural equation models. *Psychological Bulletin* **105**: 430-445.
- NAG (1990). *The NAG Fortran Library Manual, Mark 14*. Oxford: Numerical Algorithms Group.
- Neale, M.C. & Cardon, L.R. (1992). *Methodology for genetic studies of twins and families* Dordrecht, NL: Kluwer Academic Publishers.

- Neale, M.C. & Fulker, D.W. (1984). A bivariate path analysis of fear data on twins and their parents. *Acta Geneticae Medicae et Gemellologiae* **33**:273-286.
- Neale, M.C., Heath, A.C., Hewitt, J.K., Eaves, L.J., & Fulker, D.W. (1989). Fitting genetic models with LISREL: Hypothesis testing. *Behavior Genetics* **19**:37-50.
- Neale, M.C. & Martin, N.G. (1989). The effects of age, sex and genotype on self-report drunkenness following a challenge dose of alcohol *Behavior Genetics* **19**:63-78.
- Neale, M.C. & McArdle, J.J. (1990). The analysis of assortative mating: A LISREL model. *Behavior Genetics* **20**:287-298.
- Neale, M.C., Walters, E.E., Eaves, L.J., Maes, H.H., Kendler, K.S., (1994). Multivariate genetic analysis of twin-family data on fears: An MX Model. *Behavior Genetics* **24**: 119-139.
- Neale, M.C., Miller, M.B. (1997). The use of likelihood-based confidence intervals in genetic models. *Behavior Genetics* **27**: 113-120.
- Pearl, J. (1994). Causal diagrams for empirical research. Technical Report (R-218-B). *Biometrika* **82**: 669-709.
- Phillips, K., Fulker, D.W., Carey, G. & Nagoshi, C.T. (1988). Direct marital assortment for cognitive and personality variables. *Behavior Genetics* **18**:347-356.
- Rigdon, E. E. and Ferguson, C. E. (1991). The performance of the polychoric correlation coefficient and selected fitting functions in confirmatory factor analysis with ordinal data. *Journal of Marketing Research* **28**:491-497.
- Rindskopf, D.A. (1984). The use of phantom and imaginary latent variables to parameterize constraints in linear structural models. *Psychometrika* **49**:37-47.
- Schervish, M.J. (1984). Multivariate normal probability with error bounded. *Appl. Stat.* **33**:81-94
- Searle, S.R. (1982).. *Matrix Algebra Useful for Statistics*. New York: John Wiley.
- Steiger, J. (1994). *SEPATH User's Guide*. Tulsa OK: Statsoft, Inc.
- Steiger, J.H., Lind, J.C. (1980). Statistically-based tests for the number of common factors. Paper presented at the annual Spring Meeting of the Psychometric Society in Iowa City.
- Tanaka, J.S. (1993). Multifaceted conceptions of fit in structural equation models. In K.A. Bollen & J.S. Long (Eds.), *Testing Structural Equation Models* (pp.10-39). Sage Publications.
- Tucker, L.R. and Lewis, C. (1973). A reliability coefficient for maximum likelihood factor analysis. *Psychometrika* **38**: 1-10.

Van Eerdewegh, P. (1982). *Statistical Selection in Multivariate Systems with Applications in Quantitative Genetics*. Unpublished doctoral dissertation, Washington University, St. Louis, Mo.

Vogler, G.P. (1985). Multivariate path analysis of familial resemblance. *Genet. Epid.* **2**:35-54.

Williams, L.J. and Holahan, P.J. (1994). Parsimony-based fit indices for multiple-indicator models: do they work? *Structural Equation Modeling* **1**: 161-189.

Index

- #define command 40
- absolute value 61
- ACE model 19, 106
- addition 58
- address 17
- adjusting degrees of freedom 89
- age regression 116
- Akaike's Information Criterion 14, 87
- algebra
 - begin 41
- ascending order 67
- ascertainment
 - correction 86, 140
 - non-random 86
- ASCII 37
- assortative mating 104, 119
- asymptotic
 - covariance matrix 43
 - variance matrix 43
 - weight matrix 43
 - weight matrix inverse 44
- asymptotic weighted least squares . . 43, 81
- binary files 97
 - get 99
 - save 99
- bivariate normal distribution 85, 140
- bound command 76
- boundary constraints 76
- building models 51
- calculation groups 42, 49, 103
- changing optimization parameters 95
- chi-squared 87
 - confidence intervals 14, 64, 90
- Cholesky decomposition 112
- clipboard 24
- code
 - blue 96
 - green 96
 - red 96
- cold restart 93
- column covariances 64
- column means 64
- comments 37
- comparative fit indices 25
- computed matrices 53
- confidence intervals 17, 18, 90
 - fit 26
 - fit statistics 93
- constraint groups 31, 42, 49
- constraints
 - boundary 76
 - degrees of freedom 49
 - example script 119
 - function of parameters 49, 76
 - inequality 76
 - non-linear 119
 - range 76
- contingency tables 80
 - analysis 85
 - example script 122
 - input 46
- continuous raw data 82
- correlation matrix 43, 80
 - analysis 120
 - degrees of freedom 89
 - input 43
 - standardize 63
- covariance matrix 43, 80
 - asymptotic 43, 80
 - calculation from data 161
 - expected 53
 - input 43
 - modeling 68, 80
 - observed 53
 - positive definite 82
 - standardize 63
- covariances
 - estimating 131
- covariances command 68
- cultural/genetic transmission 124
- data groups 42
- data line 42
- datamap 12
- debug output 25
- decimal places 88
- default
 - fit function 79
 - matrix input 43
- define'd variables 40
- definition variables 33, 46, 133
- degrees of freedom 33, 87, 89
- descending order 67
- determinant 61
- diagonal matrix 52
- diagonal matrix to vector 62
- diagonally weighted least squares . . 43, 82
- diagrams
 - automap 20, 22

- datamap 19, 20
- DZ twins 20
- MZ twins 19
- unmap 22
- DOS text 37
- dot product 57
- download 143
- draw command 102
- drop command 99
- element by element division 58
- email 17
- end command 79
- equate command 74
- equating
 - all matrices across groups 53
 - matrices across groups 52
 - matrices to computed matrices .. 53
- error 147
- error messages 147
 - incorrect 154
- estimating means and covariances 131
- example scripts
 - ACE model 106
 - age regression 116
 - analysis of correlation matrices . 120
 - assortative mating 104, 119
 - calculation groups 103
 - Cholesky decomposition 112
 - constraint groups 119
 - contingency tables 122
 - correction for ascertainment ... 140
 - cultural/genetic transmission ... 124
 - definition variables 133
 - estimating means and covariances
 - 131
 - general matrix algebra 103
 - genetically informative data ... 106
 - heterogeneity 135
 - matrix inversion 103
 - NModel 135
 - PACE model 114
 - power calculation 108
 - predicted covariance matrix 104
 - principal component 119
 - RAM specification 110
 - raw data 131
 - selection formula 105
 - sex limitation 116
 - twins and parents 124
 - user-defined fit functions 140
 - variable pedigree sizes 132
- expected
 - covariance matrix ... 15, 53, 77, 88
 - mean vector 53
 - proportions 53
- exponent 62
- exporting
 - diagrams 27
 - matrices 24
- extract part 67
- feedback loop 6, 169
- file keyword 43
- filename conventions 28, 144
- files 28
 - binary 99
 - individual likelihood statistics .. 101
 - matrices 101
 - RAMpath 102
 - transferring 30
- fit functions 79
 - AWLS 81
 - contingency tables maximum likelihood 85
 - covariances 80
 - covariances and means 81
 - default 79
 - DWLS 82
 - GLS 81
 - LS 80
 - LSML 82
 - maximum likelihood 80
 - ML 80
 - raw data maximum likelihood ... 82
 - raw ordinal data maximum likelihood
 - 83
 - standard 80
 - user-defined 86
- fit indices 25, 94
- fit statistics
 - confidence intervals 93
- fitting submodels 97
- fix command 73
- format
 - free 43
- free command 73
- free format 43
- free keyword 53
- frequency command 70
- full matrix 52
- full matrix input 43
- function value 53
- generalized least squares 81
- genetically informative data 106
- get command 99
- goodness-of-fit 87
- grant support 15

- graphical interface 11, 143
 - extending models 19
 - fitting models 12
 - output options 23
 - revising models 16
 - running jobs 28
- graphics output 102, 110
- group-type line 42
- groups
 - calculation 38, 49
 - constraint 38, 49
 - data 38
 - structure 38
 - types 38
- heterogeneity 135
- higher moments 47
- horizontal adhesion 59
- host options panel
 - backend memory 31
 - local host 29
 - remote host 29
 - remotely 29
- html 145
- HTML output 25
- hypertext 145
- identification 92, 95
- identification codes 77
 - absolute value 45
- identity matrix 52
- identity/zero matrix 52
- IFAIL codes 13, 96
- imaginary eigenvalues 64
- imaginary eigenvectors 64
- incomplete data 82
- individual likelihood statistics 25, 101
- inequality constraints 76
- input variables
 - labels 47
 - select 48
- intervals 66
- inverse 56
 - asymptotic weight matrix 43
- iterations parameter 96
- jiggling parameter starting values 93
- job compare 24
- job option panel 24
- job options
 - confidence intervals on fit 26
 - debug output 25
 - HTML and text appearance 25
 - HTML output 25
 - individual likelihood files 25
 - optimization options 26
 - power calculation 26
 - restart 26
 - standardize 26
 - statistical output 25
 - text output 25
- job structure 38
- keywords
 - definition 37
 - numeric input 37
 - parameter 37
- kronecker product 57
- labels
 - input variables 47
 - matrix rows and columns 76
- least squares 80
 - asymptotic weighted 81
 - diagonally weighted 82
 - generalized 81
- least squares maximum likelihood 82
- likelihood ratio statistics
 - automatically computing 94
- lower matrix to vector 63
- lower triangular matrix 52
- matrices
 - argument of functions 59
 - available functions 59
 - available operators 55
 - begin 41, 51
 - building models with 51
 - computed 53
 - concept 155
 - constrained equal 53
 - declaration 41
 - default fixed status 53
 - equating 52, 53
 - examples of forms 54
 - introduction to 155
 - modifiable elements of 71
 - negative definiteness 165
 - number of elements 43
 - positive definiteness 81, 82, 112, 165
 - putting numbers into 71
 - putting parameters into 73
 - reading from files 43
 - singular 165
 - specifying 75
 - writing to files 97
- matrix algebra 1, 156
 - calculation of covariance matrix 161
 - determinant 164
 - equations 160

- example script 103
- inverse 165
- multistatement 41
- transformations 163
- matrix algebra binary operations
 - addition 156
 - multiplication 157
 - subtraction 156
- matrix algebra unary operations
 - inverse 165
 - transposition 156
- matrix command 71
- matrix formulae 55, 68
- matrix functions
 - absolute value 61
 - all intervals 66
 - ascending order 67
 - column covariances 64
 - column means 64
 - cosine 61
 - descending order 67
 - determinant 61
 - diagonal to vector 62
 - eigenvalues, imaginary 64
 - eigenvalues, real 64
 - exponent 62
 - extract part 67
 - lower triangle of matrix to vector
 - 63
 - matrix to vector 62, 63
 - maximum 61
 - minimum 61
 - moments of truncated multinormal
 - 65
 - multivariate normal density 64
 - multivariate normal integration 64
 - natural logarithm 62
 - probability of chi squared 64
 - product 61
 - sin 61
 - sort columns 67
 - sort rows 67
 - square root 62
 - standardize 63
 - sum 61
 - tan 61
 - trace 61
 - trigonometric functions 61
 - vector to diagonal 62
- matrix input
 - full 43
 - lower triangle 43
 - symmetric 43
- matrix operations
 - addition 58
 - direct product 57
 - dot product 57
 - element by element division 58
 - horizontal adhesion 59
 - inverse 56
 - kronecker product 57
 - multiplication 56
 - order of evaluations 55
 - power 56
 - quadratic 57
 - subtraction 58
 - transpose 56
 - vertical adhesion 59
- matrix to vector 62
- matrix types 52
 - computed 52, 53
 - diagonal 52
 - elements 52
 - full 52
 - identity 52
 - identity|zero 52
 - lower triangular 52
 - null 52
 - standardized 52
 - subdiagonal 52
 - symmetric 52
 - types available 52
 - unit 52
 - zero|identity 52
- matrix types constrained
 - expected matrix 53
 - expected mean vector 53
 - expected proportions 53
 - function value 53
 - observed matrix 53
- maximum 61
- maximum likelihood 14
 - contingency tables 85
 - covariances 80
 - penalty function 81
 - raw data 82
 - raw ordinal data 83
- mean vector
 - expected 53
- means
 - estimating 131
 - input 47
 - modeling 22, 68
- means command 68
- minimum 61
- missing command 46

- missing data 82
- models
 - covariances 68
 - frequency 70
 - identification 92
 - means 68
 - threshold 69
 - weight 70
- moderator variables 33
- moments of truncated multinormal 65
- MSDOS 143
- multiple fit option 97
- multiple groups 19
- multiplication 56
- multistatement matrix algebra 41
- multivariate approach 9
- multivariate normal density 64
 - all intervals 66
- multivariate normal integration 64
- Mx
 - installing 143
 - obtaining 143
 - using 143
- MX command 100
- NAG parameters 96
- NAGDUMP.OUT file 96
- natural logarithm 62
- Netscape 145
- NModel 70, 135
- no output option 88
- non-linear constraints 31, 119
- non-numeric characters 147
- non-random ascertainment 86
- number of
 - columns 88
 - decimal places 88
 - groups 42
 - input variables 42
 - observations 42
- observed
 - covariance matrix 53, 83, 88
- operating systems 143
 - MSDOS 143
 - UNIX 145
 - VAX VMS 145
 - Windows 143
- optimization options 95
- optimization parameters 13
 - feasibility 96
 - function precision 97
 - infinite step size 97
 - iterations 96
 - linesearch tolerance 97
- NAG output 96
- optimality tolerance 97
- options
 - fit functions 79
 - optimization 87, 95
 - statistical output 87
- options command 79
- ordinal files 44, 83
 - analysis 83
- ordinal raw data 83
- outliers 48
- output command 79
- PACE model 110, 114, 122
- parameter estimates
 - confidence intervals 90
- parameters
 - calculation 42
 - constraint 42
 - dropping 99
 - equating 74
 - fixing 73
 - freeing 73
 - group-line 42
 - number of groups 42
 - number of input variables 42
 - number of observations 42
 - optimization 95
 - options line 79
- path inspector 17
- paths
 - attributes 17
 - causal 16
 - covariance 16
 - curving lines 17
 - equating 18
 - fixing parameters 18
 - moving 19
 - relabel 20
- pattern command 73
- Pearson-Aitken selection formula 105
- pedigree structure 77
- penalty function
 - maximum likelihood 81
- positive definiteness 81, 165
- power 56
- power calculation
 - degrees of freedom 89
 - example script 108
 - fit 26
 - probability level 89
 - statistical 89
- principal components 119
- printing 26

- preference 27
- preview 27
- print quality 27
- probability 64
- proband ascertainment 86
- product 61
- project manager 12, 14
 - add grid 27
 - arrow 16, 19, 22
 - circle 18
 - copy 20, 24, 27
 - covariance 16, 17, 20
 - manager 14
 - new drawing 12, 20
 - new file 12
 - open 28
 - paste 20
 - pointer 17
 - preview 26, 27
 - printer 26
 - resizing 15
 - save file 12, 16
 - selection 19
 - snap to grid 27
 - statistics 15
 - triangle 22
 - undo 17
 - value 15
 - variance 13, 16
 - view 15
 - zoom in 23
 - zoom out 20, 23
 - zoom undo 23
- proportions
 - expected 53
- quadratic product 57
- RAM model 2
- RAM specification 110, 125
- RAMPATH 2, 102, 110
- randomizing starting values 92
- raw data 80
 - analysis 82
 - example script 131
- raw maximum likelihood 82
- reading
 - binary files 99
- reading data 43
 - asymptotic weight matrix 43
 - contingency tables 46
 - correlation matrix 43
 - covariance matrix 43
 - ordinal files 44
 - rectangular files 44
 - variable length data 44
- reading matrices
 - diagonal of correlation matrix ... 43
 - from files 43
 - full 43
 - non-symmetric 43
 - symmetric 43
- real eigenvalues 64
- real eigenvectors 64
- reciprocal causation 169
- reciprocal interaction 114
- rectangular files
 - analysis 82
 - input 44
- residual matrix 15
 - weighted 88
- residuals 88
- results box panel 14
- results panel 13
- RMSEA 14, 87
- running jobs 28
 - performance 29
 - remote host 30
 - scripts 28
 - Unix workstations 29
- sampling
 - non-random 86
- SAS 45
- save command 99
- saving computer time 98
- saving matrices 97, 100
- script style 1
- select
 - input variables 48
 - variables 77
- select if 48
- SEM 1
- setting optimization parameters 96
- sex limitation 116
- simultaneous equations 160
- sort columns 67
- sort rows 67
- specification command 75
- SPSS 45
- square root 62
- standard errors 92
- standard output 87
 - AIC 87
 - chi-squared 87
 - degrees of freedom 87
 - RMSEA 87
- standardize 26, 63
- standardized matrix 52

- start command 72
- starting values 72
 - jiggling 93
 - randomizing 92
- statistical output options 87
 - adjusting degrees of freedom ... 89
 - appearance 88
 - check identification of model ... 95
 - confidence intervals 90
 - confidence intervals on fit statistics
..... 93
 - fit indices 94
 - jiggling parameter starting values
..... 93
 - likelihood ratio statistics 94
 - power calculations 89
 - randomizing starting values 92
 - residuals 88
 - standard errors 92
 - submodels 94
 - suppressing output 88
- statistical power 89
- structural equation model 2
- subdiagonal matrix 52
- submodels
 - appending matrices to files 101
 - dropping parameters 99
 - formatting matrices 101
 - multiple fit 97
 - reading binary files 99
 - writing binary files 99
 - writing individual likelihood statistics
to files 101
 - writing matrices to files 100
- subtraction 58
- sum 61
- suppressing output 88
- symmetric matrix 52
- syntax conventions 37
- system requirements 143
- text appearance 25
- text output 25
- threshold command 69
- title 42
- title line 42
- trace 61
- transpose 56
- trigonometric functions 61
- try hard 92
- twin data 106
- twins and parents 124
- types
 - group 38
 - matrix 52
 - unit matrix 52
- UNIX 145
- user-defined fit function 86, 140
- value command 72
- variable
 - defined 40
 - definition 46
- variable length data 80
 - analysis 82
 - input 44
- variable length files 77
 - example script 132
- variable pedigree sizes 132
- VAX VMS 145
- vector to diagonal matrix 62
- vertical adhesion 59
- VL files 44
- warning 147
- weight command 70
- weight matrix
 - asymptotic 43
- width of output 88
- Windows 143
- writing
 - binary files 97, 99
 - matrices to files 97, 100
 - statistics to file 101
- zero matrix 52
- zero|identity matrix 52