

# Introduction to multivariate QTL

- Theory
- Practical: Genetic analysis of Blood Pressure data (4 observations across a 20 year period)
- QTL analysis of multivariate data
- Practical: QTL analysis BP data

Dorret Boomsma, Meike Bartels,  
Danielle Posthuma & Sarah Medland

# Multivariate models

- Principal component analysis (Cholesky)
- Exploratory factor analysis (Spss)
- Confirmatory factor analysis (Lisrel)
- Path analysis (S Wright)
- Structural equation models

These techniques are used to analyze multivariate data that have been collected in *non-experimental* designs and often involve *latent constructs* that are not directly observed.

These latent constructs underlie the observed variables and account for correlations between variables.

The covariance between  $x_1$  and  $x_4$  is:

$$\text{cov}(x_1, x_4) = \lambda_1 \lambda_4 \psi = \text{cov}(\lambda_1 f + e_1, \lambda_4 f + e_4)$$

where  $\psi$  is the variance of  $f$  and  $e_1$  and  $e_4$  are uncorrelated

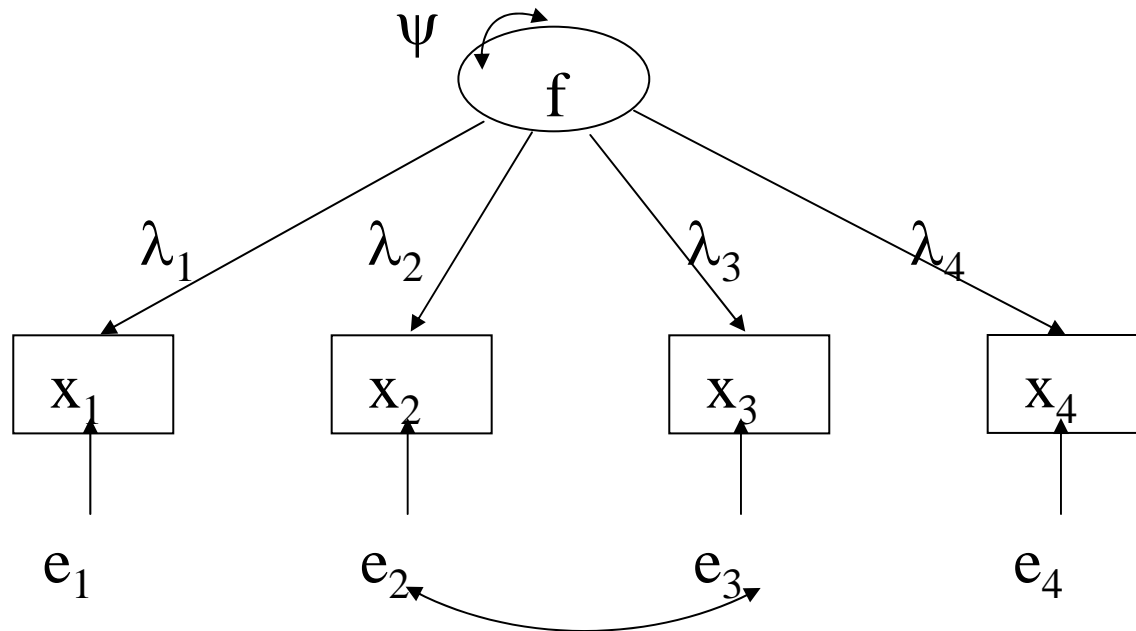

Sometimes  $x = \Lambda f + e$  is referred to as the measurement model.

The part of the model that specifies relations among latent factors is the covariance structure model, or the structural equation model

# Symbols used in path analysis

 square box: observed variable ( $x$ )

 circle: latent (unobserved) variable ( $f$ )

unenclosed variable: disturbance term (error) in equation ( $\zeta$ ) or measurement ( $e$ )

 straight arrow: causal relation ( $\lambda$ )

 curved two-headed arrow: association ( $r$ )

 two straight arrows: feedback loop

# Tracing rules of path analysis

The associations between variables in a path diagram is derived by tracing all connecting paths between variables:

- 1 trace backward along an arrow, then forward
  - never forward and then back;
  - never through adjacent arrow heads
- 2 pass through each variable only once
- 3 trace through at most one two-way arrow

The expected correlation/covariance between two variables is the product of all coefficients in a chain and summing over all possible chains (assuming no feedback loops)

# Genetic Structural Equation Models

Confirmatory factor model:  $x = \Lambda f + e$ , where

$x$  = observed variables

$f$  = (unobserved) factor scores

$e$  = unique factor / error

$\Lambda$  = matrix of factor loadings

"Univariate" genetic factor model

$$P_j = hG_j + e E_j + c C_j, \quad j = 1, \dots, n \text{ (subjects)}$$

where  $P$  = measured phenotype

$G$  = unmeasured genotypic value

$C$  = unmeasured environment common to family members

$E$  = unmeasured unique environment

$\Lambda$  =  $h, c, e$  (factor loadings/path coefficients)

# Univariate ACE Model for a Twin Pair

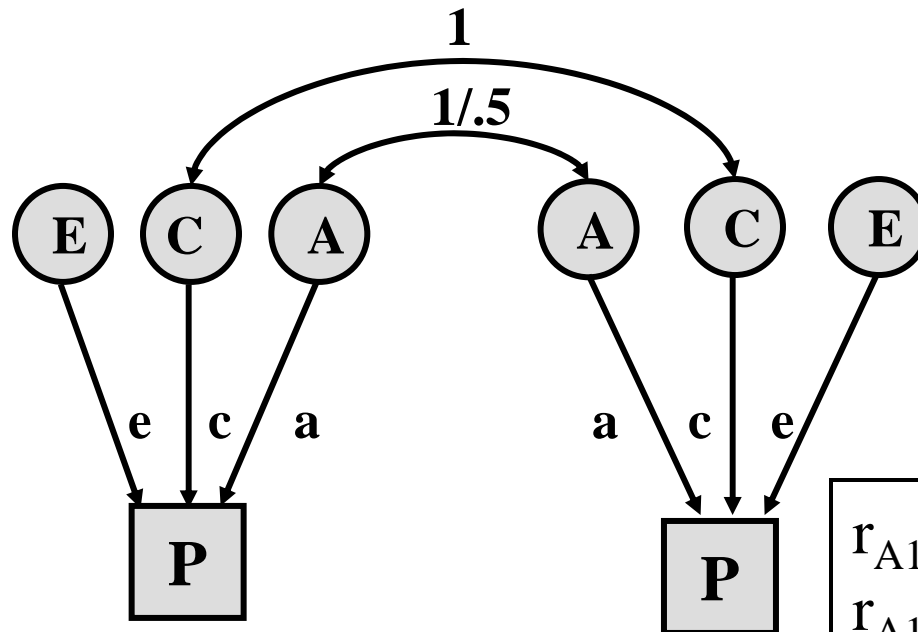

$$\Sigma_{MZ} = \begin{bmatrix} a^2 + c^2 + e^2 & a^2 + c^2 \\ a^2 + c^2 & a^2 + c^2 + e^2 \end{bmatrix}$$

$$\Sigma_{DZ} = \begin{bmatrix} a^2 + c^2 + e^2 & .5a^2 + c^2 \\ .5a^2 + c^2 & a^2 + c^2 + e^2 \end{bmatrix}$$

$$r_{A1A2} = 1 \text{ for MZ}$$

$$r_{A1A2} = 0.5 \text{ for DZ}$$

Covariance (P1, P2)  
 $= a r_{A1A2} a + c^2$

$$r_{MZ} = a^2 + c^2$$

$$r_{DZ} = 0.5 a^2 + c^2$$

$$2(r_{MZ} - r_{DZ}) = a^2$$

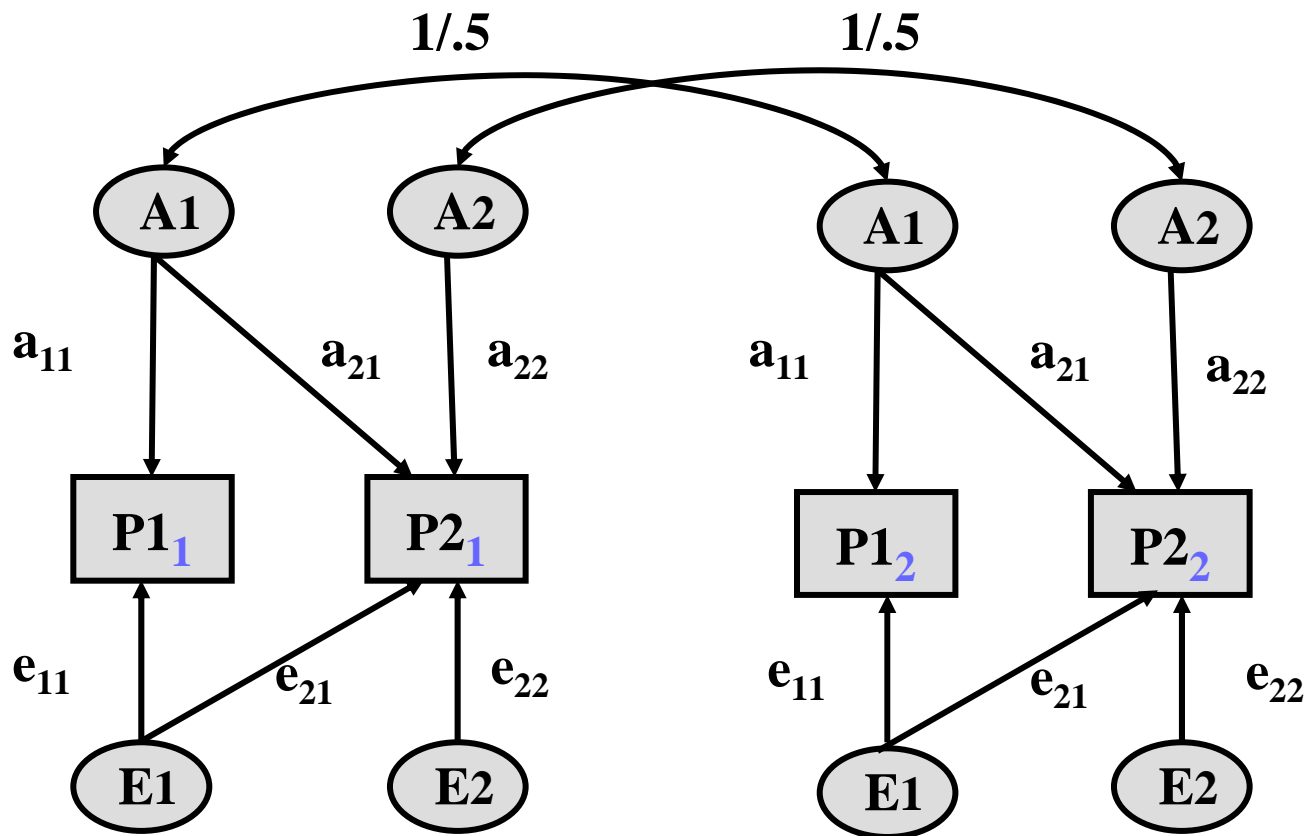

### Bivariate twin model:

The first (latent) additive genetic factor influences P1 and P2;  
 The second additive genetic factor influences P2 only.  
 A1 in twin 1 and A1 twin 2 are correlated; A2 in twin 1 and A2  
 in twin 2 are correlated (A1 and A2 are uncorrelated)



## Identification in Genetics

Identification of a genetic model is obtained by using data from genetically related individuals, such as twins, or parents and offspring, and by knowledge about the constraints for certain parameters in the model, whose values are based on Mendelian inheritance.

Quantitative genetic theory offers a strong foundation for the application of these models in genetic epidemiology because unambiguous causal relationships can be specified. For example, genes 'cause' a variable like blood pressure and parental genes determine those of children and not vice versa

# Bivariate Phenotypes

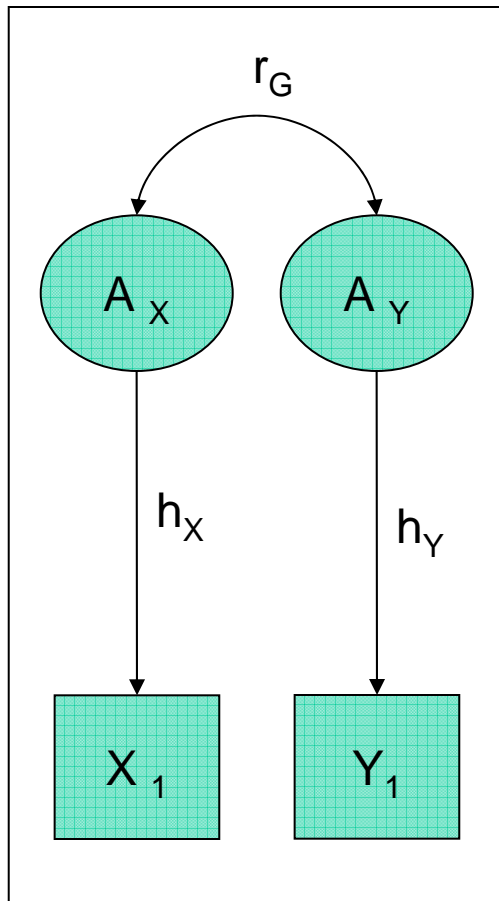

Correlation

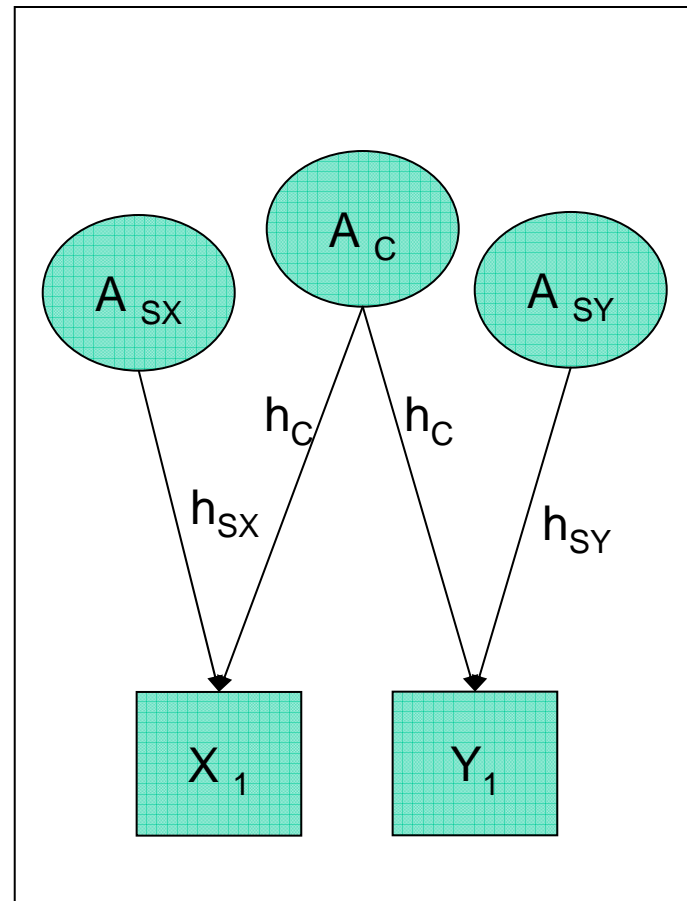

Common factor

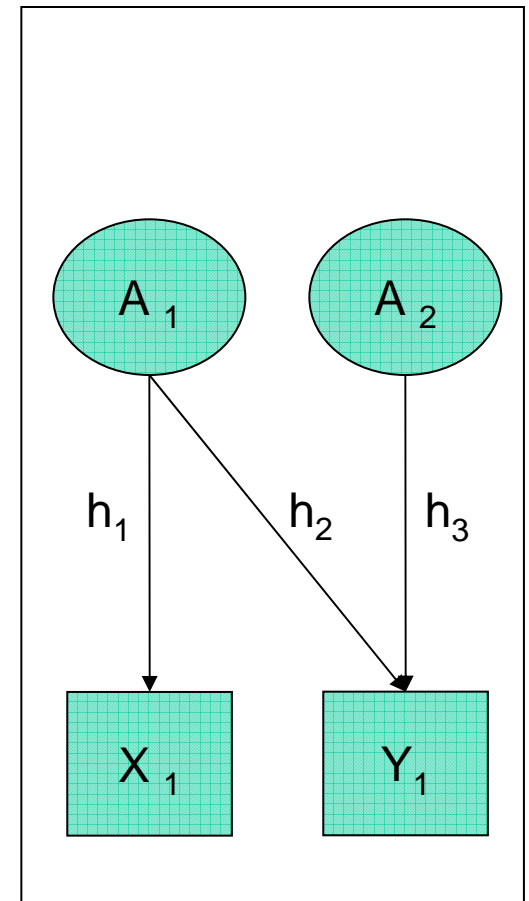

Cholesky  
decomposition

# Correlated factors

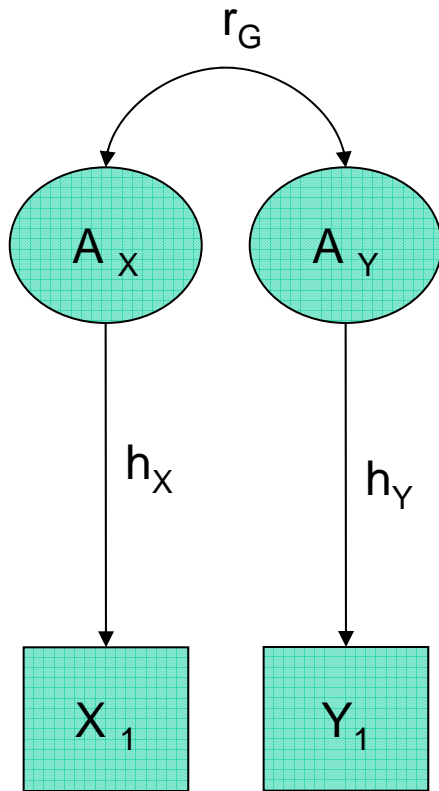

- Genetic correlation  $r_G$
- Component of phenotypic covariance

$$r_{XY} = h_X r_G h_Y + c_X r_C c_Y + e_X r_E e_Y$$

# Common factor model

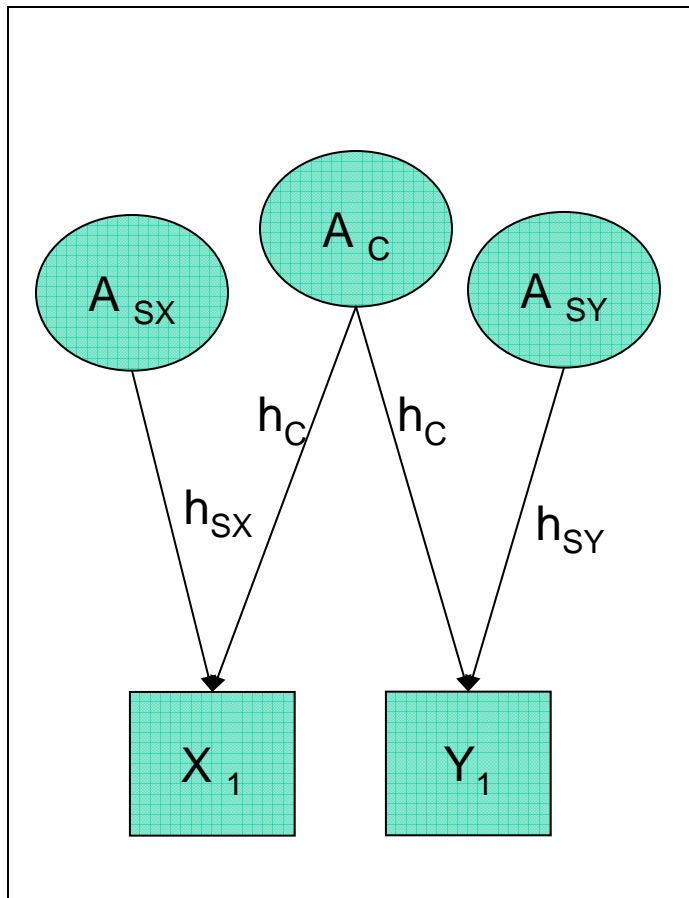

A constraint on the factor loadings is needed to make this model identified

# Cholesky decomposition

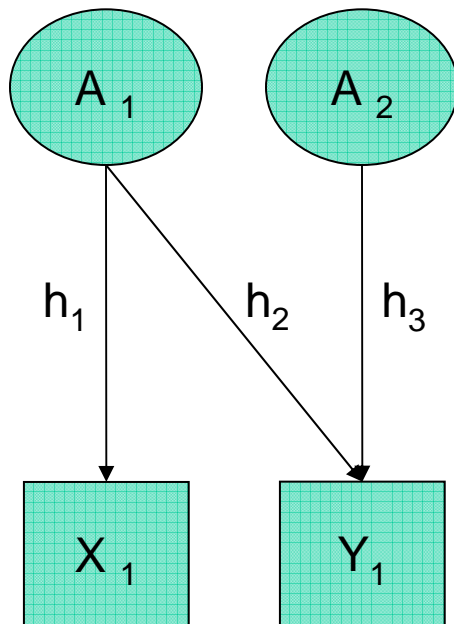

- If  $h_3 = 0$ : no genetic influences specific to  $Y$
- If  $h_2 = 0$ : no genetic covariance
- The genetic correlation between  $X$  and  $Y = \text{covariance} / \text{SD}(X) * \text{SD}(Y)$

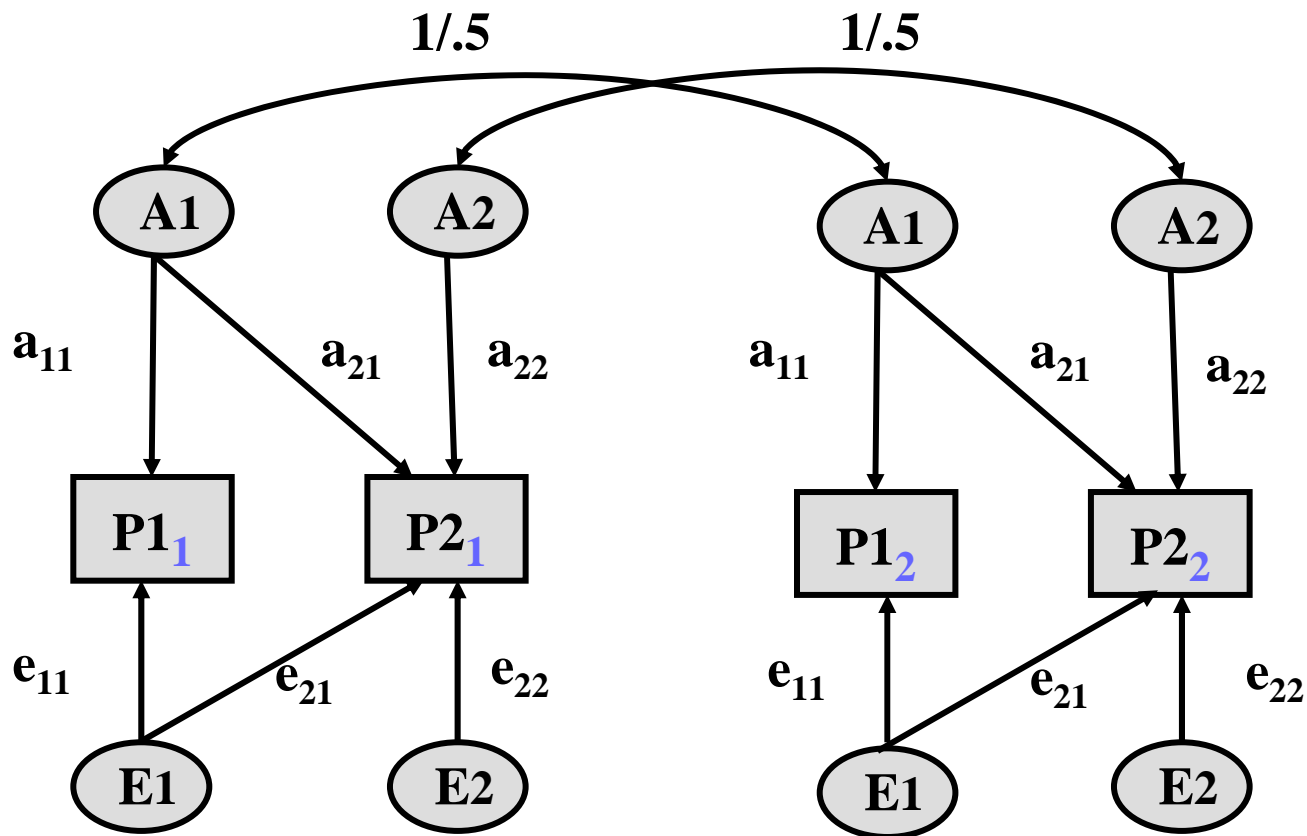

### Bivariate twin model:

The first (latent) additive genetic factor influences P1 and P2;

The second additive genetic factor influences P2 only.

A1 in twin 1 and A1 twin 2 are correlated; A2 in twin 1 and A2 in twin 2 are correlated (A1 and A2 are uncorrelated)

# Implied covariance structure

- See handout

# Four variables: blood pressure

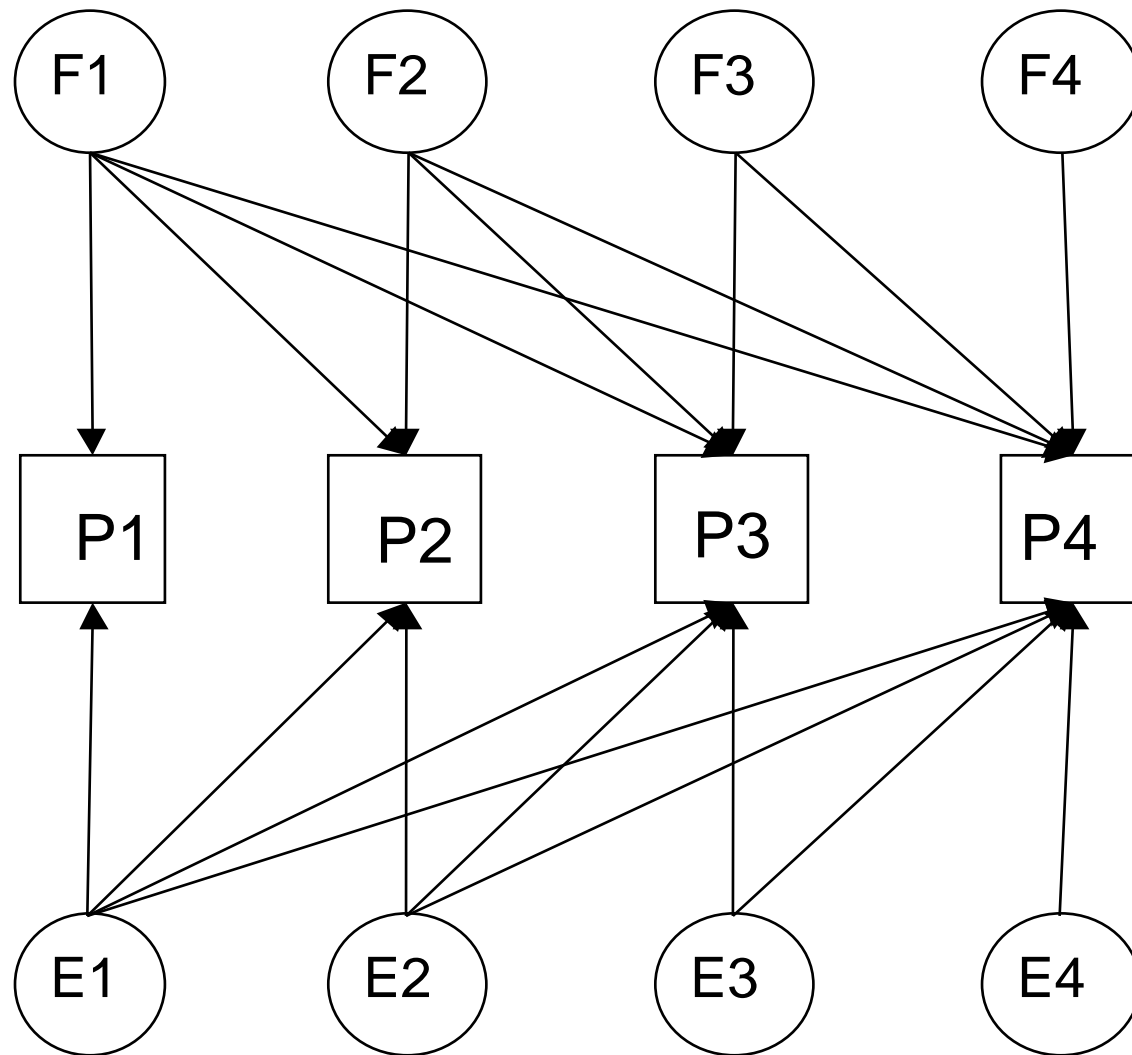

F: Is there  
familial (G or C)  
transmission?

E: Is there  
transmission of  
non-familial  
influences?



# Genome-wide scans for blood pressure in Dutch twins and sibs

## Phenotypes:

|                                    |                 |
|------------------------------------|-----------------|
| Dorret Boomsma                     | (study 1; 1985) |
| Harold Snieder                     | (study 2; 1990) |
| Danielle Posthuma                  | (study 3; 1998) |
| Mireille van den Berg /Nina Kupper | (study 4; 2002) |

Eco de Geus

Jouke Jan Hottenga

Vrije Universiteit, Amsterdam

## Genotypes

Eline Slagboom

Marian Beekman

Bas Heijmans

Jim Weber

Molecular Epidemiology, Leiden

Marshfield, USA

# Design and N of individuals

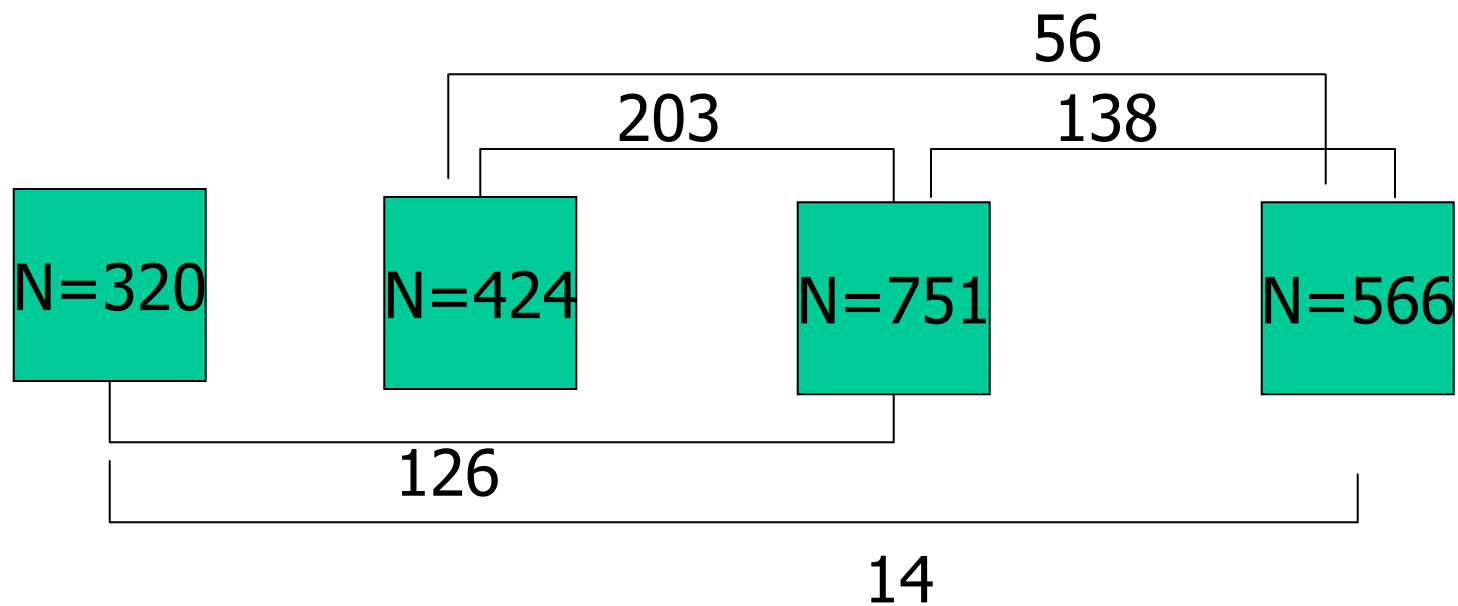

N of Ss who participated in 3 studies: 53,  
in 2 studies: 378 and in 1 study: 1146  
(only offspring; 1 Ss from triplets and families with size > 6 removed)  
BP levels corrected for medication use

## Study 1 (Dorret): 320 adolescent twins (& parents)

### Blood pressure\*

- Systolic
- Diastolic
- MAP
- Heart rate
- Inter-beat interval
- Variability
- RSA
- Pre-ejection period
- Height / Weight
- Birth size
- Non-cholest. Sterols
- Lipids
- CRP
- Fibrinogen
- HRG

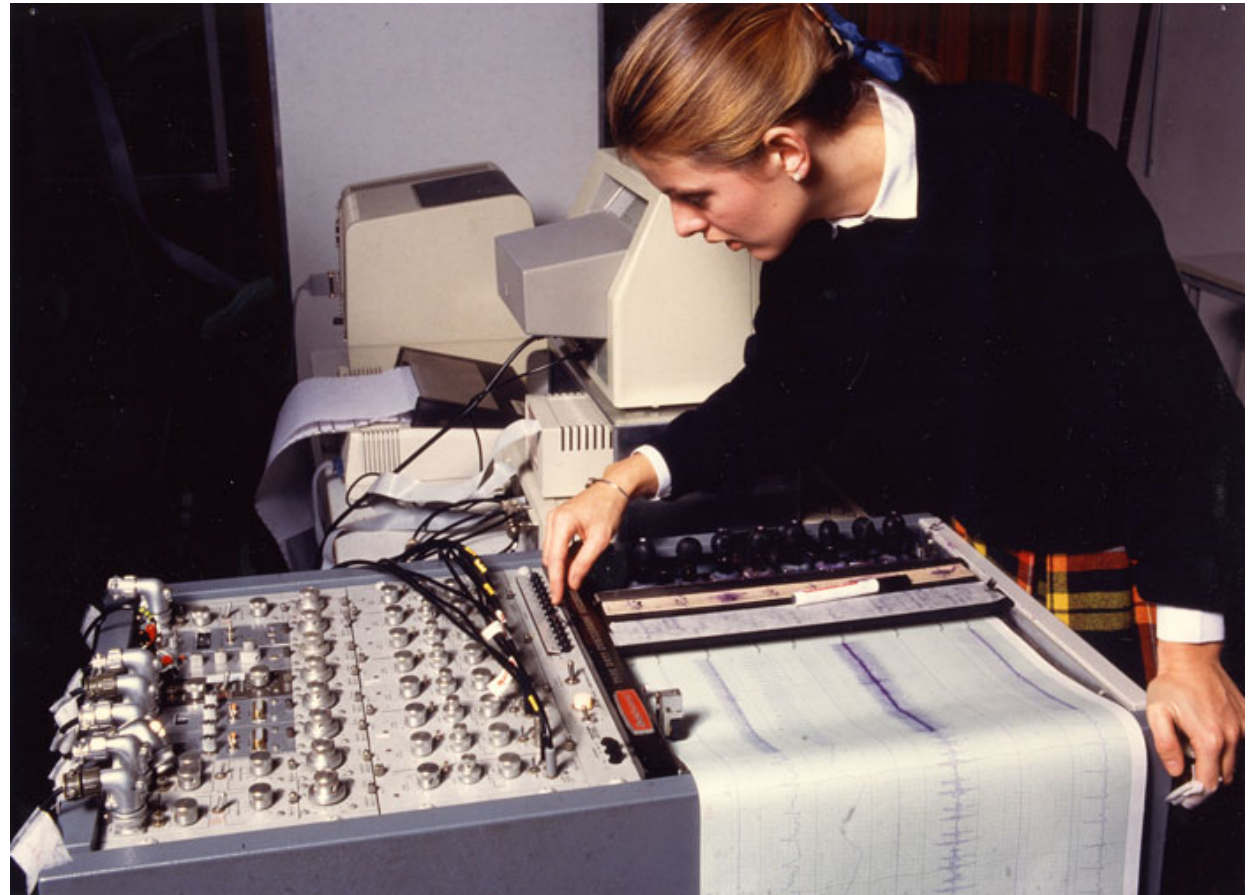

\* Assessed in rest and during stress; resting BP averaged over 6 measures

Boomsma, Snieder, de Geus, van Doornen. Heritability of blood pressure increases during mental stress. Twin Res. 1998

## Study 2 (Harold): 424 adult twins

Same as study 1 plus

- Waist & hip circumference,
- Skin folds
- %fat
- PAI,
- tPA,
- v. Willebrand
- Glucose
- Insuline
- Hematocrit



BP assessed in rest and during stress; resting BP averaged over 3 measures

Snieder, Doornen van, Boomsma, Developmental genetic trends in blood pressure levels and blood pressure reactivity to stress, in: Behavior Genetic Approaches in Behavioral Medicine, Plenum Press, New York, 1995

## Study 3 (Danielle): 751 adult twins and sibs

- Cognition
- Memory
- Executive function
- EEG/ ERP
- MRI
- blood pressure

BP assessed in rest;  
averaged over 3  
measures

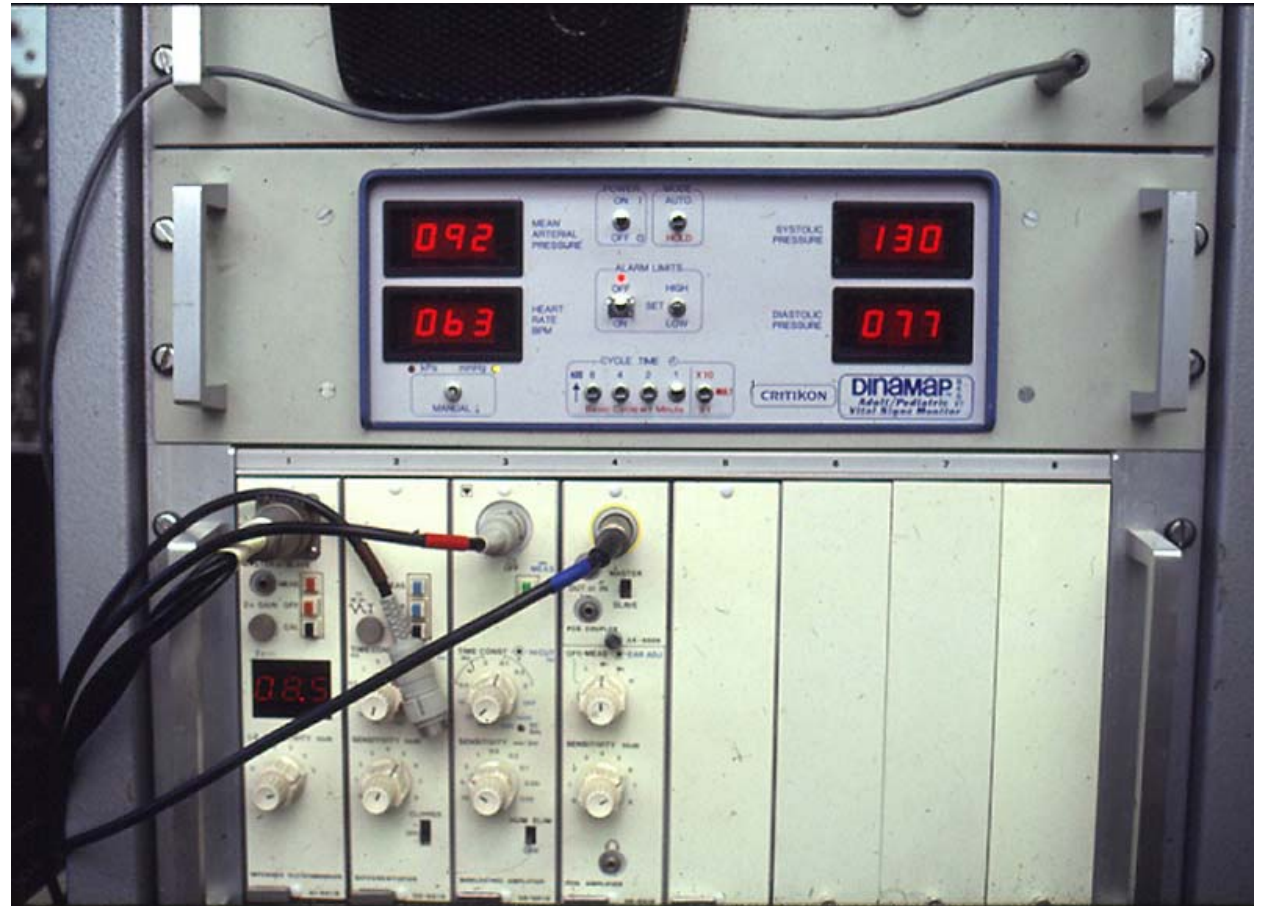

Evans et al. The genetics of coronary heart disease: the contribution of twin studies.  
Twin Res. 2003

## Study 4 (Nina): 566 adult twins and sibs

### Ambulatory measures

- ECG
- ICG
- RR
- cortisol
- blood pressure

Average of at least 3 ambulatory BP measures while sitting (during evening)



Kupper, Willemsen, Riese, Posthuma, Boomsma, de Geus. Heritability of daytime ambulatory blood pressure in an extended twin design. Hypertension 2005

| Sex   | Variable | Dorret<br>Study 1 | Harold<br>Study 2 | Danielle<br>Study 3 | Nina<br>Study 4 |
|-------|----------|-------------------|-------------------|---------------------|-----------------|
| MZ M  | N        | 70                | 92                | 117                 | 57              |
|       | age      | 16.6 (1.8)        | 42.9 (5.6)        | 36.8 (12.3)         | 34.0 (13.1)     |
|       | SBP      | 119.8 (8.2)       | 129.1 (11.9)      | 129.7 (14.4)        | 129.7 (11.1)    |
|       | DBP      | 65.6 (6.4)        | 80.5 (9.6)        | 77.6 (12.6)         | 77.5 (9.6)      |
| F     | N        | 70                | 98                | 147                 | 108             |
|       | age      | 16.0 (2.2)        | 45.4 (7.4)        | 39.0 (13.1)         | 29.0 (10.5)     |
|       | SBP      | 115.0 (5.7)       | 120.7 (12.0)      | 122.5 (14.4)        | 124.0 (10.8)    |
|       | DBP      | 67.6 (4.7)        | 73.5 (10.0)       | 74.8 (10.0)         | 77.1 (9.2)      |
| DZ M  | N        | 91                | 114               | 125                 | 80              |
|       | age      | 16.9 (1.8)        | 44.6 (7.1)        | 36.2 (13.1)         | 29.3 (8.8)      |
|       | SBP      | 119.8 (9.3)       | 127.6 (11.7)      | 129.6 (12.4)        | 131.1 (10.7)    |
|       | DBP      | 65.6 (7.4)        | 78.2 (8.9)        | 77.6 (11.8)         | 77.6 (8.9)      |
| F     | N        | 89                | 120               | 175                 | 137             |
|       | age      | 17.2 (1.9)        | 44.1 (6.3)        | 37.0 (12.7)         | 30.9 (11.3)     |
|       | SBP      | 115.3 (7.3)       | 124.5 (16.2)      | 124.6 (16.2)        | 125.4 (12.9)    |
|       | DBP      | 67.9 (5.6)        | 75.7 (11.8)       | 76.1 (11.0)         | 78.0 (10.9)     |
| Sib M | N        | -                 | -                 | 88                  | 74              |
|       | age      | -                 | -                 | 37.3 (14.2)         | 35.2 (13.1)     |
|       | SBP      | -                 | -                 | 128.3 (13.0)        | 130.4 (9.7)     |
|       | DBP      | -                 | -                 | 78.3 (11.2)         | 79.2 (8.4)      |
| F     | N        | -                 | -                 | 99                  | 110             |
|       | age      | -                 | -                 | 37.3 (12.8)         | 36.7 (11.9)     |
|       | SBP      | -                 | -                 | 124.3 (16.4)        | 122.6 (12.2)    |
|       | DBP      | -                 | -                 | 76.4 (10.2)         | 77.0 (9.7)      |

Data corrected for medication use (by adding means effect of van anti-hypertensiva)

# Stability (correlations SBP / DBP) between measures in 1983, 1990, 1998 and 2003

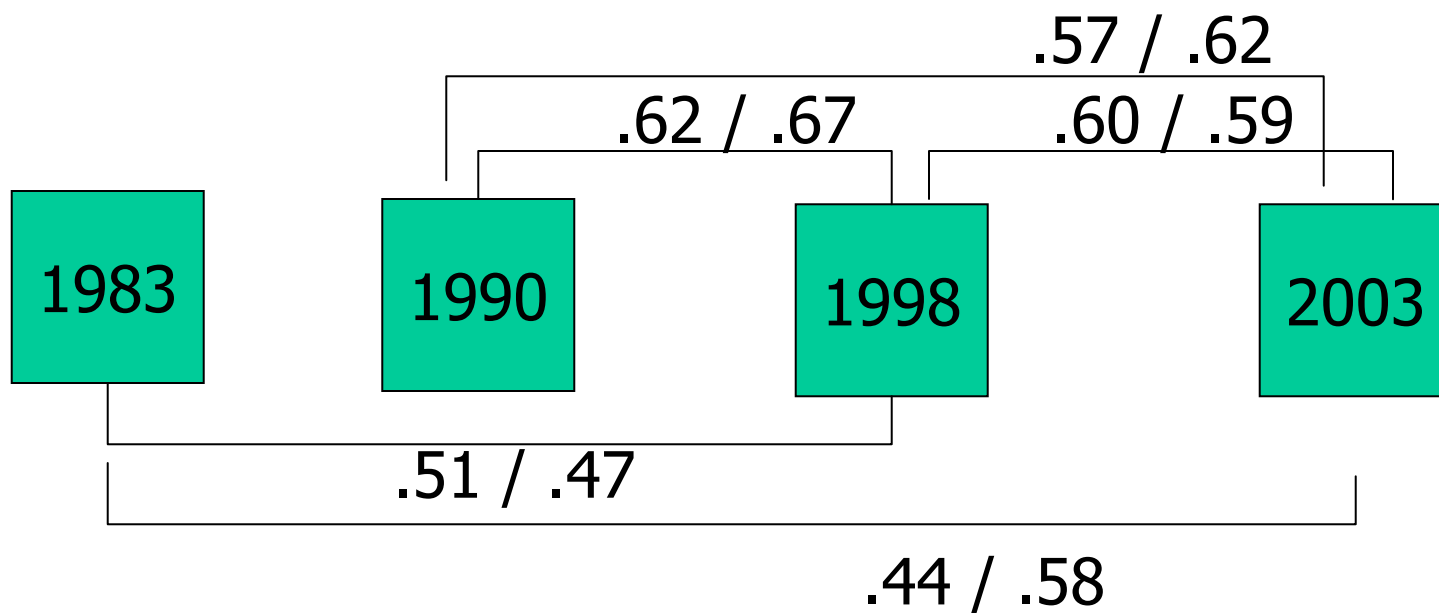

Does heritability change over time?

Is heritability different for ambulatory measures?

What is the cause of stability over time?



# Assignment

- ACE Cholesky decomposition on SBP (and / or DBP) on all data (4 time points)
- Test for significance of A and C
- What are the familial correlations across time (i.e. among A and / or C factors)
- Can the lower matrix for A, C, E be reduced to a simpler structure?

# Four blood pressure measurements

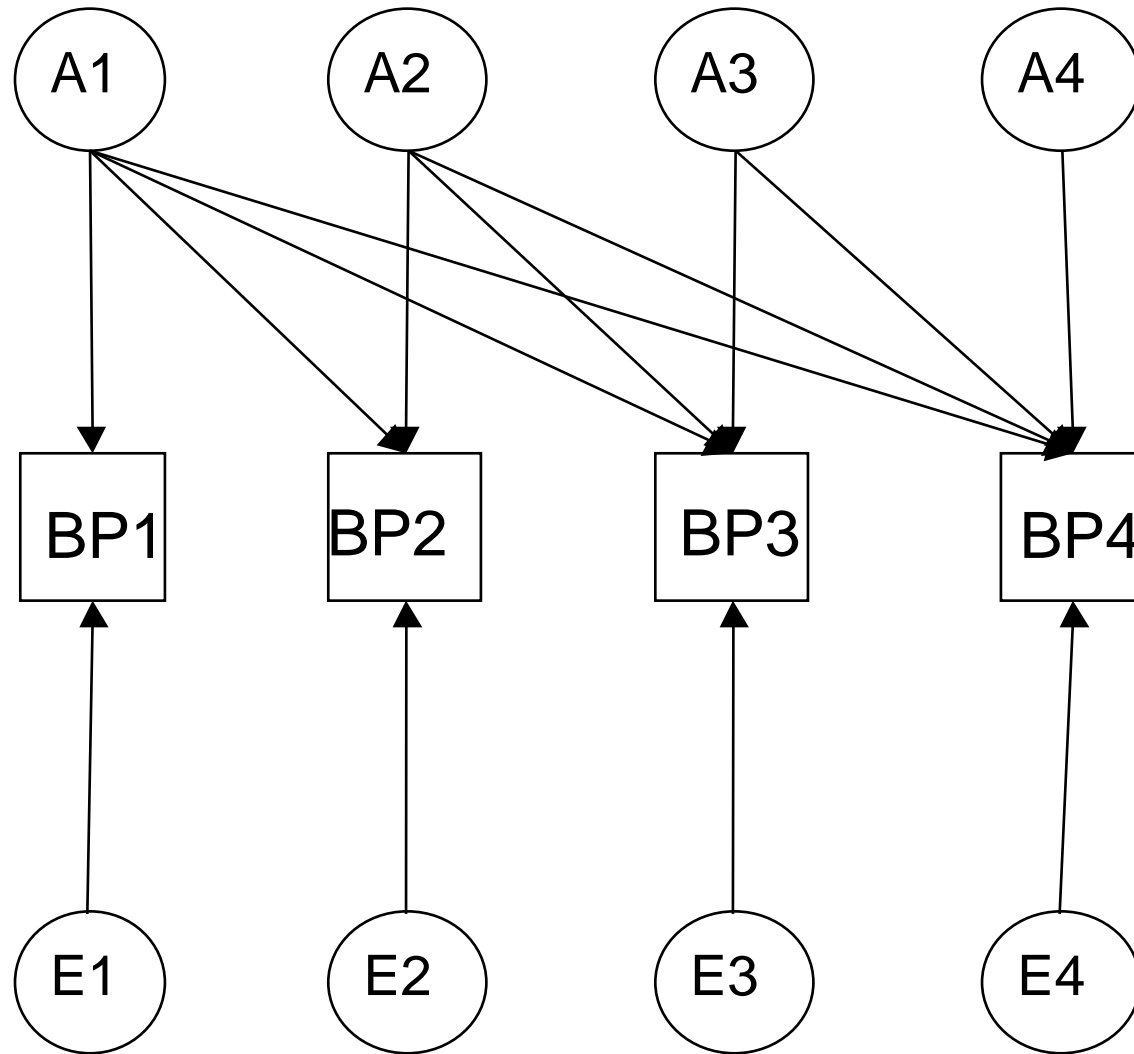

Can A be reduced to 1 factor?

E: Is there transmission over time (is E a diagonal matrix?)

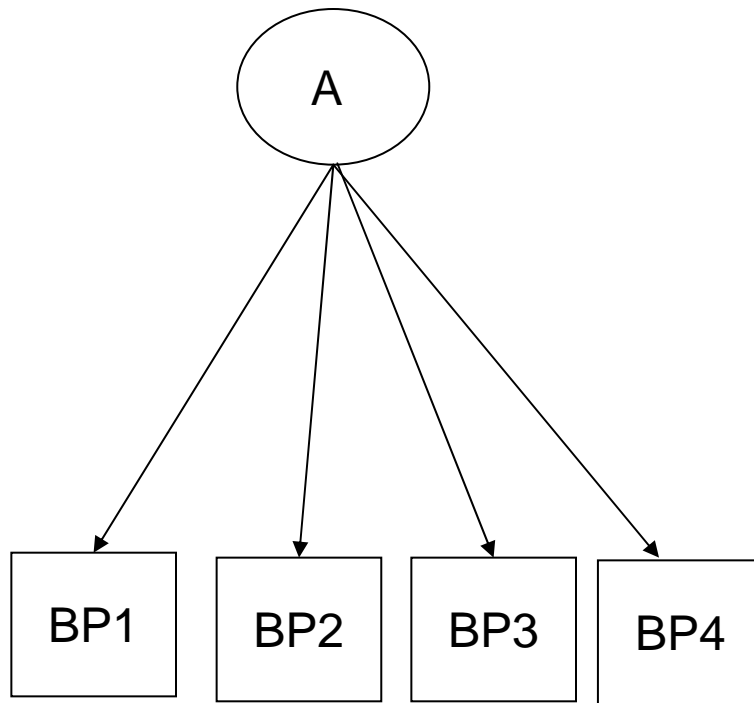

Can the model for A  
(additive genetic  
influences) be  
reduced to 1 factor?

```
#DEFINE NVAR 4
#DEFINE NDEF 2 ! NUMBER OF DEFINITION VARIABLES
#NGROUPS 3 ! NUMBER OF GROUPS
```

G1: CALCULATION GROUP

DATA CALCULATION

BEGIN MATRICES

```
X LOWER NVAR NVAR FREE ! ADDTIVE GENETIC
Y LOWER NVAR NVAR FREE ! COMMON ENVIRONMENT
Z LOWER NVAR NVAR FREE ! UNIQUE ENVIRONMENT
H FULL 1 1 FIX ! HALF-MATRIX (contains 0.5)
```

```
G FULL 1 8 FREE ! GENERAL MEANS SAMPLES
R FULL NDEF 1 FREE ! DORRET REGRESSION COEFFICIENTS COVARIATES
S FULL NDEF 1 FREE ! HAROLD REGRESSION COEFFICIENTS COVARIATES
T FULL NDEF 1 FREE ! DANIELLE REGRESSION COEFFICIENTS
U FULL NDEF 1 FREE ! NINA REGRESSION COEFFICIENTS C
END MATRICES
```

G2: MZM

DATA NINPUT\_VARS=45

MISSING=-99.0000

RECTANGULAR FILE = C11P50.PRN

LABELS

ID1 ID2 PAIRTP TWZYG

DOSEX1 DOAGE1 DOMDBP1 DOMSBP1 DOMED1

HASEX1 HAAGE1 HAMDBP1 HAMSBP1 HAMED1

DASEX1 DAAGE1 DAMDBP1 DAMSBP1 DAMED1

NISEX1 NIAGE1 NIMDBP1 NIMSBP1 NIMED1

DOSEX2 DOAGE2 DOMDBP2 DOMSBP2 DOMED2

HASEX2 HAAGE2 HAMDBP2 HAMSBP2 HAMED2

DASEX2 DAAGE2 DAMDBP2 DAMSBP2 DAMED2

NISEX2 NIAGE2 NIMDBP2 NIMSBP2 NIMED2 PIHAT !data for twin1 and twin2

SELECT IF TWZYG < 4; !MZ Selected

SELECT IF TWZYG ^= 2;

SELECT

DOSEX1 DOAGE1 HASEX1 HAAGE1 DASEX1 DAAGE1 NISEX1 NIAGE1

DOMSBP1 HAMSBP1 DAMSBP1 NIMSBP1

DOSEX2 DOAGE2 HASEX2 HAAGE2 DASEX2 DAAGE2 NISEX2 NIAGE2

DOMSBP2 HAMSBP2 DAMSBP2 NIMSBP2;

DEFINITION

DOSEX1 DOAGE1 DOSEX2 DOAGE2 HASEX1 HAAGE1 HASEX2 HAAGE2

DASEX1 DAAGE1 DASEX2 DAAGE2 NISEX1 NIAGE1 NISEX2 NIAGE2;

# Data and scripts

- F:\meike\BP2005\phenotypic
- ACEBP Elower.mx: 4 variate script for genetic analysis (Cholesky decomposition)
- Input file = C11P50.prn
  - ACE Cholesky decomposition on SBP (and / or DBP) on all data (4 time points)
  - Test for significance of A and C
  - What are the familial correlations across time (i.e. among A and / or C factors)
  - Can the lower matrix for A, C, E be reduced to a simpler structure?

# Results total sample (systolic BP)

-2log-likelihood of data

- ACE Cholesky, 42 parameters, 16261.760
- E diagonal, 36 parameters, 16268.885
- A factor, no C, E Cholesky,  
26 parameters, 16263.931
- A factor, no C, E diagonal,  
20 parameters, 16270.298

# Full cholesky model

## MATRIX K

This is a computed FULL matrix of order 4 by 4  
[=\STND(A)]

|   | 1      | 2      | 3      | 4      |
|---|--------|--------|--------|--------|
| 1 | 1.0000 | 0.8813 | 0.9653 | 0.9975 |
| 2 | 0.8813 | 1.0000 | 0.8873 | 0.8890 |
| 3 | 0.9653 | 0.8873 | 1.0000 | 0.9814 |
| 4 | 0.9975 | 0.8890 | 0.9814 | 1.0000 |

Heritability = 51, 41, 57, 43%

## MATRIX L

This is a computed FULL matrix of order 4 by 4  
[=\STND(C)]

|   | 1       | 2       | 3       | 4       |
|---|---------|---------|---------|---------|
| 1 | 1.0000  | 1.0000  | -0.9999 | 1.0000  |
| 2 | 1.0000  | 1.0000  | -0.9999 | 1.0000  |
| 3 | -0.9999 | -0.9999 | 1.0000  | -1.0000 |
| 4 | 1.0000  | 1.0000  | -1.0000 | 1.0000  |

Common E = 06, 00, 00, 01%

## MATRIX M

This is a computed FULL matrix of order 4 by 4  
[=\STND(E)]

|   | 1       | 2       | 3      | 4       |
|---|---------|---------|--------|---------|
| 1 | 1.0000  | -0.0732 | 0.1795 | 0.3984  |
| 2 | -0.0732 | 1.0000  | 0.1898 | -0.0273 |
| 3 | 0.1795  | 0.1898  | 1.0000 | 0.1498  |
| 4 | 0.3984  | -0.0273 | 0.1498 | 1.0000  |

Unique E = 42, 58, 43, 55%



# Multivariate QTL effects

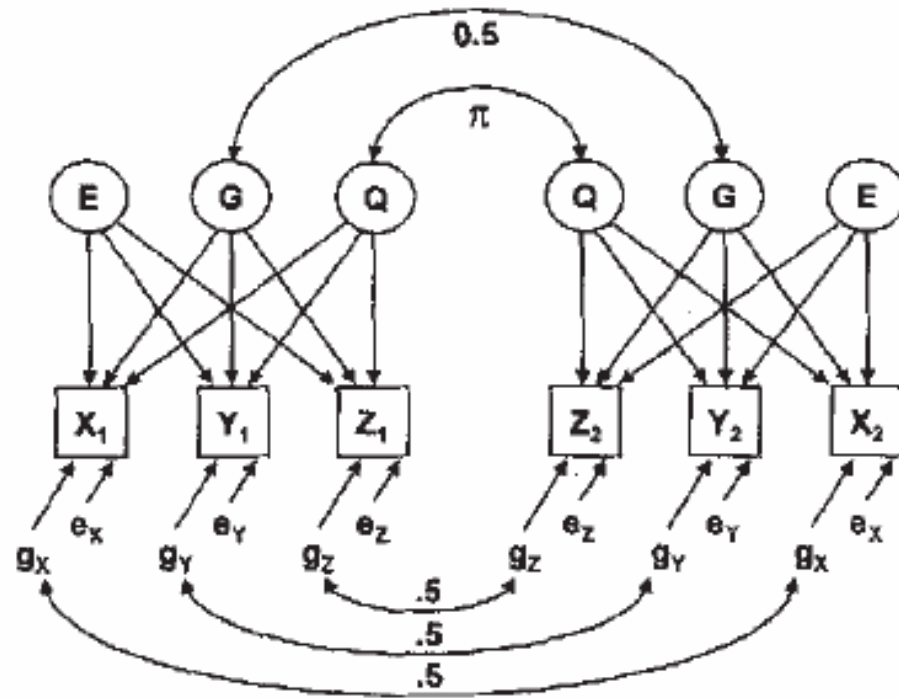

**Fig.1** Multivariate path model showing quantitative trait locus (Q), genetic background (G) and environmental factors (E) common to three phenotypes (X, Y and Z) plus genetic (g) and environmental (e) factors unique to each trait. Traits are measured in two siblings, or DZ twins.

Martin N, Boomsma DI, Machin G, A twin-pronged attack on complex traits, *Nature Genet*, 17, 387-391, 1997

See: [www.tweelingenregister.org](http://www.tweelingenregister.org)

# Multivariate phenotypes & multiple QTL effects

For the QTL effect, multiple orthogonal factors can be defined (triangular matrix).

By permitting the maximum number of factors that can be resolved by the data, it is theoretically possible to detect effects of multiple QTLs that are linked to a marker (Vogler et al. Genet Epid 1997)

For example:

on chromosome 19: apolipoprotein E, C1, C4 and C2

# Multivariate phenotypes & multiple QTL effects

## Multivariate QTL analysis

- Insight into etiology of genetic associations (pathways)
- Practical considerations (e.g. longitudinal data)
- Increase in statistical power:

Boomsma DI, Using multivariate genetic modeling to detect pleiotropic quantitative trait loci, *Behav Genet*, 26, 161-166, 1996

Boomsma DI, Dolan CV, A comparison of power to detect a QTL in sib-pair data using multivariate phenotypes, mean phenotypes, and factor-scores, *Behav Genet*, 28, 329-340, 1998

Evans DM. The power of multivariate quantitative-trait loci linkage analysis is influenced by the correlation between variables. *Am J Hum Genet*. 2002, 1599-602

Marlow et al. Use of multivariate linkage analysis for dissection of a complex cognitive trait. *Am J Hum Genet*. 2003, 561-70

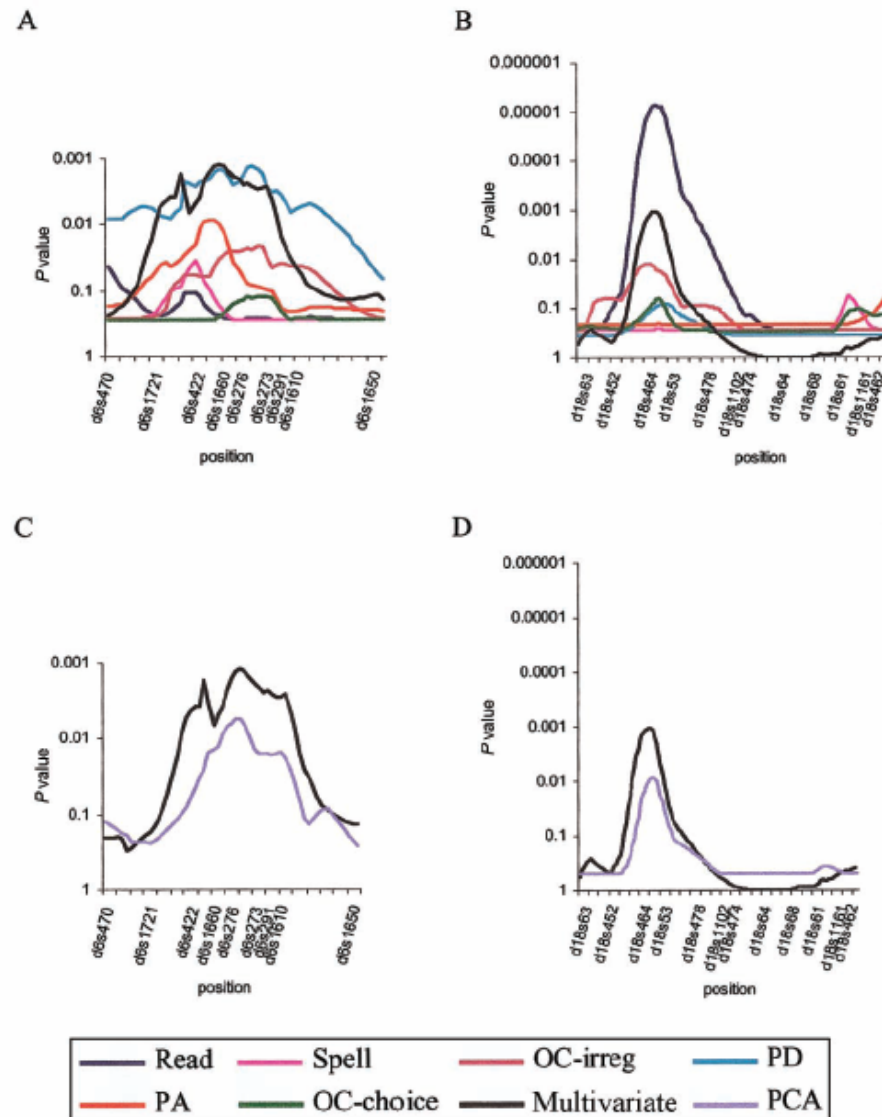

**Figure 1** Multivariate and univariate linkage analysis of the six reading-related measures—on a 54-cM region of chromosome 6p (A) and a 137-cM region spanning the whole of chromosome 18 (B)—and comparison of multivariate linkage and use of the first factor from a PCA approach as the phenotypic measure for linkage analysis, on chromosomes 6p (C) and 18 (D). A subset of the markers is shown on the graphs. The significance of the linkage results are reported in all cases as *P* values. For univariate measures, the *P* values are empirically derived as described elsewhere (Fisher et al. 2002a); for multivariate and PCA results, the *P* values are asymptotic, as described in the text.

## Genome-wide scan in DZ twins and sibs

- 688 short tandem repeats (autosomal) combined from two scans of 370 and 400 markers for ~1100 individuals (including 296 parents; ~100 Ss participated in both scans)
- Average spacing ~8.8 cM (9.7 Marshfield, 7.8 Leiden)
- Average genotyping success rate ~85%

# Genome-wide scan in DZ twins and sibs

- Marker-data: calculate proportion alleles shared identical-by-decent ( $\hat{\pi}$ )

- $\hat{\pi} = \pi_1/2 + \pi_2$

- IBD estimates obtained from Merlin
- Decode genetic map

Quality controls:

- MZ twins tested
- Check relationships (GRR)
- Mendel checks (Pedstats / Unknown)
- Unlikely double recombinants (Merlin)

# Genome-Wide Scan for Blood Pressure Suggests Linkage to Chromosome 11, and Replication of Loci on 16, 17, and 22

Marlies de Lange, Tim D. Spector, Toby Andrew

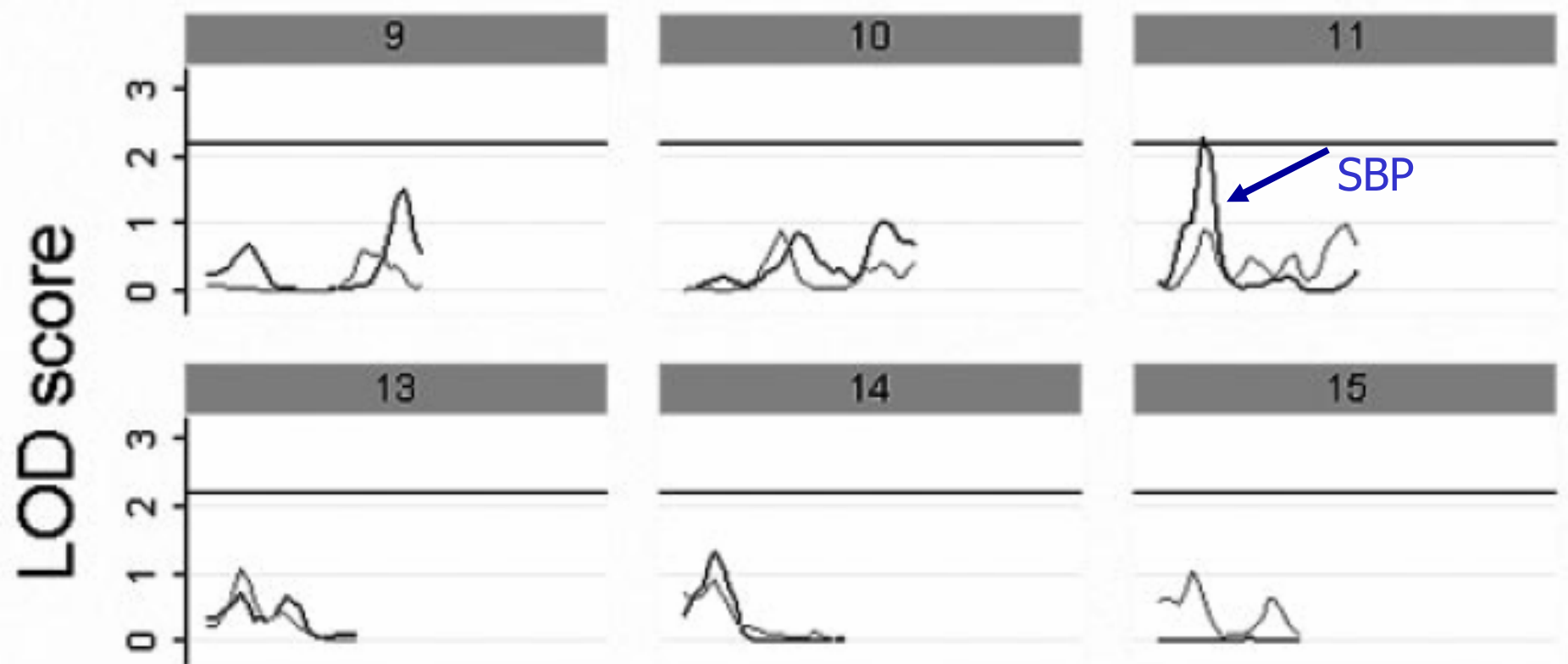

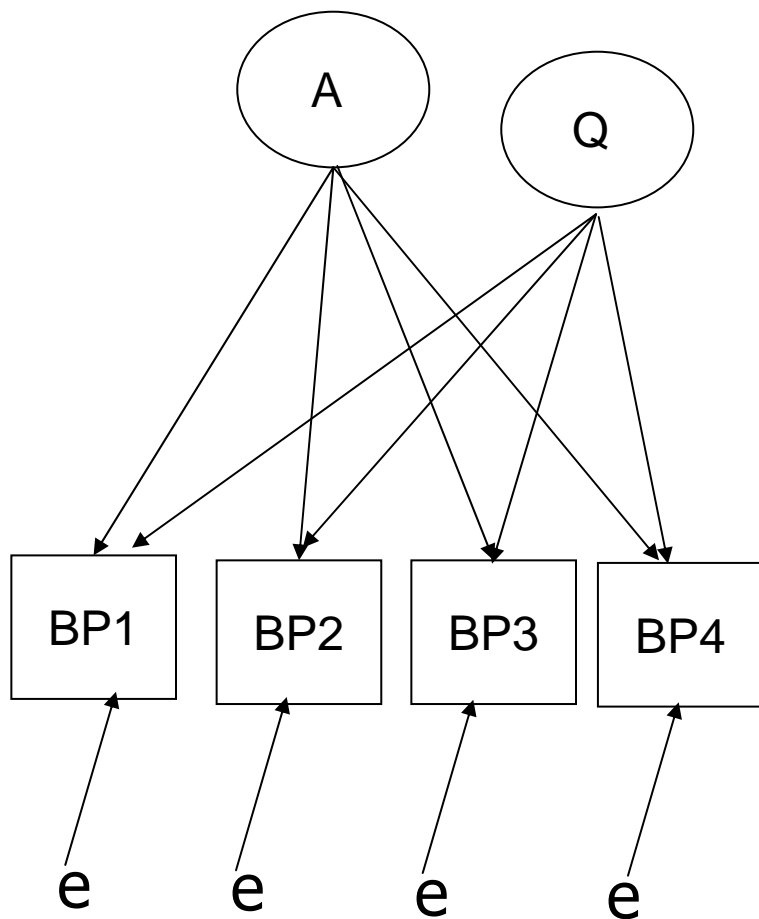

For MZ twins:

$$r(A1, A2) = 1$$

$$r(Q1, Q2) = 1$$

For DZ twins and sibs:

$$r(A1, A2) = 0.5$$

$$r(Q1, Q2) = \text{"pihat"}$$



# Assignment chromosome 11 genome scan

Marker data: 2 cM spacing

Phenotypes in MZ twins and genotyped sib/DZ pairs

Model:

A factor (4 x 1)

Q factor (4 x 1)

E diagonal (4 x 4)

Script:

F:\meike\phneotypic\ACE BP Afactor.mx

Change script and add QTL

# Data and scripts

- ACEBP Elower.mx: 4 variate script for genetic analysis (Cholesky decomposition)
- Modify this script for QTL analysis
- Input files = C11Pxx.prn (a different file for every position)

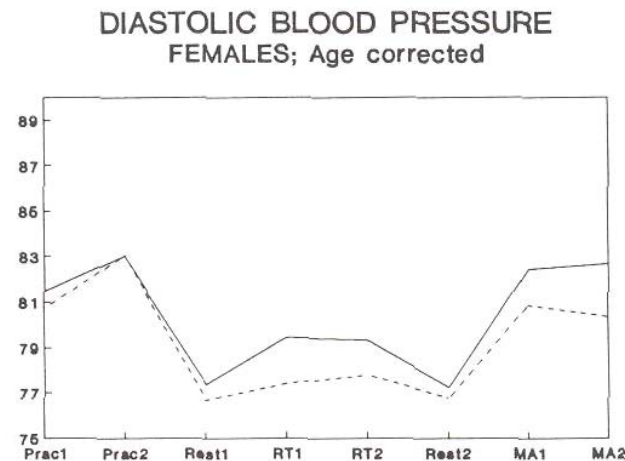
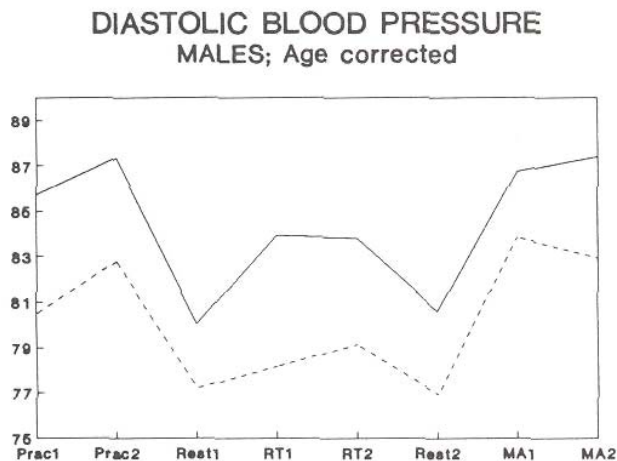
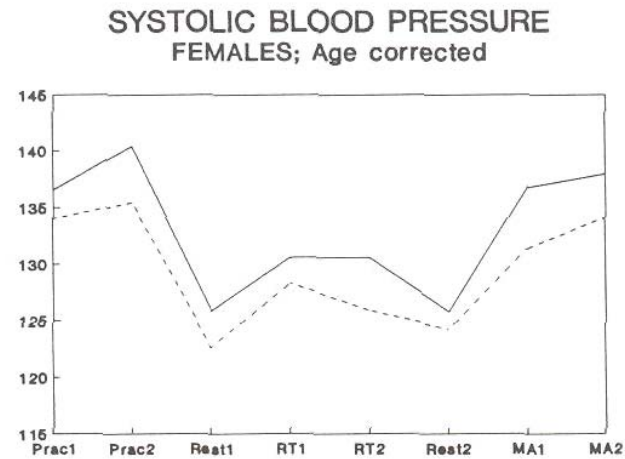
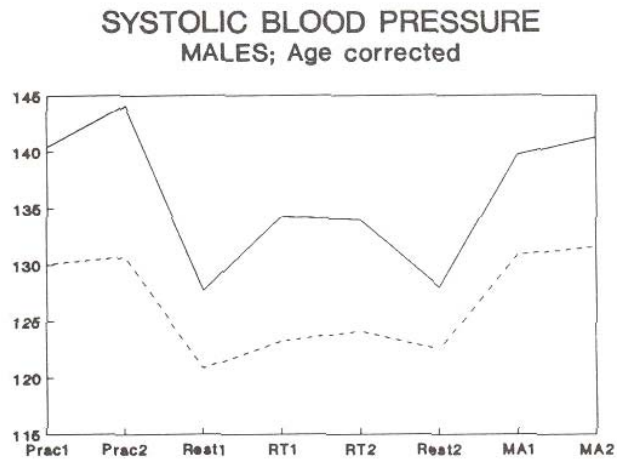

Alpha1-antitrypsin: genotypes at the protease inhibitor (Pi) locus and blood pressure: Dutch parents of twins (solid lines: 130/116 MM males/females, dashed lines 16/22 MZ/MS males/females). Non-MM genotypes have lower BP and lower BP response.

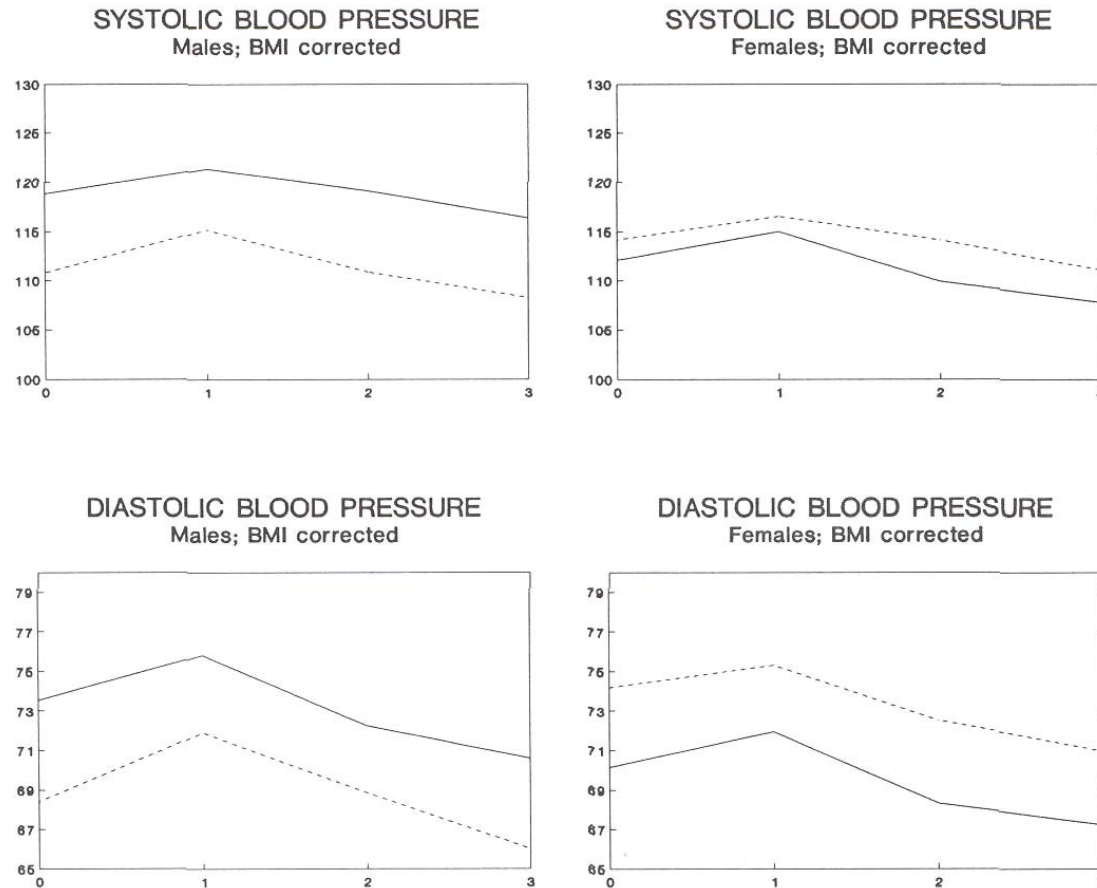

Alpha1-antitrypsin: genotypes at the protease inhibitor (Pi) locus and blood pressure: Australian twins (solid lines: 130/127 MM males/females, dashed lines 23/35 MZ/MS males/females). Non-MM males have lower BP.